

# ESD Protection Diode Array

## Ultra Low Capacitance ESD Protection for High Speed Data Line Protection

### ESDR0502N

The ESDR0502N ultra low capacitance surge protection array is designed to protect high speed data lines from ESD. Ultra-low capacitance and high level of ESD protection makes this device well suited for use in USB 2.0 applications.

#### Features

- Low Capacitance (0.3 pF Typical Between I/O Lines and Ground)
- IEC 61000-4-2 Level 4
- UL Flammability Rating of 94 V-0
- These Devices are Pb-Free and are RoHS Compliant

#### Typical Applications

- High Speed Communication Line Protection
- USB 2.0 High Speed Data Line and Power Line Protection
- Monitors and Flat Panel Displays
- MP3
- Gigabit Ethernet

#### MAXIMUM RATINGS (T<sub>J</sub> = 25°C unless otherwise noted)

Rating	Symbol	Value	Unit
Operating Junction Temperature Range	T <sub>J</sub>	-40 to +125	°C
Peak Power Dissipation 8x20 μs @ T <sub>A</sub> = 25°C (Note 1)	P <sub>pk</sub>	100	W
Peak Power Current 8x20 μs @ T <sub>A</sub> = 25°C (Note 1)	I <sub>pp</sub>	3.0	A
Storage Temperature Range	T <sub>stg</sub>	-55 to +150	°C
Lead Solder Temperature – Maximum (10 Seconds)	T <sub>L</sub>	260	°C
IEC 61000-4-2 Contact (ESD)	ESD	8.0	kV

Stresses exceeding those listed in the Maximum Ratings table may damage the device. If any of these limits are exceeded, device functionality should not be assumed, damage may occur and reliability may be affected.

1. Nonrepetitive current pulse (pin 6 to pin 1).

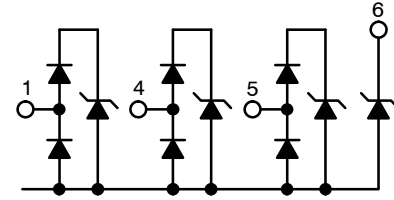

UDFN6  
MU SUFFIX  
CASE 517AA

#### MARKING DIAGRAM



- D = Specific Device Code\*  
(Rotated 90° clockwise)  
M = Date Code & Assembly Location

#### PINOUT

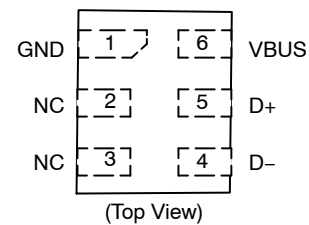

#### ORDERING INFORMATION

Device	Package	Shipping <sup>†</sup>
ESDR0502NMUTAG	UDFN6 (Pb-Free)	3000 / Tape & Reel
ESDR0502NMUTBG	UDFN6 (Pb-Free)	3000 / Tape & Reel

<sup>†</sup>For information on tape and reel specifications, including part orientation and tape sizes, please refer to our Tape and Reel Packaging Specification Brochure, BRD8011/D.

# ESDR0502N

## ELECTRICAL CHARACTERISTICS

( $T_A = 25^\circ\text{C}$  unless otherwise noted)

Symbol	Parameter
$I_{PP}$	Maximum Reverse Peak Pulse Current
$V_C$	Clamping Voltage @ $I_{PP}$
$V_{RWM}$	Working Peak Reverse Voltage
$I_R$	Maximum Reverse Leakage Current @ $V_{RWM}$
$V_{BR}$	Breakdown Voltage @ $I_T$
$I_T$	Test Current
$I_F$	Forward Current
$V_F$	Forward Voltage @ $I_F$
$P_{pk}$	Peak Power Dissipation
$C$	Capacitance @ $V_R = 0$ and $f = 1.0$ MHz

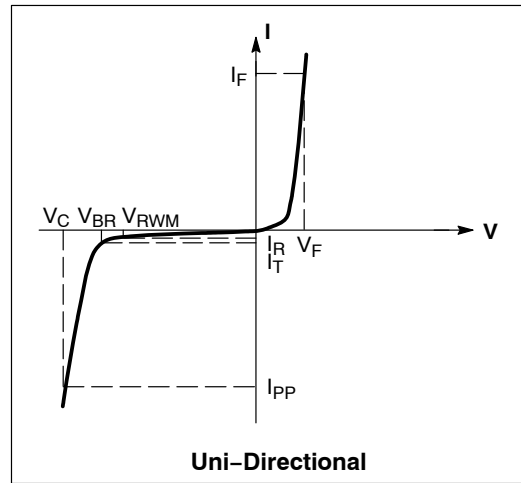

\*See Application Note AND8308/D for detailed explanations of datasheet parameters.

## ELECTRICAL CHARACTERISTICS ( $T_J = 25^\circ\text{C}$ unless otherwise specified)

Parameter	Symbol	Conditions	Min	Typ	Max	Unit
Reverse Working Voltage	$V_{RWM}$	(Note 2)			5.5	V
Breakdown Voltage	$V_{BR}$	$I_T = 1$ mA, (Note 3)	6.0			V
Reverse Leakage Current	$I_R$	$V_{RWM} = 5.5$ V			1.0	$\mu\text{A}$
ESD Clamping Voltage	$V_C$	Per IEC61000-4-2 (Note 4)	See Figures 1 & 2			
Junction Capacitance	$C_J$	$V_R = 0$ V, $f = 1$ MHz between I/O Pins and GND		0.3	0.6	pF
Junction Capacitance	$C_J$	$V_R = 0$ V, $f = 1$ MHz between I/O Pins		0.3	0.6	pF

Product parametric performance is indicated in the Electrical Characteristics for the listed test conditions, unless otherwise noted. Product performance may not be indicated by the Electrical Characteristics if operated under different conditions.

- Surge protection devices are normally selected according to the working peak reverse voltage ( $V_{RWM}$ ), which should be equal or greater than the DC or continuous peak operating voltage level.
- $V_{BR}$  is measured at pulse test current  $I_T$ .
- For test procedure see Figures 3 and 4 and Application Note AND8307/D.

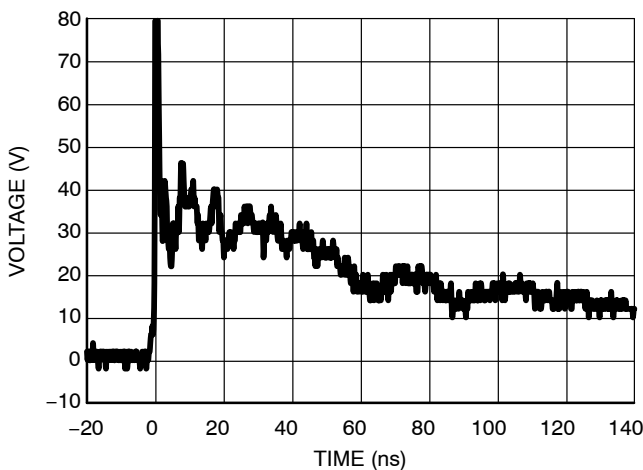

**Figure 1. ESD Clamping Voltage Screenshot Positive 8 kV Contact per IEC61000-4-2**

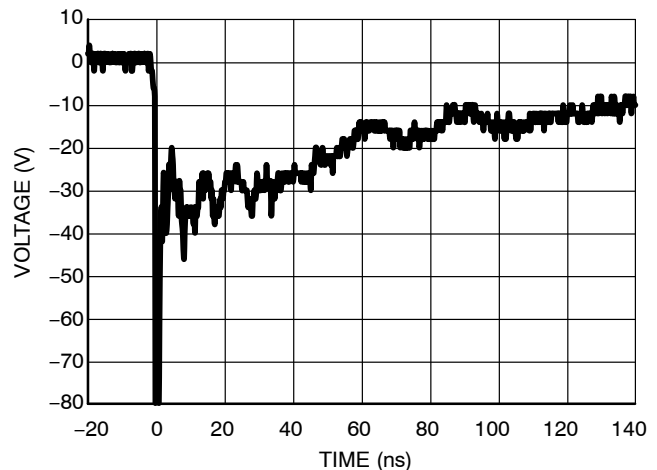

**Figure 2. ESD Clamping Voltage Screenshot Negative 8 kV Contact per IEC61000-4-2**

# ESDR0502N

## IEC 61000-4-2 Spec.

Level	Test Voltage (kV)	First Peak Current (A)	Current at 30 ns (A)	Current at 60 ns (A)
1	2	7.5	4	2
2	4	15	8	4
3	6	22.5	12	6
4	8	30	16	8



Figure 3. IEC61000-4-2 Spec

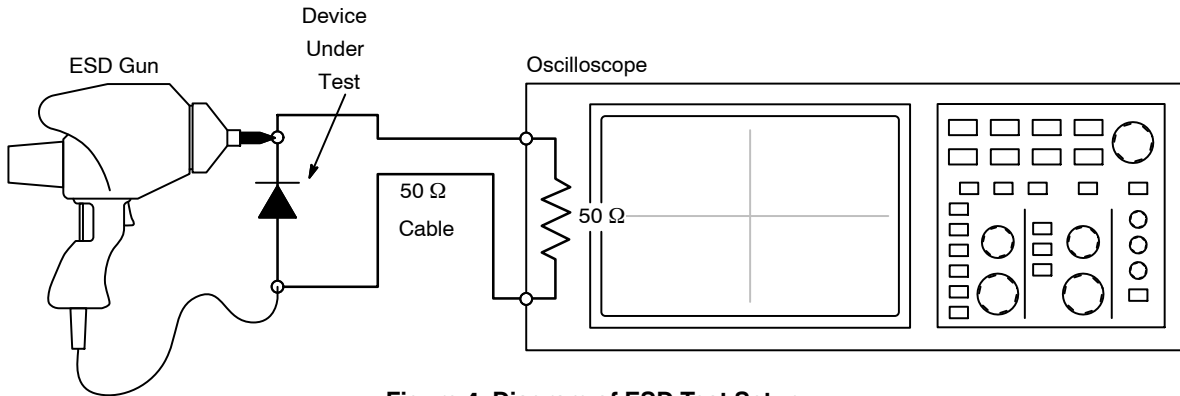

Figure 4. Diagram of ESD Test Setup

The following is taken from Application Note AND8308/D – Interpretation of Datasheet Parameters for ESD Devices.

### ESD Voltage Clamping

For sensitive circuit elements it is important to limit the voltage that an IC will be exposed to during an ESD event to as low a voltage as possible. The ESD clamping voltage is the voltage drop across the ESD protection diode during an ESD event per the IEC61000-4-2 waveform. Since the IEC61000-4-2 was written as a pass/fail spec for larger

systems such as cell phones or laptop computers it is not clearly defined in the spec how to specify a clamping voltage at the device level. **onsemi** has developed a way to examine the entire voltage waveform across the ESD protection diode over the time domain of an ESD pulse in the form of an oscilloscope screenshot, which can be found on the datasheets for all ESD protection diodes. For more information on how **onsemi** creates these screenshots and how to interpret them please refer to AND8307/D.

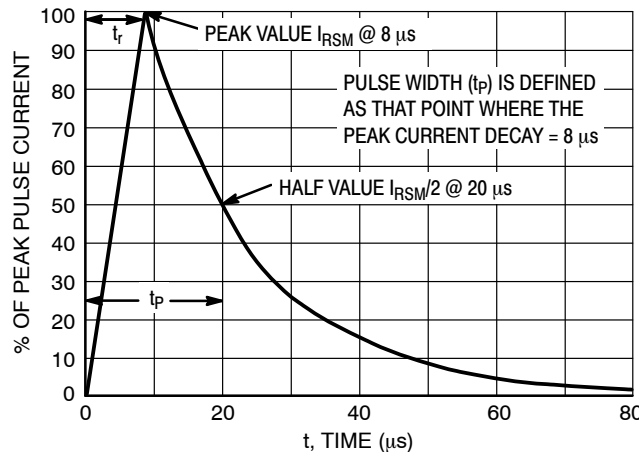

Figure 5. 8 x 20 μs Pulse Waveform

# ESDR0502N

## APPLICATION INFORMATION

### Protecting USB 2.0 Interfaces

The USB interface consists of Data (D- and D+) lines and a 5.5 V bus, which are all vulnerable to ESD and cable discharge events. Each ESDR0502N device will protect the four USB connections ( $V_{CC}$ , D+, D-, and GND) of one USB port. When the voltage on the data lines exceed the

breakdown voltage of the protection device, the internal rectifiers are forward biased conducting the transient current away from the protected controller chip. The surge protection diode suppresses ESD strikes directly on the voltage bus and directs the surge to ground, protecting both the power and data pins.

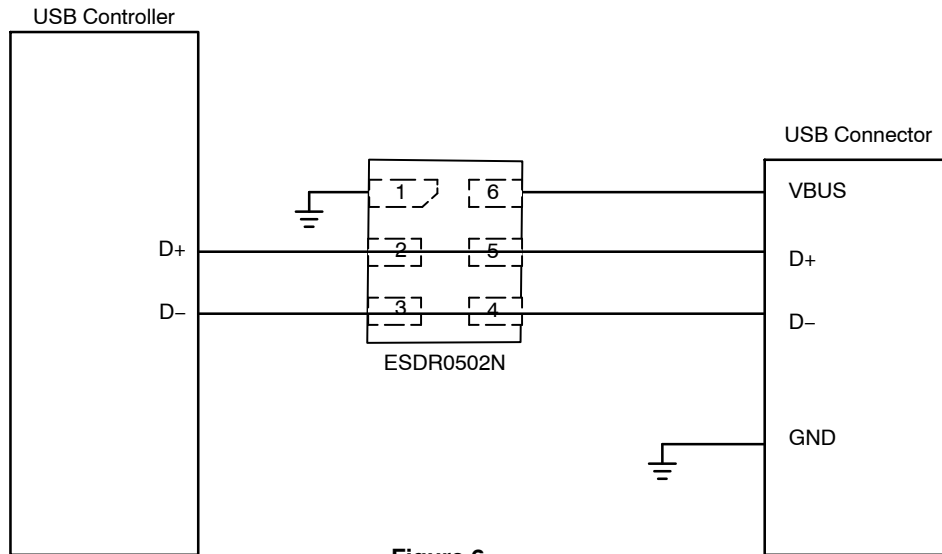

Figure 6.

# MECHANICAL CASE OUTLINE PACKAGE DIMENSIONS



UDFN6, 1.2x1.0, 0.4P  
CASE 517AA  
ISSUE D

DATE 03 SEP 2010



- NOTES:
1. DIMENSIONING AND TOLERANCING PER ASME Y14.5M, 1994.
  2. CONTROLLING DIMENSION: MILLIMETERS.
  3. DIMENSION b APPLIES TO PLATED TERMINAL AND IS MEASURED BETWEEN 0.25 AND 0.30 mm FROM TERMINAL.
  4. COPLANARITY APPLIES TO THE EXPOSED PAD AS WELL AS THE TERMINALS.

MILLIMETERS		
DIM	MIN	MAX
A	0.45	0.55
A1	0.00	0.05
A3	0.127	REF
b	0.15	0.25
D	1.20	BSC
E	1.00	BSC
e	0.40	BSC
L	0.30	0.40
L1	0.00	0.15
L2	0.40	0.50

### GENERIC MARKING DIAGRAM\*



X = Specific Device Code  
M = Date Code

\*This information is generic. Please refer to device data sheet for actual part marking. Pb-Free indicator, "G" or microdot "▪", may or may not be present.

### MOUNTING FOOTPRINT\*



DIMENSIONS: MILLIMETERS

\*For additional information on our Pb-Free strategy and soldering details, please download the ON Semiconductor Soldering and Mounting Techniques Reference Manual, SOLDERRM/D.

<b>DOCUMENT NUMBER:</b>	<b>98AON22068D</b>	Electronic versions are uncontrolled except when accessed directly from the Document Repository. Printed versions are uncontrolled except when stamped "CONTROLLED COPY" in red.
<b>DESCRIPTION:</b>	<b>6 PIN UDFN, 1.2X1.0, 0.4P</b>	<b>PAGE 1 OF 1</b>

onsemi and ONsemi are trademarks of Semiconductor Components Industries, LLC dba onsemi or its subsidiaries in the United States and/or other countries. onsemi reserves the right to make changes without further notice to any products herein. onsemi makes no warranty, representation or guarantee regarding the suitability of its products for any particular purpose, nor does onsemi assume any liability arising out of the application or use of any product or circuit, and specifically disclaims any and all liability, including without limitation special, consequential or incidental damages. onsemi does not convey any license under its patent rights nor the rights of others.

**onsemi**, **Onsemi**, and other names, marks, and brands are registered and/or common law trademarks of Semiconductor Components Industries, LLC dba "**onsemi**" or its affiliates and/or subsidiaries in the United States and/or other countries. **onsemi** owns the rights to a number of patents, trademarks, copyrights, trade secrets, and other intellectual property. A listing of **onsemi**'s product/patent coverage may be accessed at [www.onsemi.com/site/pdf/Patent-Marking.pdf](http://www.onsemi.com/site/pdf/Patent-Marking.pdf). **onsemi** reserves the right to make changes at any time to any products or information herein, without notice. The information herein is provided "as-is" and **onsemi** makes no warranty, representation or guarantee regarding the accuracy of the information, product features, availability, functionality, or suitability of its products for any particular purpose, nor does **onsemi** assume any liability arising out of the application or use of any product or circuit, and specifically disclaims any and all liability, including without limitation special, consequential or incidental damages. Buyer is responsible for its products and applications using **onsemi** products, including compliance with all laws, regulations and safety requirements or standards, regardless of any support or applications information provided by **onsemi**. "Typical" parameters which may be provided in **onsemi** data sheets and/or specifications can and do vary in different applications and actual performance may vary over time. All operating parameters, including "Typicals" must be validated for each customer application by customer's technical experts. **onsemi** does not convey any license under any of its intellectual property rights nor the rights of others. **onsemi** products are not designed, intended, or authorized for use as a critical component in life support systems or any FDA Class 3 medical devices or medical devices with a same or similar classification in a foreign jurisdiction or any devices intended for implantation in the human body. Should Buyer purchase or use **onsemi** products for any such unintended or unauthorized application, Buyer shall indemnify and hold **onsemi** and its officers, employees, subsidiaries, affiliates, and distributors harmless against all claims, costs, damages, and expenses, and reasonable attorney fees arising out of, directly or indirectly, any claim of personal injury or death associated with such unintended or unauthorized use, even if such claim alleges that **onsemi** was negligent regarding the design or manufacture of the part. **onsemi** is an Equal Opportunity/Affirmative Action Employer. This literature is subject to all applicable copyright laws and is not for resale in any manner.

## ADDITIONAL INFORMATION

### TECHNICAL PUBLICATIONS:

Technical Library: [www.onsemi.com/design/resources/technical-documentation](http://www.onsemi.com/design/resources/technical-documentation)  
onsemi Website: [www.onsemi.com](http://www.onsemi.com)

### ONLINE SUPPORT: [www.onsemi.com/support](http://www.onsemi.com/support)

For additional information, please contact your local Sales Representative at [www.onsemi.com/support/sales](http://www.onsemi.com/support/sales)