

MM	IN
25.4	.010
11.07	.437
12.70	.500
23.77	.937
37.50	1.281
50.80	1.998
82.55	3.250

55013

REF
MSB

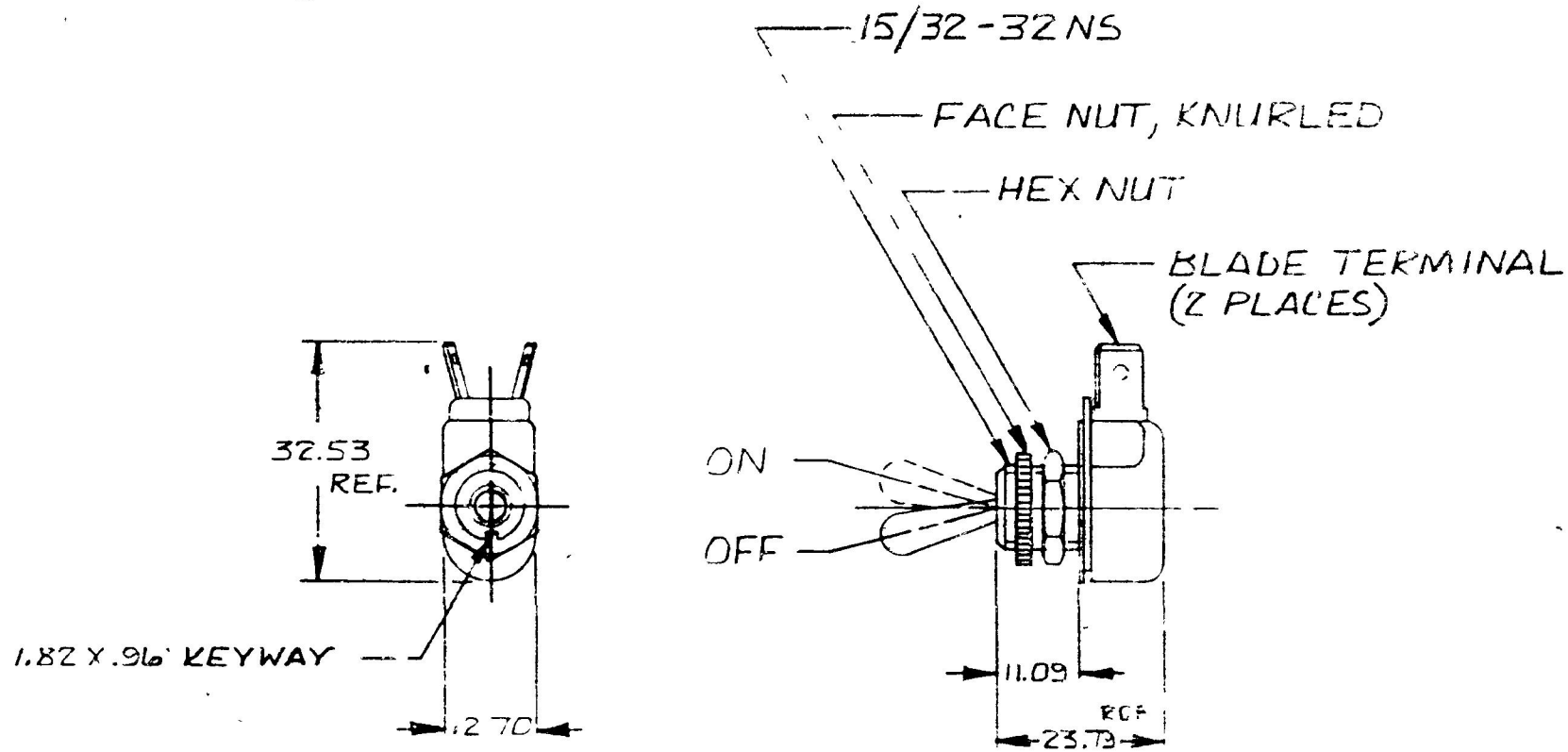

METRIC

DO NOT SCALE

LET	WAS	DATE	BY	LET	WAS	DATE	BY	MATERIAL	DRAWN	CHECKED	APPR'D	SCALE	DATE DRAWN
								#	PJB			1:1	8-28-56
								FINISH					DATE BLUEPRINT
								TOLERANCES	 Cole Hersee Co. <small>20 013 COLBY AVENUE, BOSTON 10, MASS.</small>				
							DECIMAL ±						
				E	REDRAWN	10-19-81	(B)	METRIC ± .25					55013
													TOGGLE SWITCH

CH-188(4-78)