

ETH-127-14-11-S-H1

High Temperature Peltier Cooler Module

Data sheet

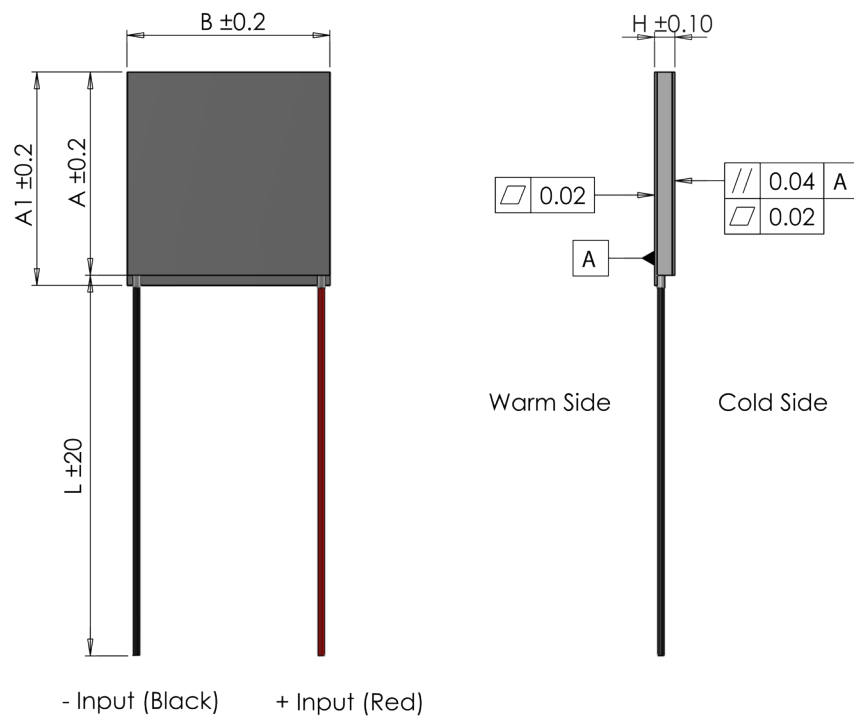

I_{max}	[A]	9.2
V_{max}	[Vdc]	15.8
$P_c \text{ max}$	[W]	77
ΔT_{max}	[°C]	70
A	[mm]	40
A1	[mm]	40
B	[mm]	40
H	[mm]	3.8
L	[mm]	100
Wire	AWG	n/a

- Silicone sealed
- (At hot side temperature $T_h = 25^\circ\text{C} / 298\text{K}$, under dry N_2)
- $P_c \text{ max}$ = Cooling power at $\Delta T = 0$ and $I = I_{max}$
- ΔT_{max} = Temperature difference at $I = I_{max}$ and $P_c = 0$
- Max hot side temperature $T_h = 200^\circ\text{C}$ for best long term performance
- Max mounting pressure: 1.5MPa
- Wires: UL-style 1569, 105°C (Unstripped)



ETH-127-14-II-S-HI

High Temperature Peltier Cooler Module

Data sheet - At hot side temperature 25°C

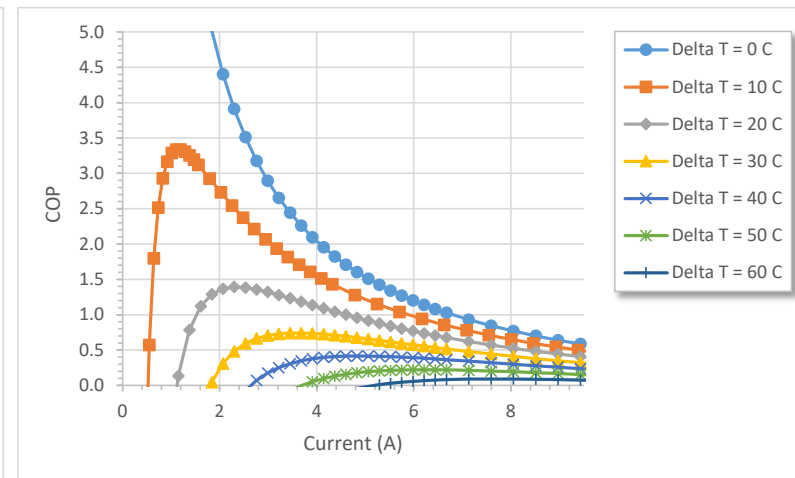
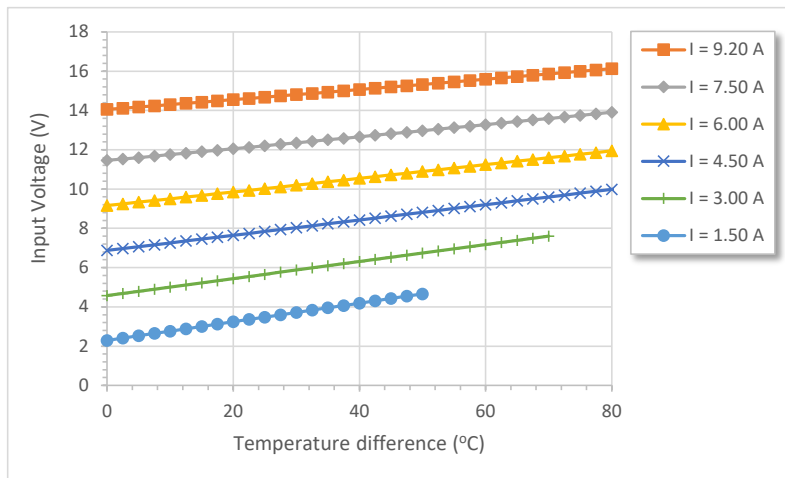
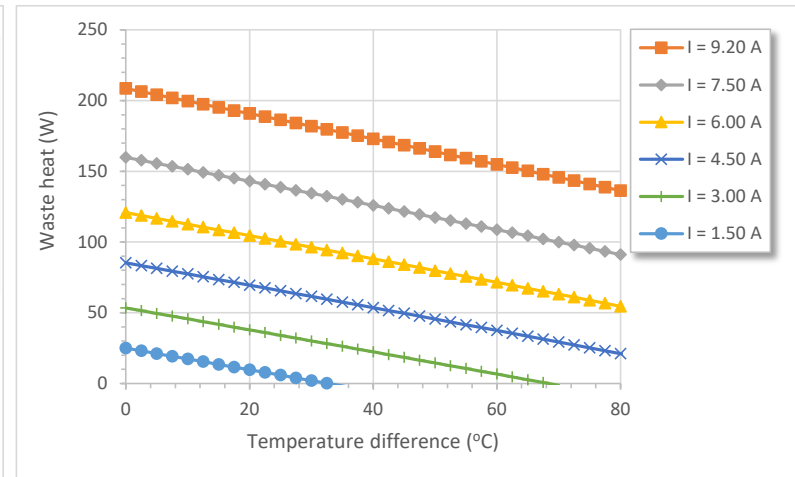
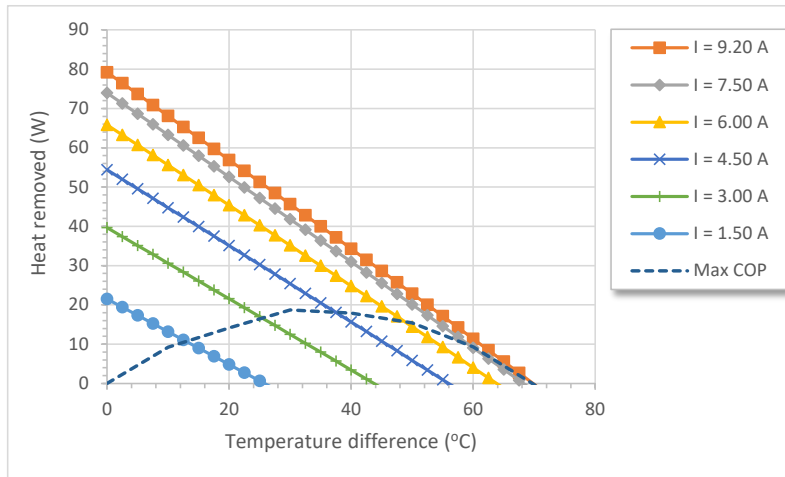

*Note - Waste heat = Heat out of hot side



ETH-I27-14-II-S-HI

High Temperature Peltier Cooler Module

Data sheet - At hot side temperature 50°C

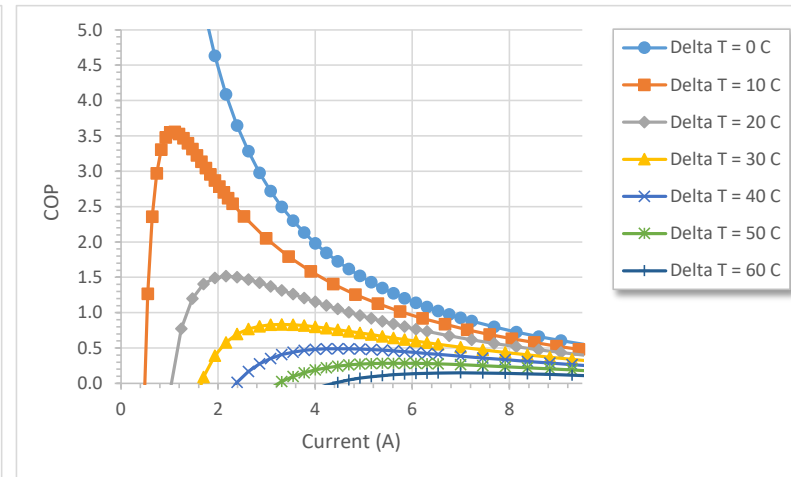
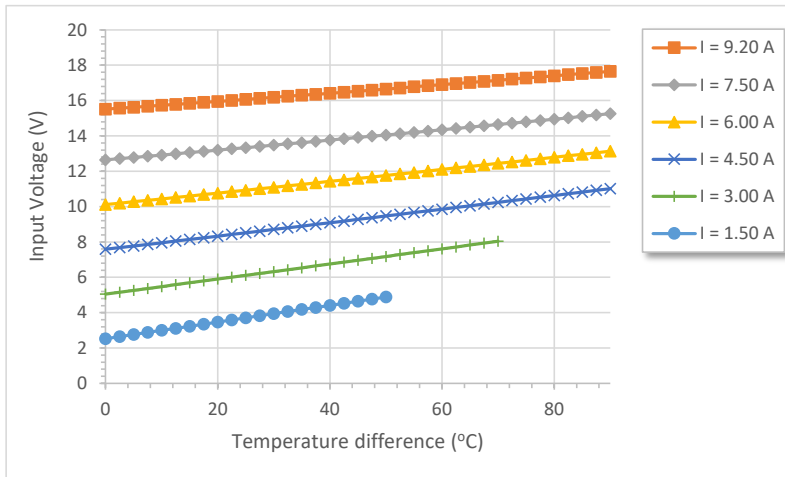
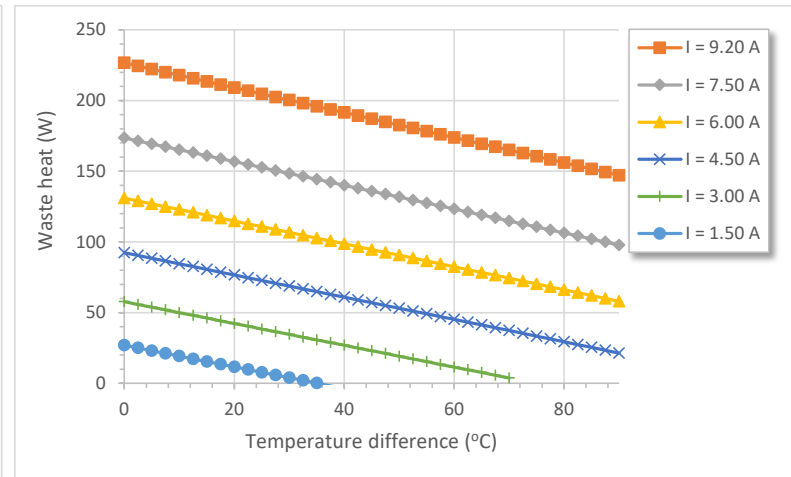
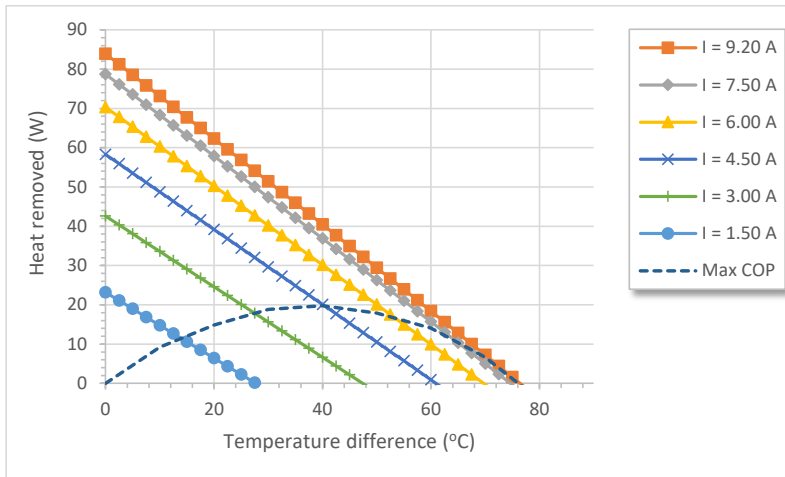

*Note - Waste heat = Heat out of hot side



ETH-127-14-II-S-HI

High Temperature Peltier Cooler Module

Data sheet - At hot side temperature 75°C

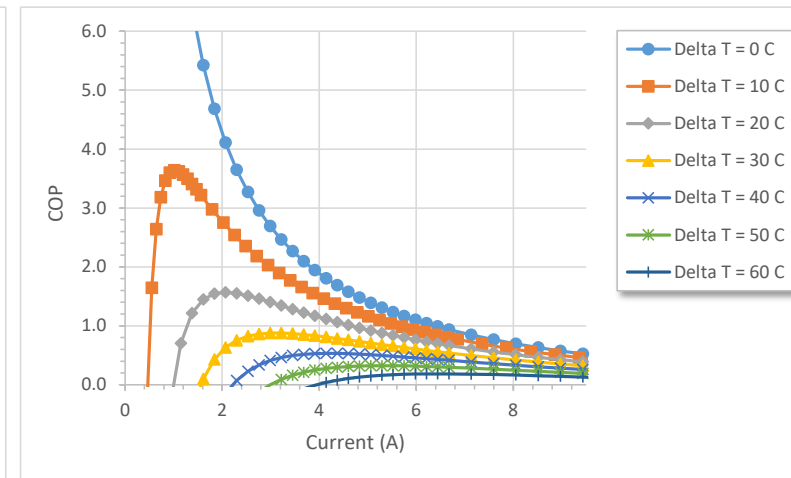
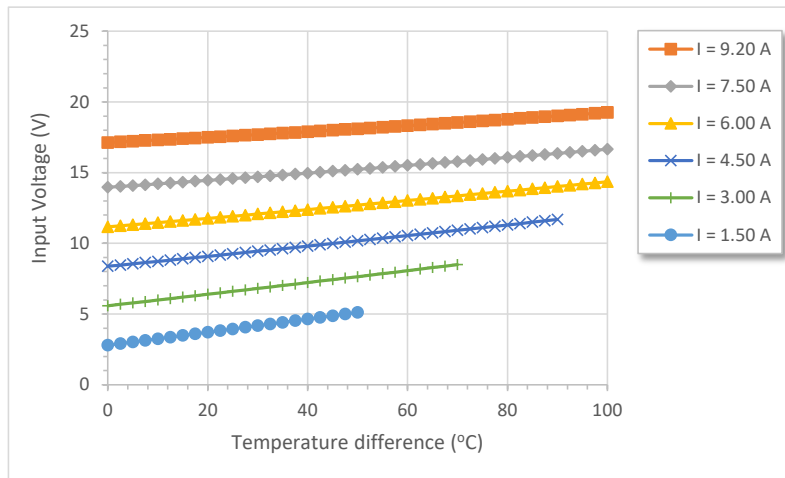
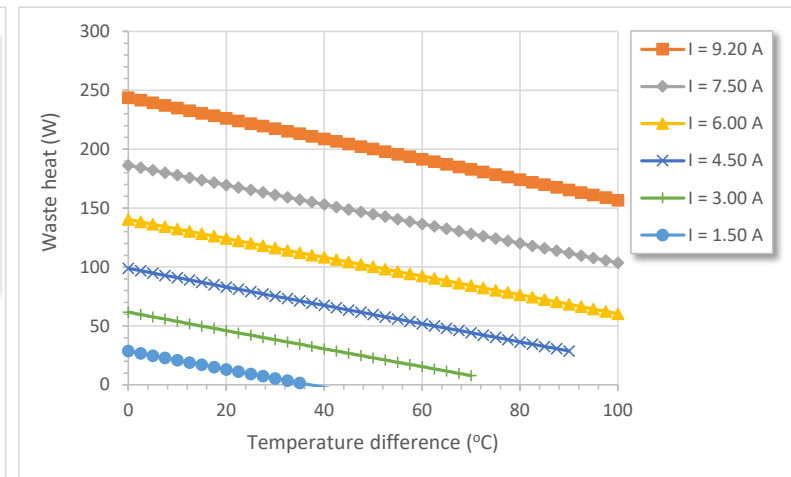
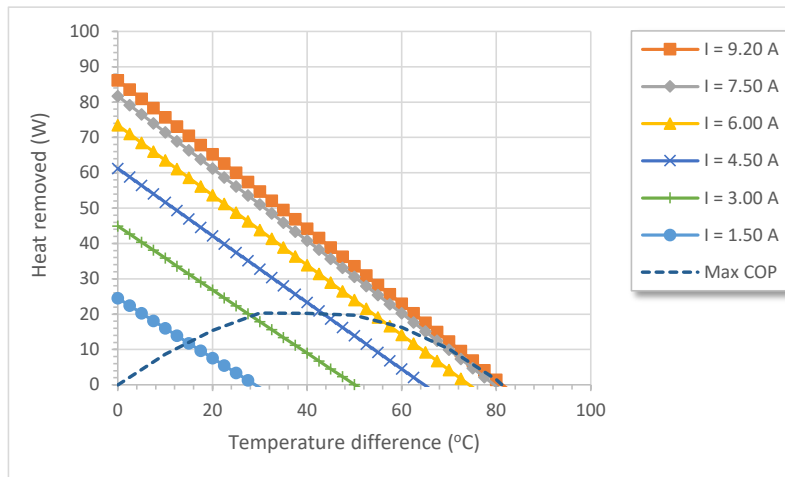

*Note - Waste heat = Heat out of hot side

