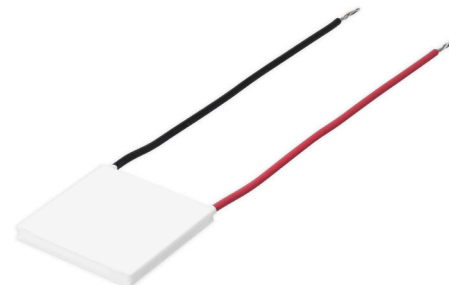

**SERIES:** CP100 | **DESCRIPTION:** PELTIER MODULE

**FEATURES**

- arcTEC™ structure on select models
- enhanced reliability for high thermal cycling
- superior thermal performance
- silicon sealed
- wide  $\Delta T_{max}$
- precise temperature control
- solid state construction

**MODEL**

	input voltage <sup>1</sup>	input current <sup>2</sup>	internal resistance <sup>3</sup>	output Qmax <sup>4</sup>		output $\Delta T_{max}$ <sup>5</sup>	
	max [Vdc]	max [A]	typ [ $\Omega \pm 10\%$ ]	$T_h = 27^\circ\text{C}$ [W]	$T_h = 50^\circ\text{C}$ [W]	$T_h = 27^\circ\text{C}$ [°C]	$T_h = 50^\circ\text{C}$ [°C]
CP10205033	9.6	10	0.71	56.2	62	68	75
CP103033 <sup>6</sup>	11.8	10	0.88	69	75	70	77
CP10304033 <sup>6</sup>	15	10	1.13	89	97	70	77
CP10415273 <sup>6</sup>	4.9	10	0.37	28	30	70	77
CP105559415 <sup>6</sup>	24.6	10	1.82	140	154	70	77

Notes: 1. Maximum voltage at  $\Delta T_{max}$  and  $T_h = 27^\circ\text{C}$   
 2. Maximum current to achieve  $\Delta T_{max}$   
 3. Measured by AC 4-terminal method at  $25^\circ\text{C}$   
 4. Maximum heat absorbed at cold side occurs at  $I_{max}$ ,  $V_{max}$ , and  $\Delta T = 0^\circ\text{C}$   
 5. Maximum temperature difference occurs at  $I_{max}$ ,  $V_{max}$ , and  $Q = 0\text{W}$  ( $\Delta T_{max}$  measured in a vacuum at 1.3 Pa)  
 6. Designed with arcTEC™ structure.

## SPECIFICATIONS

parameter	conditions/description	min	typ	max	units
solder melting temperature	connection between thermoelectric pairs	235			°C
assembly compression				1	MPa
RoHS	yes				

## MECHANICAL DRAWING

units: mm

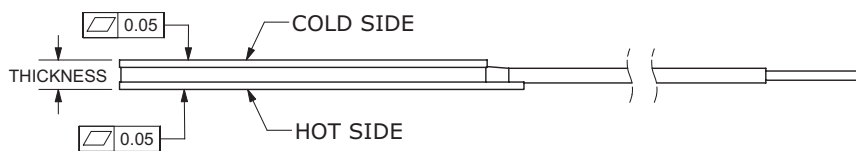

	MATERIAL	PLATING
ceramic plate	96% AL <sub>2</sub> O <sub>3</sub>	
wire leads [CP10415273]	18 AWG	tin
wire leads [all other models]	20 AWG	tin
sealer	silicon rubber 703 RTV (between cold and hot side plates)	
joint cover	silicon rubber 703 RTV	
marking	P/N & S/N printed on cold side surface	

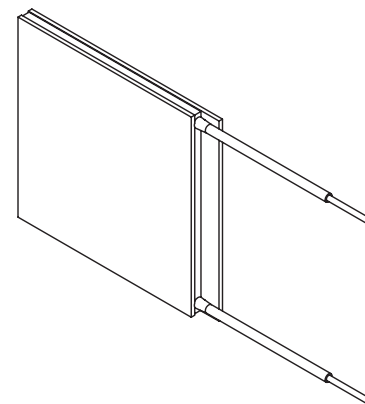
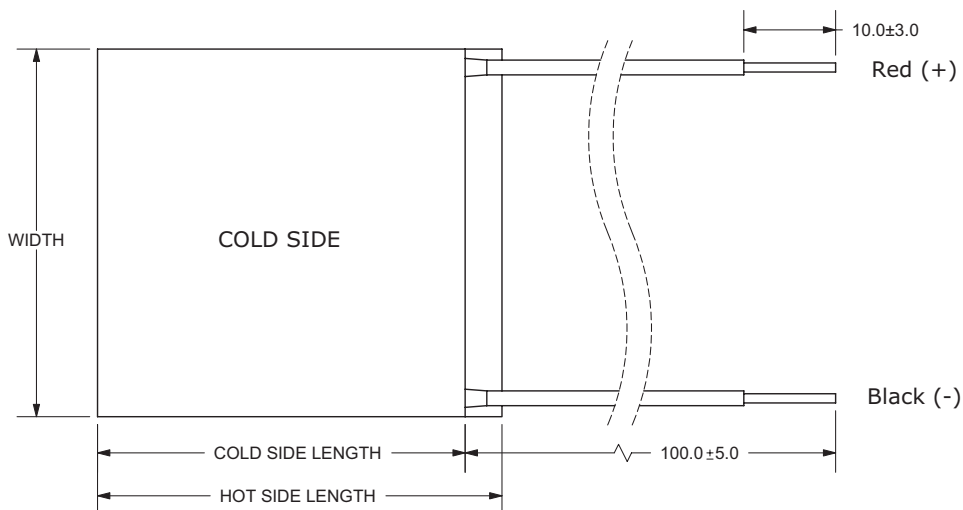

MODEL NO.	HOT SIDE LENGTH [mm]	COLD SIDE LENGTH [mm]	WIDTH [mm]	THICKNESS [mm]
CP10205033	20 ±0.3	20 ±0.3	50 ±0.3	3.3 ±0.1
CP103033	30 ±0.3	30 ±0.3	30 ±0.3	3.3 ±0.1
CP10304033	30 ±0.3	30 ±0.3	40 ±0.3	3.3 ±0.1
CP10415273	57 ±0.3	52 ±0.3	41 ±0.3	7.3 ±0.1
CP105559415	59 ±0.3	55 ±0.3	55 ±0.3	4.15 ±0.1

## CP10205033 PERFORMANCE (Th=27°C)

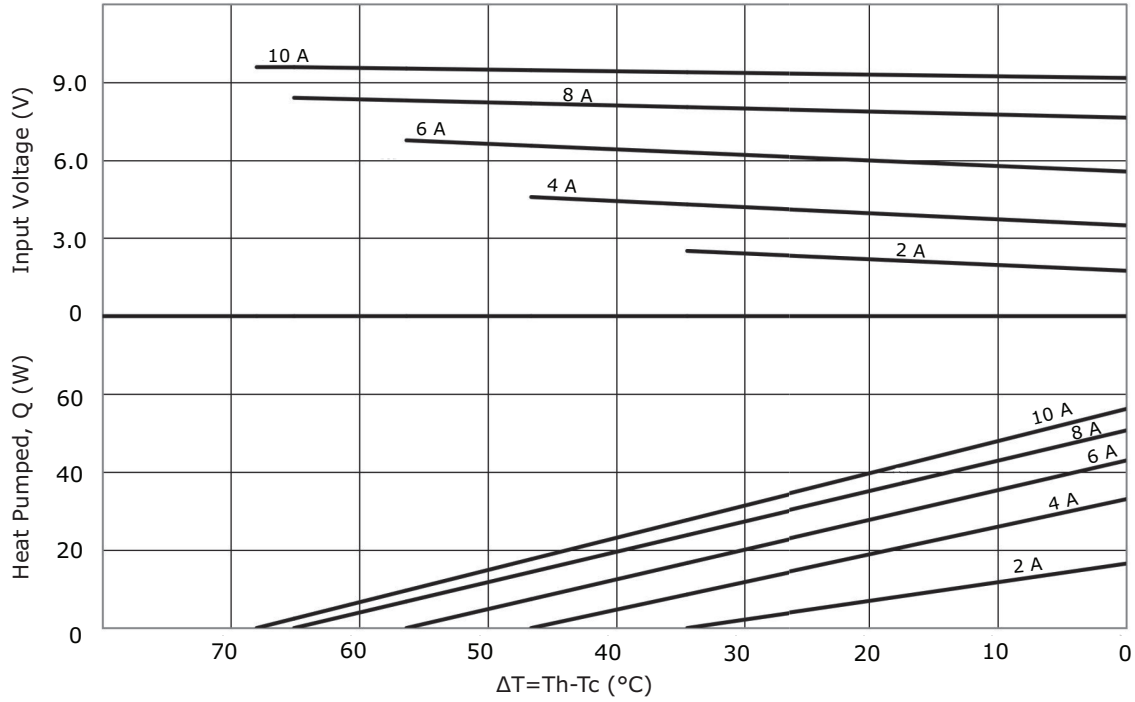

## CP10205033 PERFORMANCE (Th=50°C)

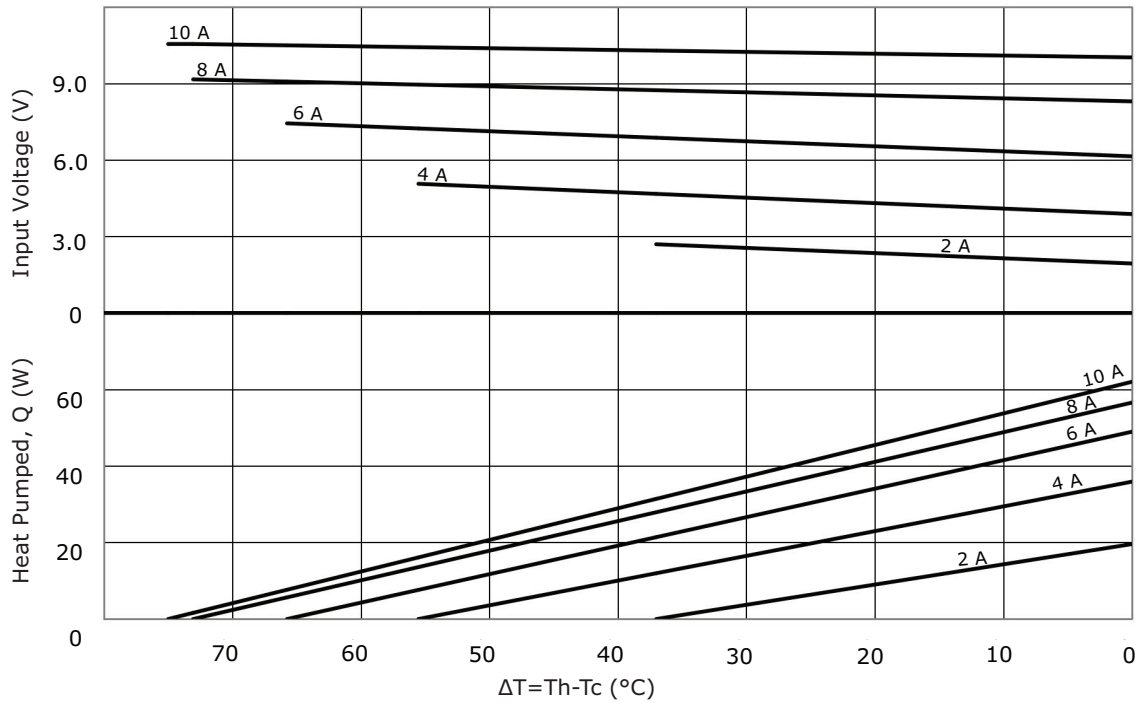

## CP103033 PERFORMANCE (Th=27°C)

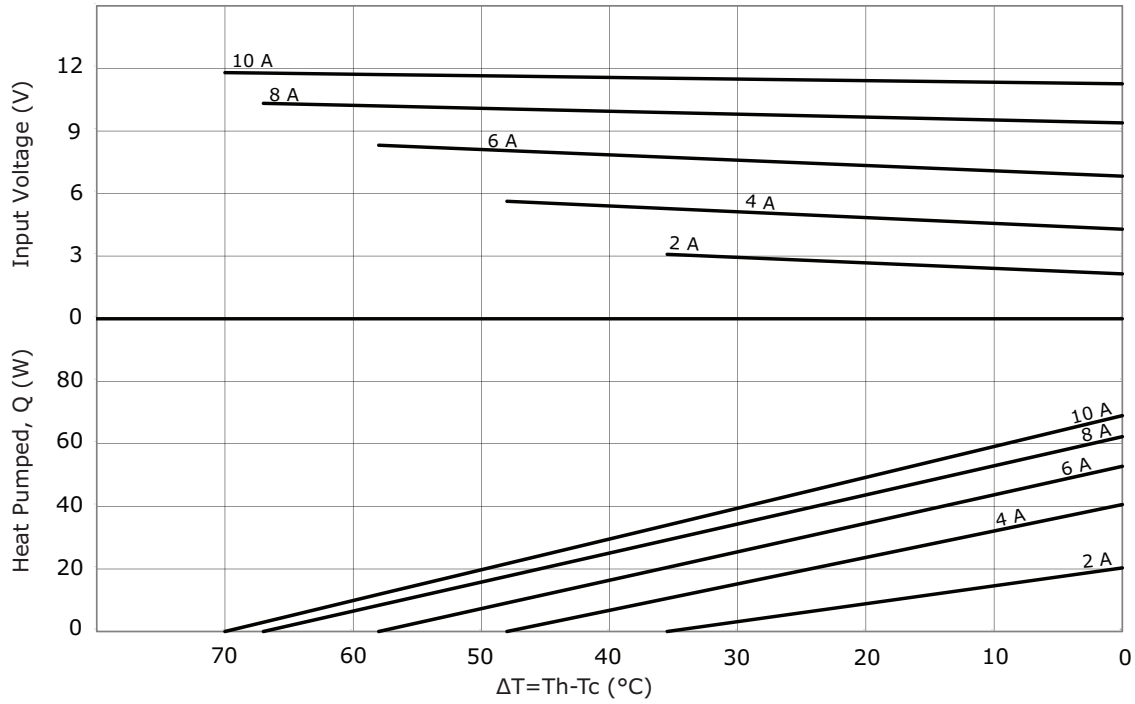

## CP103033 PERFORMANCE (Th=50°C)

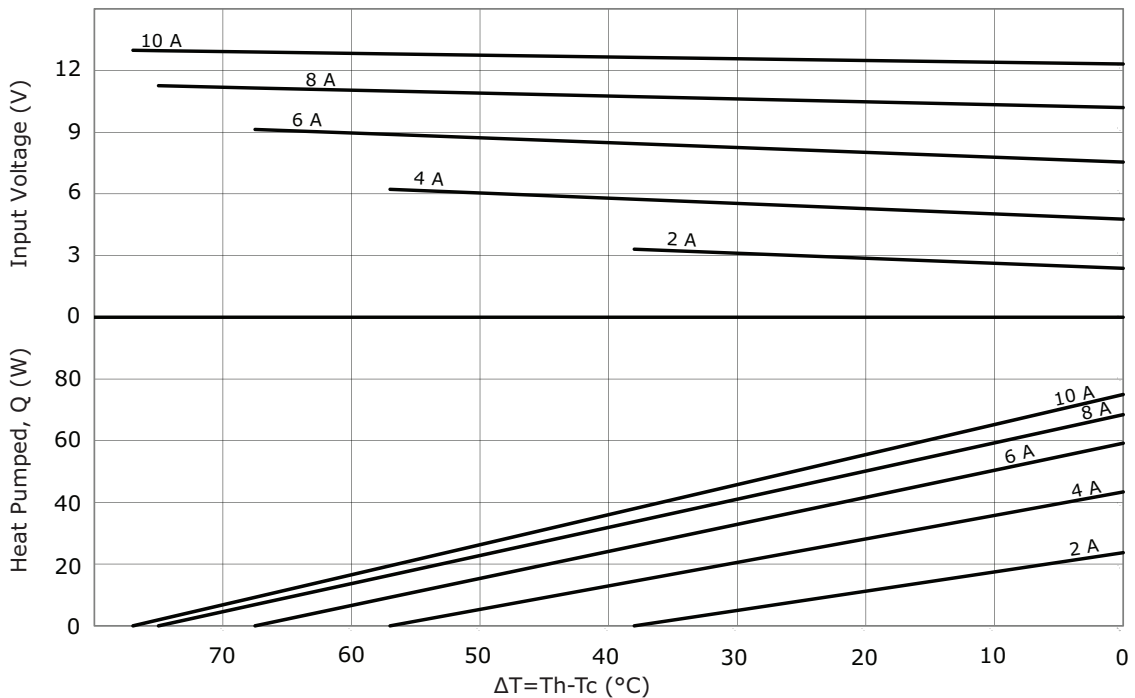

## CP10304033 PERFORMANCE (Th=27°C)

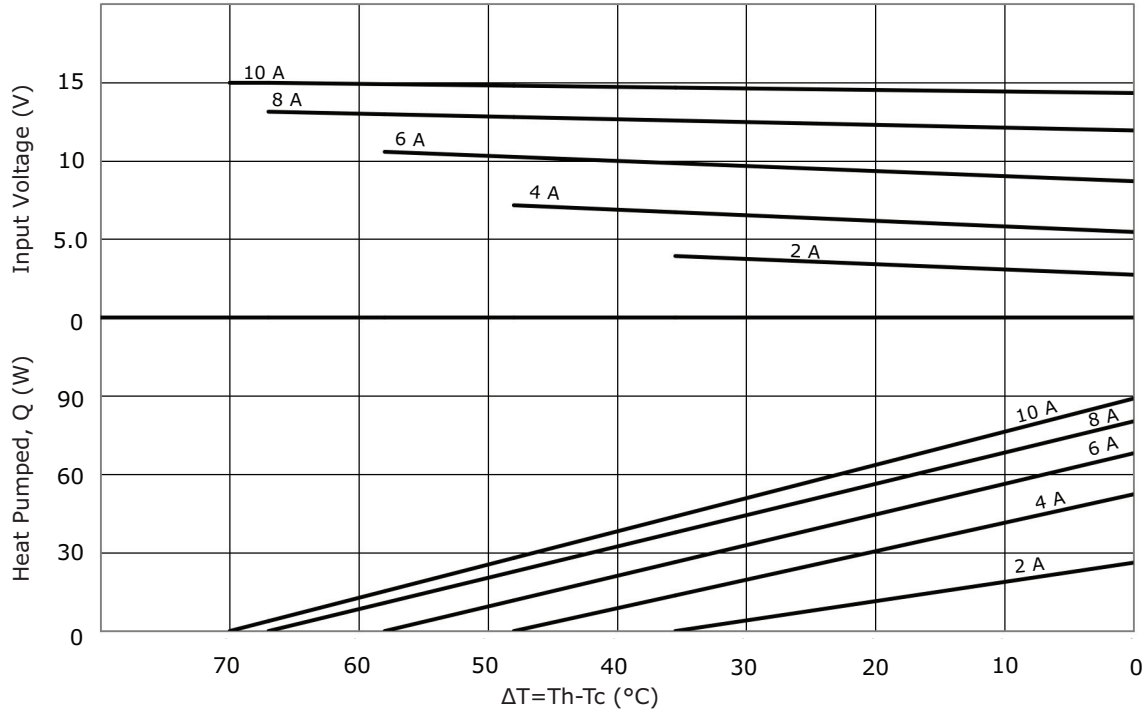

## CP10304033 PERFORMANCE (Th=50°C)

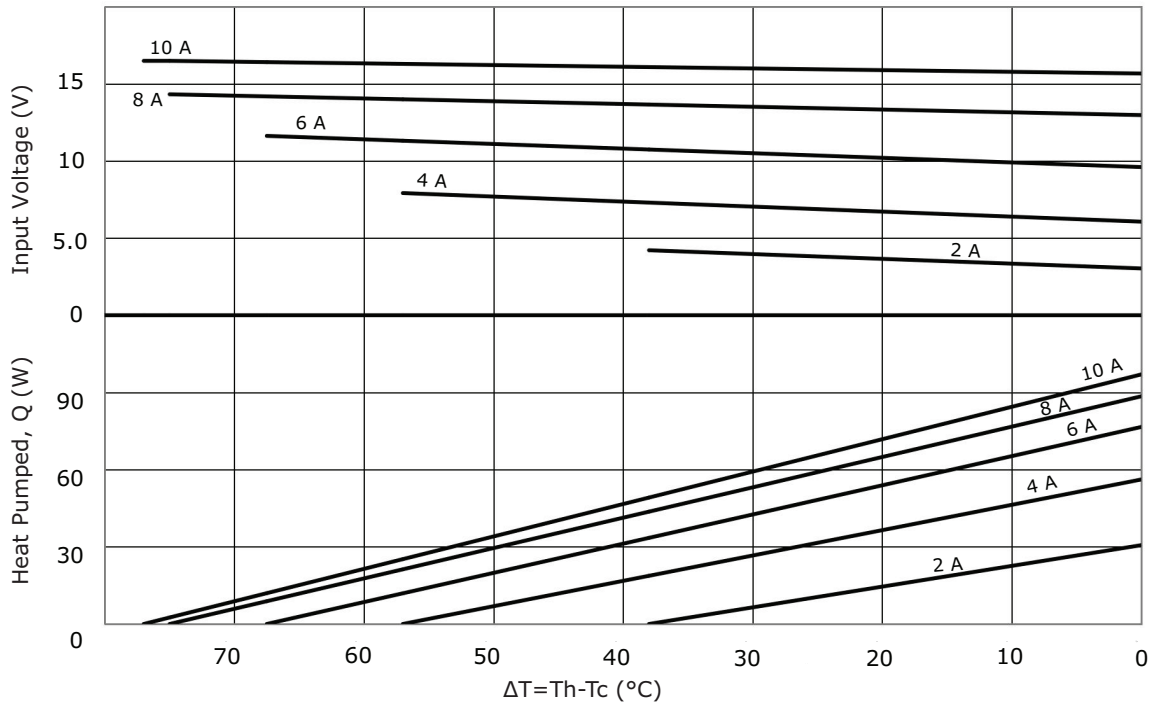

## CP10415273 PERFORMANCE (Th=27°C)

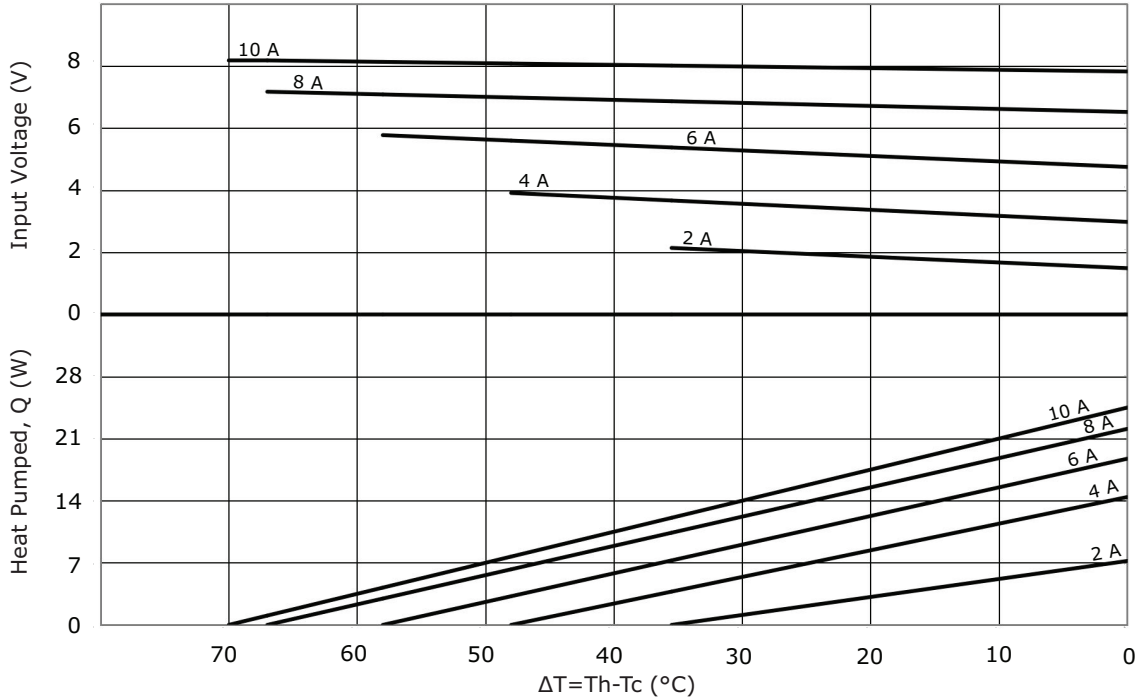

## CP10415273 PERFORMANCE (Th=50°C)

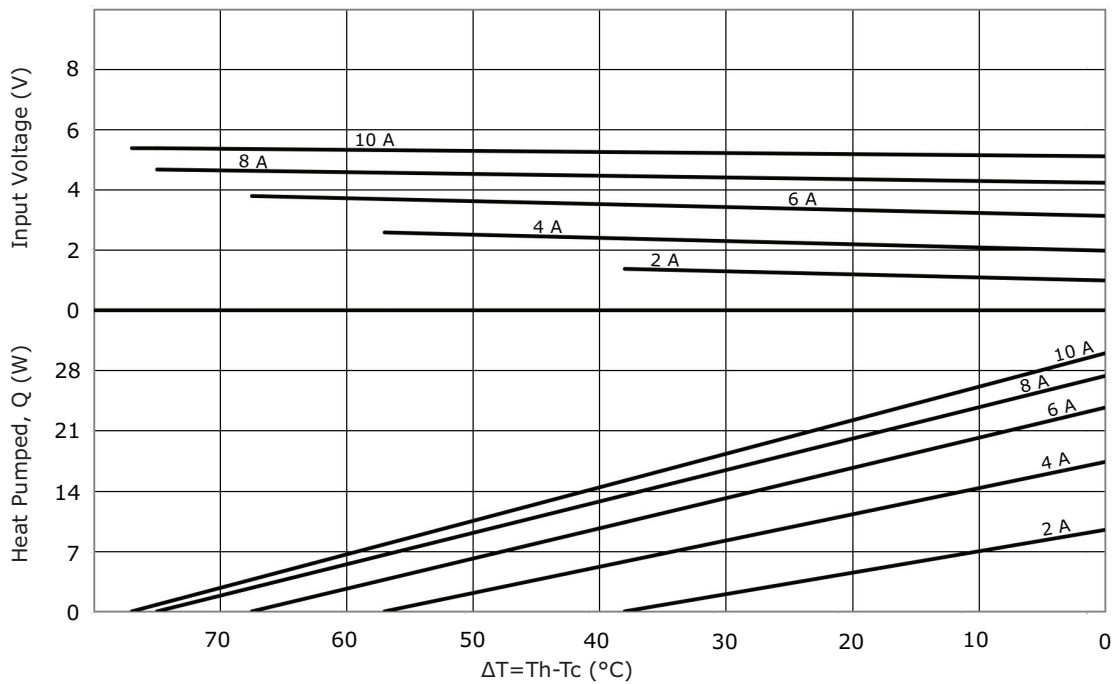

## CP10559415 PERFORMANCE (Th=27°C)

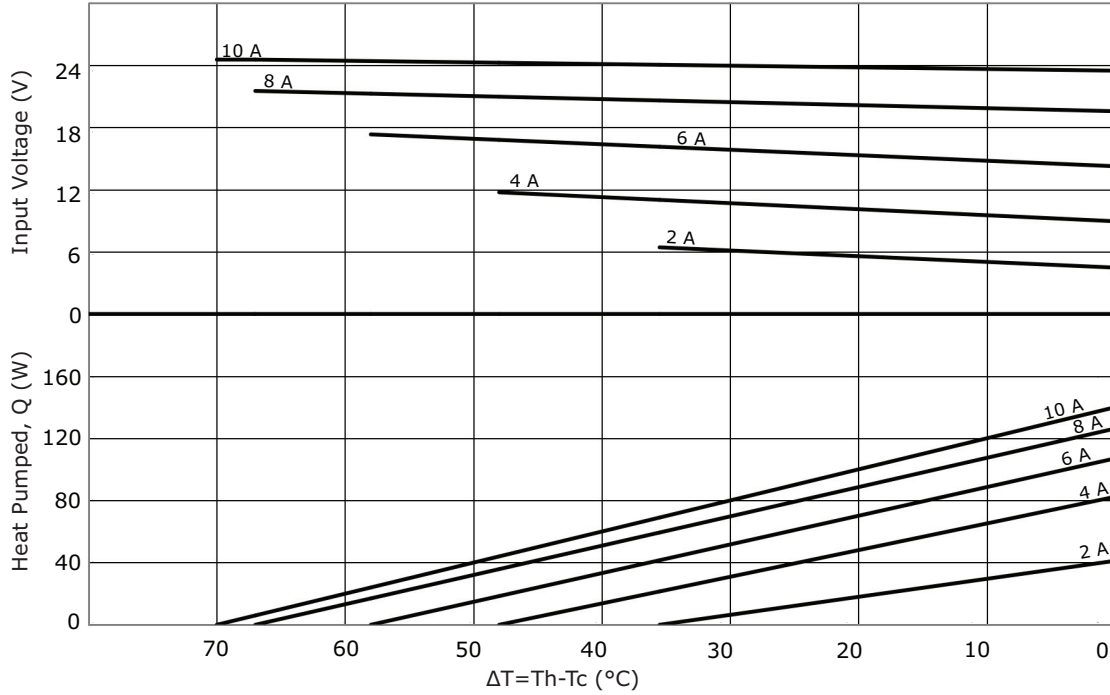

## CP10559415 PERFORMANCE (Th=50°C)

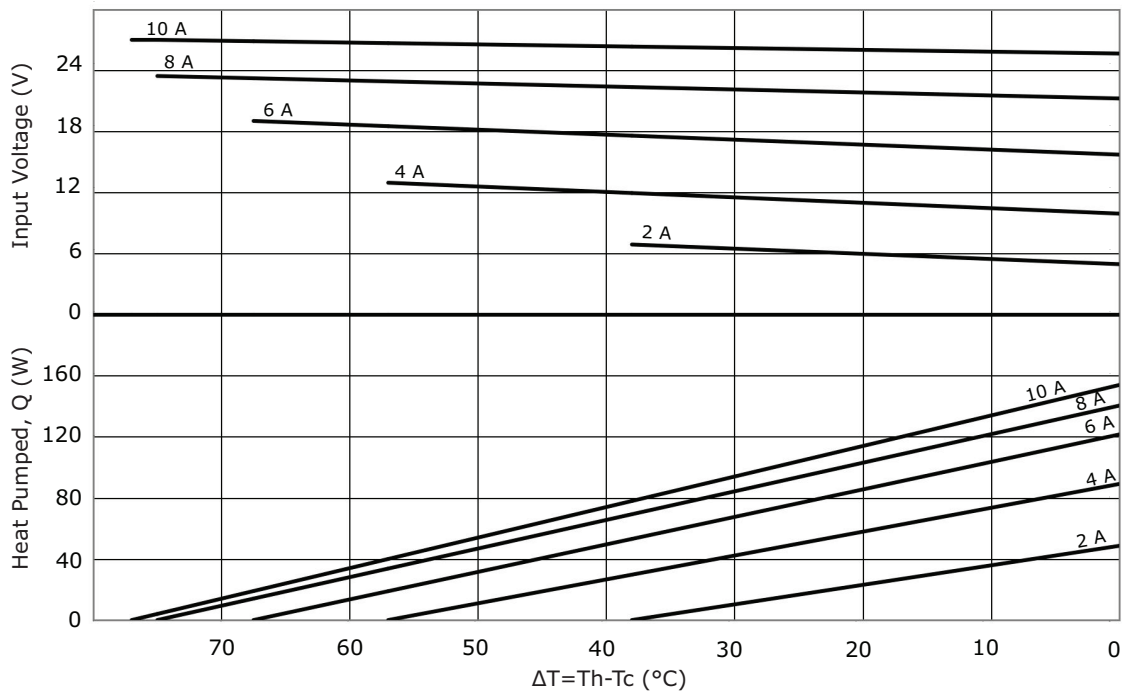

## REVISION HISTORY

rev.	description	date
1.0	initial release	11/05/2019
1.01	added models CP10205033 & CP10304033	11/09/2020
1.02	logo, datasheet style update	08/05/2022

The revision history provided is for informational purposes only and is believed to be accurate.



CUI Devices offers a one (1) year limited warranty. Complete warranty information is listed on our website.

CUI Devices reserves the right to make changes to the product at any time without notice. Information provided by CUI Devices is believed to be accurate and reliable. However, no responsibility is assumed by CUI Devices for its use, nor for any infringements of patents or other rights of third parties which may result from its use.

CUI Devices products are not authorized or warranted for use as critical components in equipment that requires an extremely high level of reliability. A critical component is any component of a life support device or system whose failure to perform can be reasonably expected to cause the failure of the life support device or system, or to affect its safety or effectiveness.

[cuidevices.com](http://cuidevices.com)