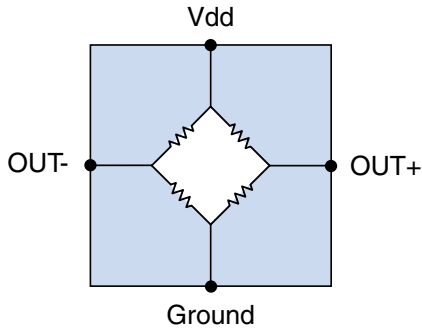


## AKT001 High-Field TMR Magnetic Sensor

### Schematic Diagram



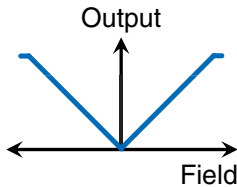
### Features

- Tunneling Magnetoresistance (TMR) technology
- 0.05 to 0.8 tesla linear range
- 1.5 tesla saturation
- High resistance for battery powered applications
- Output does not depend on field direction or polarity
- Ratiometric Wheatstone bridge outputs
- Wide supply voltage range (<1 V to 5.5 V)
- Ultraminiature 1.1 x 1.1 mm package

### Applications

- MRI magnetic fields
- Battery powered applications
- Noncontact high-current measurement
- Linear position sensing
- Harsh industrial applications

### Magnetic Response



### Description

The AKT001-14E is a high-field TMR magnetometer that provides low-power sensing of magnetic fields up to 1.5 T (15 kOe) in any direction. TMR technology generates very large signals, typically 25 mV/V at 0.5 T, for high signal-to-noise ratio measurements and high-reliability applications.

AKT001 sensors are not adversely affected by magnetic fields larger than the saturation field.

The sensor is configured as a Wheatstone bridge. The differential output is ratiometric with supply voltage and is temperature compensated.

The sensor response is both omnipolar and omnidirectional. The sensor output is unchanged by the field polarity or direction. Only the magnetic field magnitude increases the sensor output.

### Absolute Maximum Ratings

Parameter	Min.	Max.	Units
Supply voltage		7	Volts
Inverse supply voltage		-12	Volts
Storage temperature	-65	170	°C
Junction temperature	-65	170	°C
ESD <sup>1</sup>		2000	Volts
Applied magnetic field		Unlimited	

### Operating Specifications

Specifications valid overall operating voltage and temperature ranges unless otherwise noted.						
Parameter	Symbol	Min.	Typ.	Max.	Units	Test Conditions
Supply voltage	V <sub>DD</sub>	<1		5.5	Volts	
Operating temperature	T <sub>MIN</sub> ; T <sub>MAX</sub>	-40		125	°C	
Minimum detectable field <sup>2</sup>	H <sub>MIN</sub>		0.02		T	
Saturation field <sup>2</sup>	H <sub>SAT</sub>	1.5			T	
Linear range <sup>2</sup>	H <sub>LIN</sub>	0.05		0.8	T	
Non-Linearity	Lin			25	%	Unipolar
Sensitivity <sup>2</sup>	ΔV <sub>OUT</sub> /ΔH		25		mV/V/T	
Device resistance	R <sub>DEVICE</sub>	0.9	1	1.2	MΩ	T <sub>A</sub> = 25°C
Electrical offset	V <sub>O</sub>	-10		10	mV/V	
Maximum output	V <sub>OUT-MAX</sub>	35	50		mV/V	T <sub>A</sub> = 25°C
Operating frequency	f <sub>MIN</sub> ; f <sub>MAX</sub>	DC		50	kHz	
Hysteresis	H <sub>C</sub>			4	%	
Device resistance vs. temperature	TC <sub>R</sub>		-0.08		% / °C	Constant applied field
Output vs. temperature	TC <sub>V</sub> <sup>4</sup>		-0.21			Constant-voltage supply
Saturation field temperature coefficient	TC <sub>HSAT</sub> <sup>6</sup>		-0.09			

1. Human Body Model (HBM) per JESD22-A114

2. 1 tesla (T) = 10000 Gauss (G) = 10 kOe in air

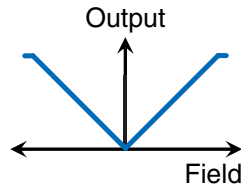
### Thermal Characteristics

Parameter	Symbol	Min.	Typ.	Max.	Units	Test Conditions
Junction-Ambient Thermal Resistance	θ <sub>JA</sub>		500		°C/W	Soldered to double-sided board
Power Dissipation	P <sub>D</sub>			100	mW	

**Operation**

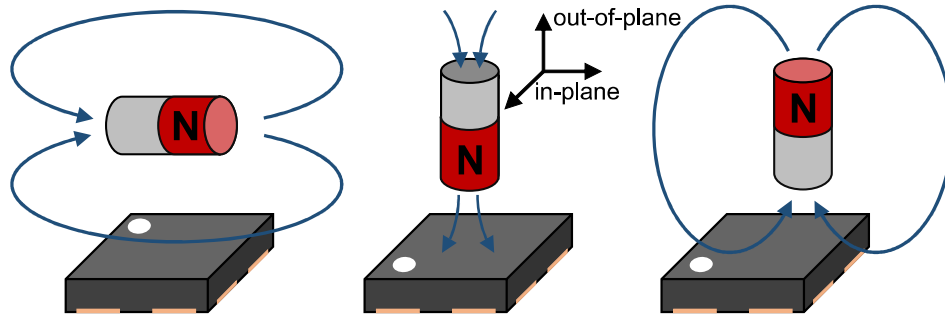
**Omnidirectional and Omnipolar Sensitivity**

The AKT001 output is proportional to the magnitude of the magnetic field in any direction. The output is “omnipolar” for fields along a single axis. This means that the output is equally sensitive to either magnetic field polarity and the differential output voltage is always positive:



**Figure 1. Omni-polar magnetic sensitivity.**

The output is also “omnidirectional.” The AKT001 sensor is sensitive to magnetic fields in any direction, so multiple sensors are not needed for orthogonal or unknown directions of applied fields, unlike single-axis sensors like Hall effect or other sensors. The diagrams in Figure 2 below show three permanent magnet orientations that will activate the sensor:



**Figure 2. Planar magnetic sensitivity.**

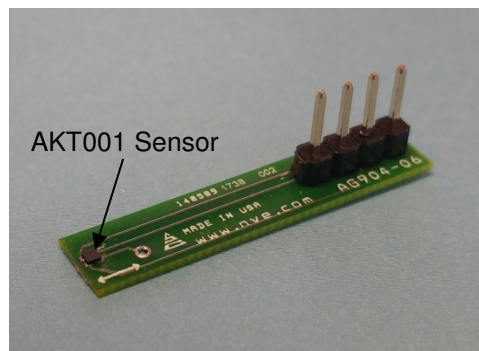
The sensitivity of the AKT001 is virtually unaffected by the angle of magnetic fields in the plane of the sensor, and increases proportional to the cosine of the angle between the applied field and the plane of the sensor package for out-of-plane magnetic fields.

**Ultra Wide Linear Range**

The AKT001 is sensitive over an incredibly wide range of magnetic fields. The minimum detectable field is 0.01 T, and the saturation field is 1.5 T for a dynamic range of 44 dB.

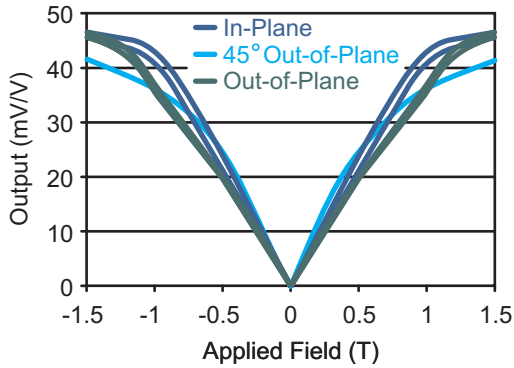
**Typical Operation**

Figure 3 shows an AKT001 sensor mounted to an available evaluation board:

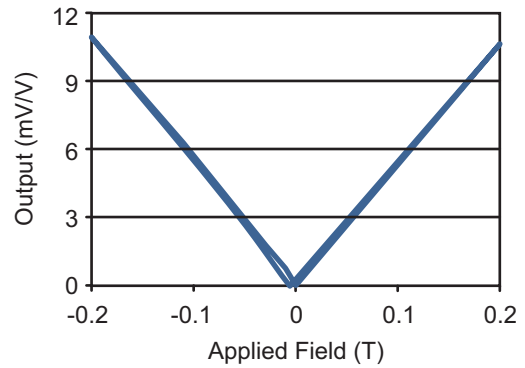


**Figure 3. AKT001-14E on an evaluation board.**

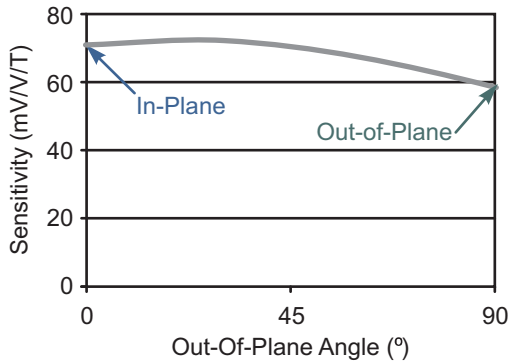
**Typical Performance Graphs**



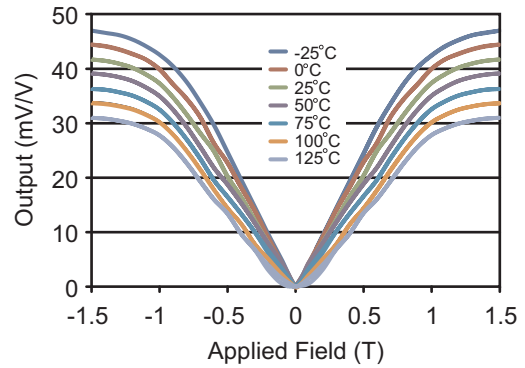
**Figure 4. Typical output, -1.5 to +1.5 T.**



**Figure 5. Typical output, -0.2 to +0.2 T (in-plane).**



**Figure 6. Sensitivity versus out-of-plane angle (0.3 T).**

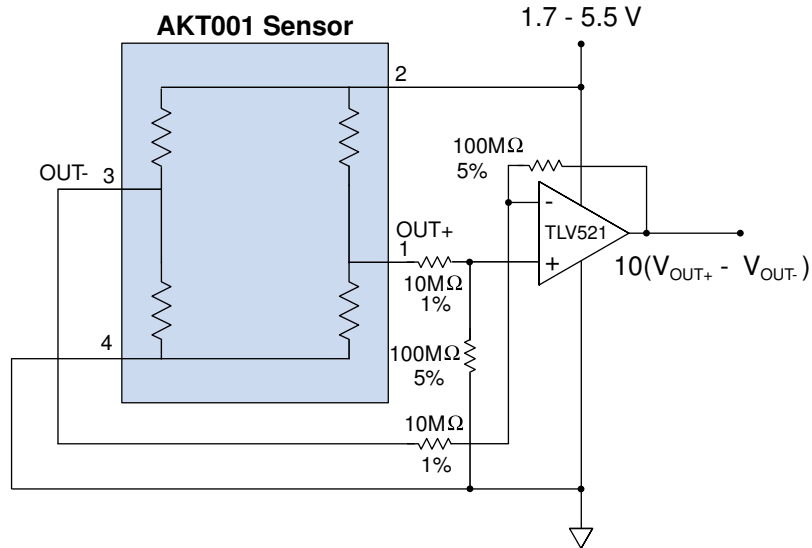


**Figure 7. Typical output at various temperatures (in-plane).**

**Typical Applications**

**Traditional Differential Amplifier**

Traditional differential amplifiers use low-cost op-amps to provide a single-ended analog output. The circuit below has a gain of 10, which provides a full-scale output at slightly less than the sensor's saturation. A low-cost, low bias-current op amp allows large resistors to avoid loading the sensor bridge.

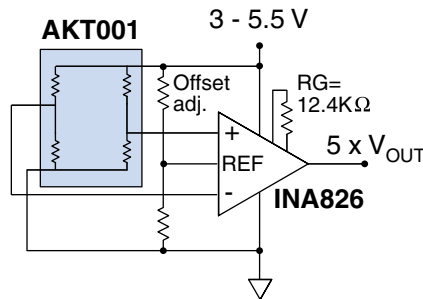


**Figure 8. Traditional op-amp differential amplifier.** A nanopower op-amp keep total power consumption low. The 10 MΩ input resistors are more than 10 times the typical sensor output impedance to minimize loading. The 100 MΩ resistors are inexpensive with a 5% tolerance. 1% resistors are relatively expensive in that resistance range, but maximize the amplifier's common mode rejection ratio.

**Sensor Instrumentation Amplifier**

Instrumentation amplifiers such as the INA826 are popular bridge sensor preamplifiers because they have a low component count, high input impedance, and high common-mode rejection ratios without needing to match resistors. These amplifiers can run on single or dual supplies.

The circuit below provides a single-ended, amplified output with offset correction:



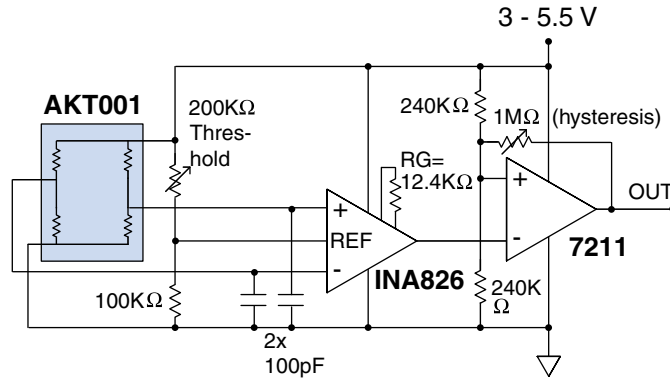
**Figure 9. Single-ended analog sensor instrumentation amplifier.**

The circuit has a gain of five, which will provide full-scale output of half the power supply with the typical maximum sensor output of 50 mV/V. The general equation for the output voltage is:

$$V_{OUT} = (1 + 49.4K / R_G)V_{IN} + V_{REF}; \quad V_{IN} = V_{OUT+} - V_{OUT-}$$

**Variable Threshold Magnetic Switch**

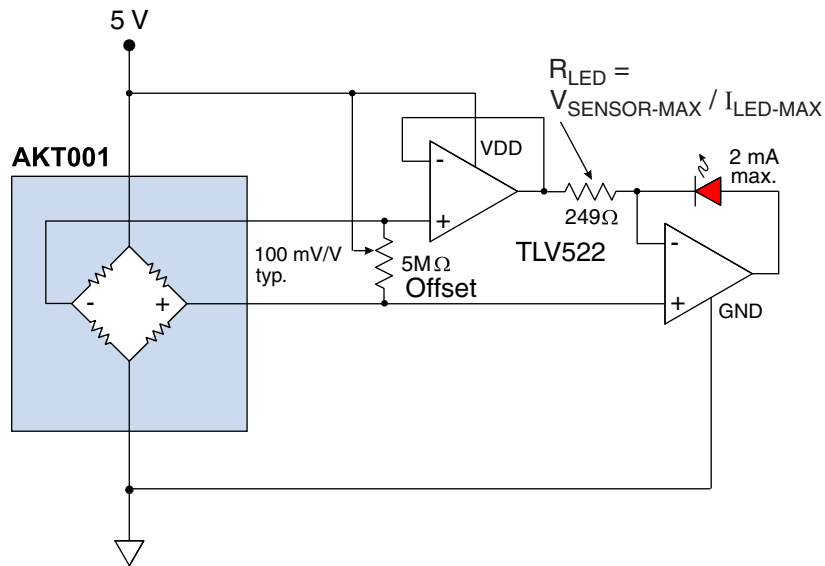
AKT001 sensors can be used as high-field magnetic switches with thresholds as high as 1.5 T and variable hysteresis, using a circuit such as this:



**Figure 10. Variable threshold magnetic switch.**

**LED Field-Strength Indicator**

The op-amp circuit in Figure 8 can be used to indicate magnetic field strength with the brightness of an LED:



**Figure 11. LED brightness changes with magnetic field.**

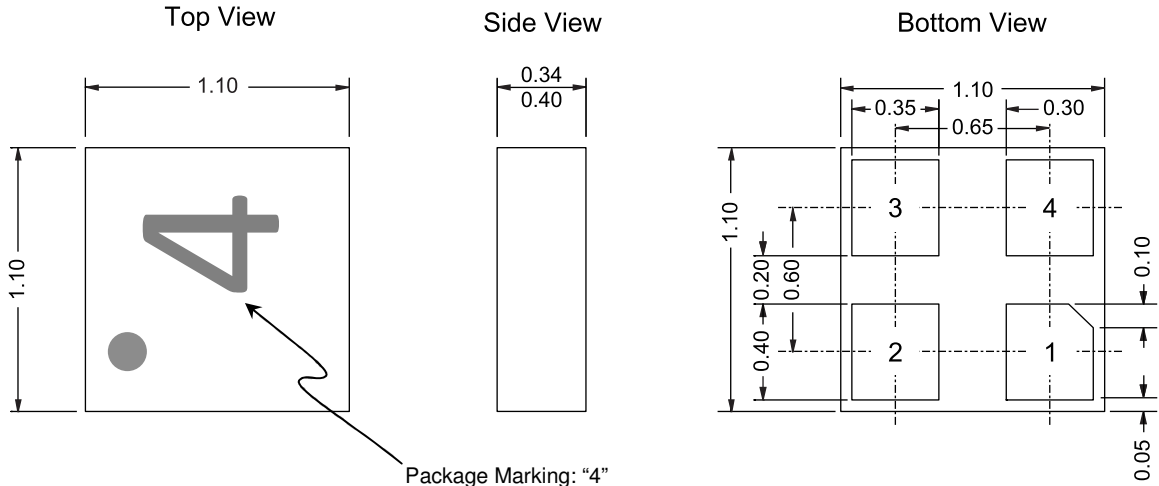
The LED current is proportional to the sensor output:

$$I_{LED} = (V_{OUT+} - V_{OUT-}) / R_{LED}$$

The maximum LED current is set to approximately 2 mA for a high-efficiency LED.

The 5 MΩ potentiometer can be used to correct for sensor offset or to set the minimum field to turn on the LED.

1.1 x 1.1 x 0.37 mm DFN4 (ULLGA) Package (-14E suffix)



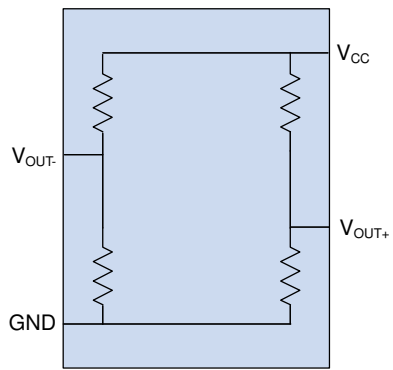
Package Marking: "4"

Dimensions in mm; ±0.10 mm unless otherwise noted.

Soldering profile per JEDEC J-STD-020C, MSL 1.



AKT001-14E Pinout and Functional Diagram:

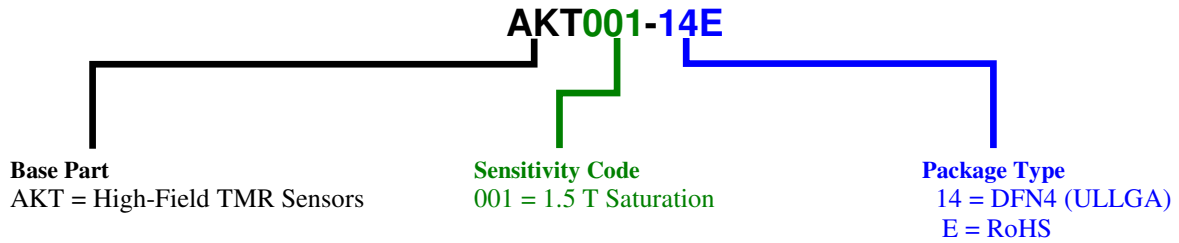


Pin	Function	Description
1	Out+	Positive bridge output (increases with field).
2	V <sub>cc</sub>	Positive bridge supply.
3	Out-	Negative bridge output (decreases with field).
4	Ground	Negative bridge supply or ground.

This product has been tested for electrostatic sensitivity to the limits stated in the specifications. However, NVE recommends that all integrated circuits be handled with appropriate care to avoid damage. Damage caused by inappropriate handling or storage could range from performance degradation to complete failure.



**Part Numbering**



**Part Marking**

Available Part	Marking
AKT001-14E	4

**Bare Circuit Board**

NVE offers a bare circuit board for easy connections to 1.1 mm DFN4 sensors. These very small sensors generally require reflow or hot-air soldering techniques:



(actual size)

**AG904-06: DFN4 PCB**

1.2 x 0.25 inch (30 x 6 mm) PCB for demonstrating 1.1 x 1.1 mm DFN4 (ULLGA) sensors (sensors with a -14E suffix).



***Revision History***

---

**SB-00-107 – Rev. B**  
June 2020

**Change**

- Dropped references to constant-current drive since there's no advantage.

**SB-00-107 – Rev. A**  
June 2020

**Changes**

- Lowered minimum linear field and TCOV for improved linearity and sensitivity over temperature.
- Initial release

**SB-00-107 - Prelim**  
August 2019

**Change**

- Preliminary Release

#### **Datasheet Limitations**

The information and data provided in datasheets shall define the specification of the product as agreed between NVE and its customer, unless NVE and customer have explicitly agreed otherwise in writing. All specifications are based on NVE test protocols. In no event however, shall an agreement be valid in which the NVE product is deemed to offer functions and qualities beyond those described in the datasheet.

#### **Limited Warranty and Liability**

Information in this document is believed to be accurate and reliable. However, NVE does not give any representations or warranties, expressed or implied, as to the accuracy or completeness of such information and shall have no liability for the consequences of use of such information.

In no event shall NVE be liable for any indirect, incidental, punitive, special or consequential damages (including, without limitation, lost profits, lost savings, business interruption, costs related to the removal or replacement of any products or rework charges) whether or not such damages are based on tort (including negligence), warranty, breach of contract or any other legal theory.

#### **Right to Make Changes**

NVE reserves the right to make changes to information published in this document including, without limitation, specifications and product descriptions at any time and without notice. This document supersedes and replaces all information supplied prior to its publication.

#### **Use in Life-Critical or Safety-Critical Applications**

Unless NVE and a customer explicitly agree otherwise in writing, NVE products are not designed, authorized or warranted to be suitable for use in life support, life-critical or safety-critical devices or equipment. NVE accepts no liability for inclusion or use of NVE products in such applications and such inclusion or use is at the customer's own risk. Should the customer use NVE products for such application whether authorized by NVE or not, the customer shall indemnify and hold NVE harmless against all claims and damages.

#### **Applications**

Applications described in this datasheet are illustrative only. NVE makes no representation or warranty that such applications will be suitable for the specified use without further testing or modification.

Customers are responsible for the design and operation of their applications and products using NVE products, and NVE accepts no liability for any assistance with applications or customer product design. It is customer's sole responsibility to determine whether the NVE product is suitable and fit for the customer's applications and products planned, as well as for the planned application and use of customer's third party customers. Customers should provide appropriate design and operating safeguards to minimize the risks associated with their applications and products.

NVE does not accept any liability related to any default, damage, costs or problem which is based on any weakness or default in the customer's applications or products, or the application or use by customer's third party customers. The customer is responsible for all necessary testing for the customer's applications and products using NVE products in order to avoid a default of the applications and the products or of the application or use by customer's third party customers. NVE accepts no liability in this respect.

#### **Limiting Values**

Stress above one or more limiting values (as defined in the Absolute Maximum Ratings System of IEC 60134) will cause permanent damage to the device. Limiting values are stress ratings only and operation of the device at these or any other conditions above those given in the recommended operating conditions of the datasheet is not warranted. Constant or repeated exposure to limiting values will permanently and irreversibly affect the quality and reliability of the device.

#### **Terms and Conditions of Sale**

In case an individual agreement is concluded only the terms and conditions of the respective agreement shall apply. NVE hereby expressly objects to applying the customer's general terms and conditions with regard to the purchase of NVE products by customer.

#### **No Offer to Sell or License**

Nothing in this document may be interpreted or construed as an offer to sell products that is open for acceptance or the grant, conveyance or implication of any license under any copyrights, patents or other industrial or intellectual property rights.

#### **Export Control**

This document as well as the items described herein may be subject to export control regulations. Export might require a prior authorization from national authorities.

#### **Automotive Qualified Products**

Unless the datasheet expressly states that a specific NVE product is automotive qualified, the product is not suitable for automotive use. It is neither qualified nor tested in accordance with automotive testing or application requirements. NVE accepts no liability for inclusion or use of non-automotive qualified products in automotive equipment or applications.

In the event that customer uses the product for design-in and use in automotive applications to automotive specifications and standards, customer (a) shall use the product without NVE's warranty of the product for such automotive applications, use and specifications, and (b) whenever customer uses the product for automotive applications beyond NVE's specifications such use shall be solely at customer's own risk, and (c) customer fully indemnifies NVE for any liability, damages or failed product claims resulting from customer design and use of the product for automotive applications beyond NVE's standard warranty and NVE's product specifications.

An ISO 9001 Certified Company

NVE Corporation  
11409 Valley View Road  
Eden Prairie, MN 55344-3617 USA  
Telephone: (952) 829-9217

[www.nve.com](http://www.nve.com)  
e-mail: [sensor-info@nve.com](mailto:sensor-info@nve.com)

©NVE Corporation  
All rights are reserved. Reproduction in whole or in part is prohibited without the prior written consent of the copyright owner.