

# MLX92251LSE-AxA

## Dual Hall Effect Latch with Speed & Direction Detection

### Features and Benefits

- Operating Voltage from 2.7V to 24V
- Two Integrated Hall plates for Direction Detection
- Latching Magnetic Characteristics
- Speed & Direction Open-Drain Outputs
- Direction Output updated prior Speed Output
- Excellent Temperature Stability
- Reverse Supply Voltage Protection
- Output Current Limitation and Auto-Shutoff
- Under-Voltage Lockout Protection

### Applications

- Windows lifter with Anti-Pinch feature
- Rotation speed & direction detection
- Linear speed & direction detection
- Angular position detection
- Power closures with Anti-Pinch features

### Ordering information

Part No.	Temperature Code	Sensitivity	Package Code	Packing Form
MLX92251LSE-AAA-000-RE	L (-40°C to 150°C)	± 7.5 mT	SE (TSOT-5L)	RE (Tape & Reel)
MLX92251LSE-ABA-000-RE	L (-40°C to 150°C)	± 2.5 mT	SE (TSOT-5L)	RE (Tape & Reel)

#### Legend:

Temperature Code: L for Temperature Range -40°C to 150°C  
Package Code: SE for TSOT,  
Packing Form: RE for Reel  
Ordering example: MLX92251LSE-AAA-000-RE

## 1. Functional Diagram

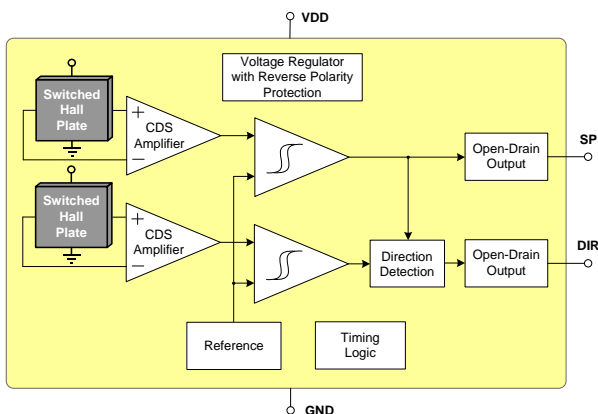

## 2. General Description

The Melexis MLX92251 is a second generation Hall-effect dual latch designed in mixed signal CMOS technology. The device integrates a voltage regulator, two Hall sensors with advanced offset cancellation system and two open-drain output drivers, all in a single package.

Two Hall plates are integrated on the same piece of silicon, thus using the high precision of the wafer fabrication process to ensure a fixed

spacing of 1.45mm between the sensing elements. The first Hall plate signal is used to provide the speed signal output. The combination of both the first and second Hall plate signals is then internally processed to directly deliver a direction signal output.

The MLX92251 shares the MLX922xx-based platform, synonym of high performance in terms of electrical specification, magnetic specification and protection level.

With latching magnetic characteristics, the speed (SP) output is turned low or high respectively with a sufficiently strong South or North pole facing the package top side. When removing the magnetic field, the device keeps its previous state.

The direction (DIR) output is latched in Low or High state depending on the movement direction of the applied magnetic field, as a result of certain magnetic pulse sequence on both Hall sensors.

The MLX92251 is delivered in a Green compliant 5-pin Thin Small Outline Transistor (TSOT) for surface-mount process.

## Contents

Features and Benefits.....	1
Applications.....	1
Ordering information .....	1
1. Functional Diagram .....	1
2. General Description.....	1
3. Glossary of Terms.....	4
4. Pin Definitions and Descriptions .....	4
5. Absolute Maximum Ratings.....	4
6. General Electrical Specifications.....	5
7. Magnetic Specifications.....	6
7.1. MLX92251LSE-AAA-000.....	6
7.2. MLX92251LSE-ABA-000.....	6
8. Output Behavior versus Magnetic Pole .....	7
9. Application Information.....	8
9.1. Default Application Schematic .....	8
9.2. Recommended Application Schematic for ISO7637-2 (pulses 5a and 5b) .....	8
9.3. Speed (SP) Output Behavior vs. $B_{OP}/B_{RP}$ .....	8
9.4. Output Jitter, Speed Signal Delay and Direction Detection.....	9
9.5. UV lockout and POR behaviour .....	9
10. Performance Graphs .....	10
10.1. Magnetic parameters vs. $T_A$ .....	10
10.2. Magnetic parameters vs. $V_{DD}$ .....	10
10.3. $V_{DSON}$ vs. $T_A$ .....	10
10.4. $V_{DSON}$ vs. $V_{DD}$ .....	10
10.5. $I_{DD}$ vs. $T_A$ .....	10
10.6. $I_{DD}$ vs. $V_{DD}$ .....	10
10.7. $I_{LEAK}$ vs. $T_A$ .....	11
10.8. $I_{LEAK}$ vs. $V_{DD}$ .....	11
10.9. Power Derating vs. $T_A$ .....	11
11. Standard information .....	12
12. ESD Precautions .....	12
13. TSOT-5L (SE) Package Information.....	13

**MLX92251LSE-AxA**

Dual Hall Effect Latch with Speed & Direction



13.1. TSOT-5L – Package dimensions..... 13

13.2. TSOT-5L – Sensitive spots..... 13

13.3. TSOT-5L – Package marking ..... 14

**14. Contact..... 15**

**15. Disclaimer..... 15**

### 3. Glossary of Terms

MilliTesla (mT), Gauss	Units of magnetic flux density: 1mT = 10 Gauss
RoHS	Restriction of Hazardous Substances
TSOT	Thin Small Outline Transistor – also referred with the Melexis package code “SE”
ESD	Electro-Static Discharge

### 4. Pin Definitions and Descriptions

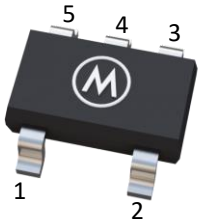

Pin #	Name	Description
1	SPEED	Open-Drain Output
2	DIRECTION	Open-Drain Output
3	VDD	Power Supply
4	GND	Ground pin
5	GND	Ground pin

Note: Both GND pins should be connected (pin 4 and pin 5)

### 5. Absolute Maximum Ratings

Parameter	Symbol	Value	Units
Supply Voltage	V <sub>DD</sub>	+27	V
Supply Current	I <sub>DD</sub>	+20	mA
Reverse Supply Voltage	V <sub>DDREV</sub>	-27	V
Reverse Supply Current	I <sub>DDREV</sub>	-20	mA
Output Voltage	V <sub>OUT</sub>	+27	V
Output Current	I <sub>OUT</sub>	+20	mA
Reverse Output Voltage	V <sub>OUTREV</sub>	-0.5	V
Reverse Output Current	I <sub>OUTREV</sub>	-50	mA
Operating Temperature Range	T <sub>A</sub>	-40 to +150	°C
Storage Temperature Range	T <sub>S</sub>	-55 to +165	°C
Maximum Junction Temperature	T <sub>J</sub>	+165	°C
ESD Sensitivity – HBM <sup>(1)</sup>	-	2500	V
ESD Sensitivity – CDM <sup>(2)</sup>	-	1000	V
Magnetic Flux Density	B	Unlimited	mT

Exceeding the absolute maximum ratings may cause permanent damage.  
 Exposure to absolute-maximum-rated conditions for extended periods may affect device reliability.

<sup>1</sup> Human Body Model according AEC-Q100-002 standard.

<sup>2</sup> Charged Device Model according AEC-Q100-011 standard.

## 6. General Electrical Specifications

DC Operating Parameters  $T_A = -40^{\circ}\text{C}$  to  $150^{\circ}\text{C}$ ,  $V_{DD} = 2.7\text{V}$  to  $24\text{V}$  (unless otherwise specified)

Parameter	Symbol	Test Conditions	Min	Typ <sup>(1)</sup>	Max	Units
Supply Voltage	$V_{DD}$	Operating	2.7	-	24	V
Supply Current	$I_{DD}$	$V_{DD} = 12\text{V}$	3	4.5	7	mA
Reverse Supply Current	$I_{DDREV}$	$V_{DD} = -18\text{V}$			1	mA
Output Leakage Current	$I_{OFF}$	$V_{OUT} = 12\text{V}$ , $V_{DD} = 12\text{V}$ , $B < B_{RP}$		0.1	10	$\mu\text{A}$
Output Saturation Voltage	$V_{OUTS}$	$B > B_{OP}$ , $I_{OUT} = 10\text{mA}$		0.2	0.5	V
Output Rise/Fall Time <sup>(2,3)</sup>	$t_R / t_F$	$V_{DD} = 12\text{V}$ , $V_{PU}^{(4)} = 5\text{V}$ , $R_{PU} = 1\text{k}\Omega$ , $C_L = 50\text{pF}$	0.1	0.3	1	$\mu\text{s}$
Output Current Limit	$I_{CL}$	$B > B_{OP}$ , $V_{OUT} = 12\text{V}$	14	25	44	mA
Output ON Time under Current Limit conditions <sup>(5)</sup>	$t_{CLON}$	$B > B_{OP}$ , $V_{PU} = 12\text{V}$ , $R_{PU} = 100\Omega$	150	230		$\mu\text{s}$
Output OFF Time under Current Limit conditions <sup>(5)</sup>	$t_{CLOFF}$	$B > B_{OP}$ , $V_{PU} = 12\text{V}$ , $R_{PU} = 100\Omega$		3.5		ms
Chopping Frequency	$f_{CHOP}$			400		kHz
Speed Signal Delay <sup>(2,6)</sup>	$t_{SPD}$		0.4	0.85	1.6	$\mu\text{s}$
Output Refresh Period	$t_{PER}$		3.2	5	8.4	$\mu\text{s}$
Output Jitter (p-p value) <sup>(2)</sup>	$t_{JITTER}$	Over 1000 successive output switching events @1kHz square wave, $B_{PEAK} = 50\text{mT}$ , $t_{RISE} = t_{FALL} \leq 100\mu\text{s}$		$\pm 2.6$		$\mu\text{s}$
Maximum Switching Frequency <sup>(2,7)</sup>	$f_{SW}$	$\geq 30\text{mT}$ square wave magnetic field	40	66		kHz
Power-On Time <sup>(8)</sup>	$t_{PON}$	$V_{DD} = 5\text{V}$ , $dV_{DD}/dt > 2\text{V}/\mu\text{s}$		16	35	$\mu\text{s}$
Under-voltage Lockout Threshold	$V_{UVL}$		2.2	2.4	2.7	V
Under-voltage Lockout Reaction time <sup>(2)</sup>	$t_{UVL}$			1		$\mu\text{s}$
SE Package Thermal Resistance	$R_{TH}$	Single layer (1S) JEDEC board		300		$^{\circ}\text{C}/\text{W}$

1 Typical values are defined at  $T_A = +25^{\circ}\text{C}$  and  $V_{DD} = 12\text{V}$

2 Based on device characterization results, not subject to production test

3 Measured between  $0.1 \cdot V_{PU}$  and  $0.9 \cdot V_{PU}$

4  $R_{PU}$  and  $V_{PU}$  are respectively the external pull-up resistor and pull-up power supply

5 If the Output is in Current Limitation longer than  $t_{CLON}$  the Output is switched off in high-impedance state. The Output returns back in active state at next reaching of  $B_{OP}$  or after  $t_{CLOFF}$  time interval

6 Controlled delay between direction (DIR) signal update and speed (SP) signal update

7 Maximum switching frequency corresponds to the max frequency of the applied magnetic field which is detected without loss of pulses

8 The Power-On Time represents the time from reaching  $V_{DD} = 2.7\text{V}$  to the first refresh of the SP output

## 7. Magnetic Specifications

### 7.1. MLX92251LSE-AAA-000

DC Operating Parameters  $V_{DD} = 2.7V$  to  $24V$  and  $T_A = -40^{\circ}C$  to  $150^{\circ}C$  (unless otherwise specified)

Parameter	Symbol	Test Conditions	Min	Typ	Max	Units
Operating Point	$B_{OP}$		5	7.5	10	mT
Release Point	$B_{RP}$		-10	-7.5	-5	mT
Magnetic Matching	$B_{MATCH}$	$B_{OP1} - B_{OP2}$ or $B_{RP1} - B_{RP2}$ , $T_A = 25^{\circ}C$	-2		2	mT
		$B_{OP1} - B_{OP2}$ or $B_{RP1} - B_{RP2}$	-3		3	mT
Magnetic Offset	$B_{OFF}$	$(B_{OP1} + B_{RP1}) / 2$ , $(B_{OP2} + B_{RP2}) / 2$	-2		2	mT
Temperature Coefficient	TC			0		ppm/ $^{\circ}C$
Hall Plates Spacing	-			1.45		mm

### 7.2. MLX92251LSE-ABA-000

DC Operating Parameters  $V_{DD} = 2.7V$  to  $24V$  and  $T_A = -40^{\circ}C$  to  $150^{\circ}C$  (unless otherwise specified)

Parameter	Symbol	Test Conditions	Min	Typ	Max	Units
Operating Point	$B_{OP}$		0.6	2.5	4.5	mT
Release Point	$B_{RP}$		-4.5	-2.5	-0.6	mT
Magnetic Matching	$B_{MATCH}$	$B_{OP1} - B_{OP2}$ or $B_{RP1} - B_{RP2}$ , $T_A = 25^{\circ}C$	-2		2	mT
		$B_{OP1} - B_{OP2}$ or $B_{RP1} - B_{RP2}$	-3		3	mT
Magnetic Offset	$B_{OFF}$	$(B_{OP1} + B_{RP1}) / 2$ , $(B_{OP2} + B_{RP2}) / 2$	-2		2	mT
Temperature Coefficient	TC			-1100		ppm/ $^{\circ}C$
Hall Plates Spacing	-			1.45		mm

**Note:** Temperature coefficient value is guaranteed by design and verified by characterization and is calculated using the following formula:

$$TC = \frac{B_{T2} - B_{T1}}{B_{25^{\circ}C} \times (T_2 - T_1)} * 10^6, ppm/^{\circ}C; T_1 = -40^{\circ}C; T_2 = 150^{\circ}C$$

## 8. Output Behavior versus Magnetic Pole

DC Operating Parameters  $T_A = -40^{\circ}\text{C}$  to  $150^{\circ}\text{C}$ ,  $V_{DD} = 2.7\text{V}$  to  $24\text{V}$  (unless otherwise specified)

Parameter	Test Conditions	SP Output State
South pole	$B > B_{OP}$	Low
North pole	$B < B_{RP}$	High <sup>(1)</sup>

Output behavior versus magnetic pole <sup>(2)</sup>

Direction	Step	H1	H2	DIR Output State
<b>CCW</b>	$n_x$	N	S	<b>Low</b>
	$n_{(x+1)}$	N	N	
	$n_{(x+2)}$	S	N	
	$n_{(x+3)}$	S	S	
	$n_{(x+4)} \equiv n_x$	N	S	

Direction	Step	H1	H2	DIR Output State
<b>CW</b>	$n_x$	N	S	<b>High <sup>(3)</sup></b>
	$n_{(x+1)}$	S	S	
	$n_{(x+2)}$	S	N	
	$n_{(x+3)}$	N	N	
	$n_{(x+4)} \equiv n_x$	N	S	

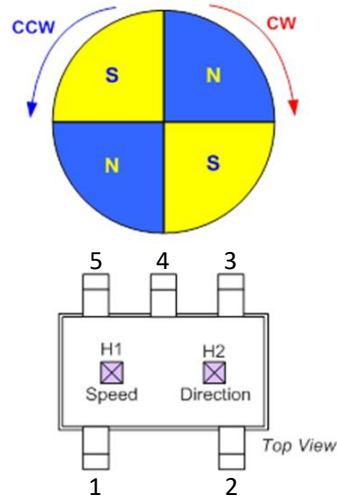

<sup>1</sup> Default SP output state during power-up

<sup>2</sup> Magnetic pole applied perpendicularly to Hall plate "H1", facing the branded/top side of the package

<sup>3</sup> Default magnetic and DIR output state during power-up

## 9. Application Information

### 9.1. Default Application Schematic

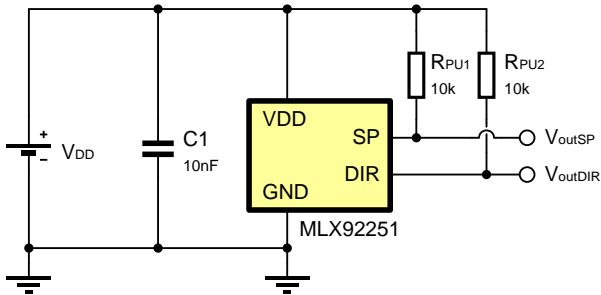

### 9.2. Recommended Application Schematic for ISO7637-2 (pulses 5a and 5b)

Notes:

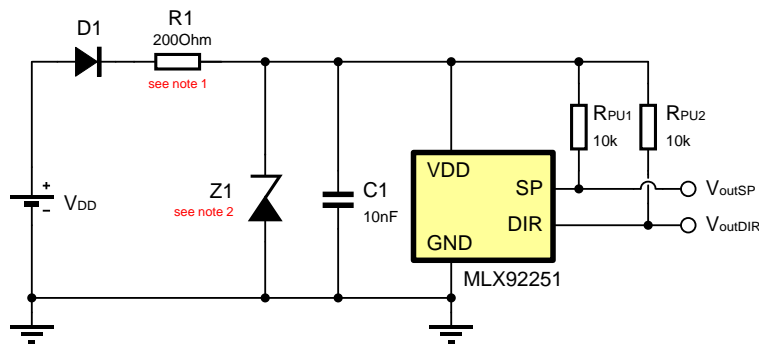

1. Recommended for conducted transients on supply line above 32V with duration above 500ms.
2. Recommended for conducted transients on supply line above 36V.
3. Recommended zener diode Z1 is BZX55C27 or equivalent.

### 9.3. Speed (SP) Output Behavior vs. $B_{OP}/B_{RP}$

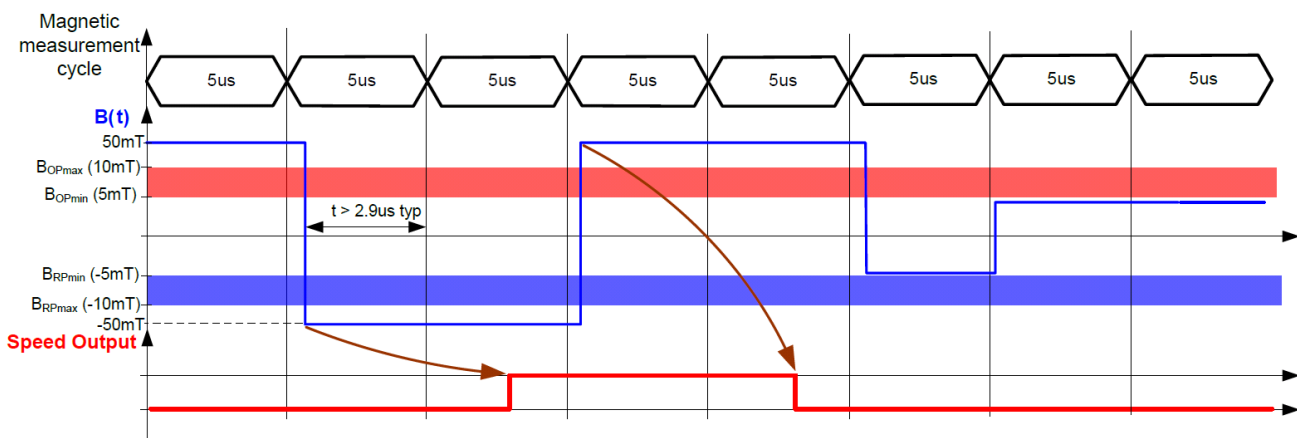

Note: The decision for output update is taken at the end of each magnetic measurement cycle



### 9.4. Output Jitter, Speed Signal Delay and Direction Detection

#### Output Jitter

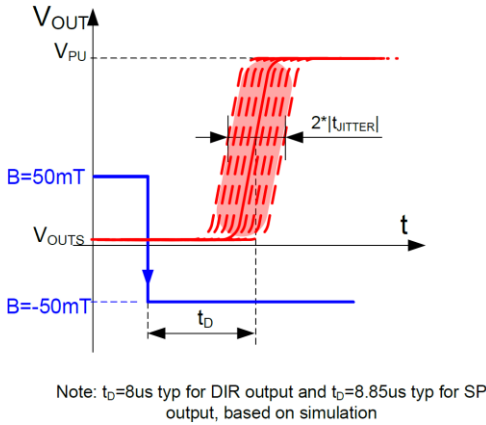

#### Direction Detection

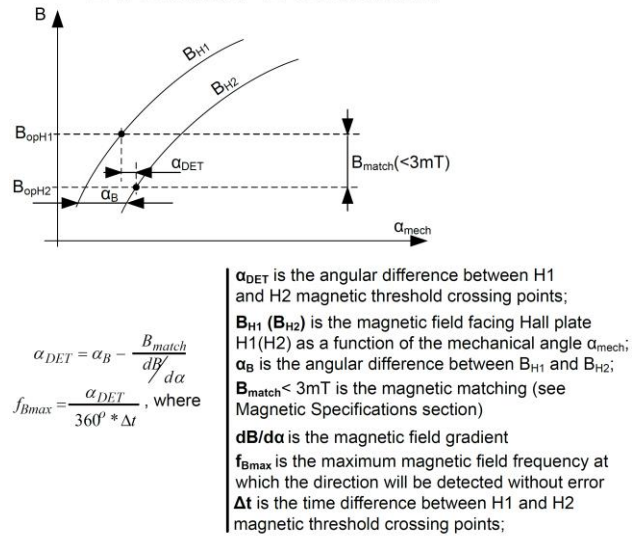

#### Speed Signal Delay

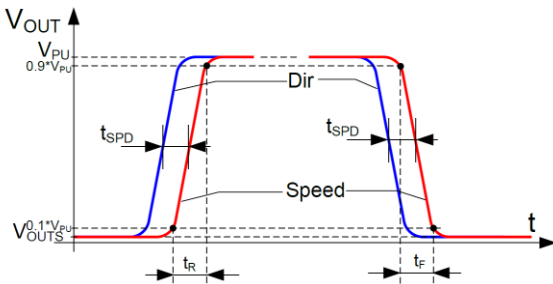

For example, if  $\alpha_B = 5^\circ$  and  $dB/d\alpha > 1mT^\circ$ ;  
 for MLX92251  $\Delta t = 10\mu s$  (definitely  $> 2 * |t_{JITTER}|$ ) could be assumed;  
 The calculated  $f_{Bmax} = 555Hz$ .

### 9.5. UV lockout and POR behaviour

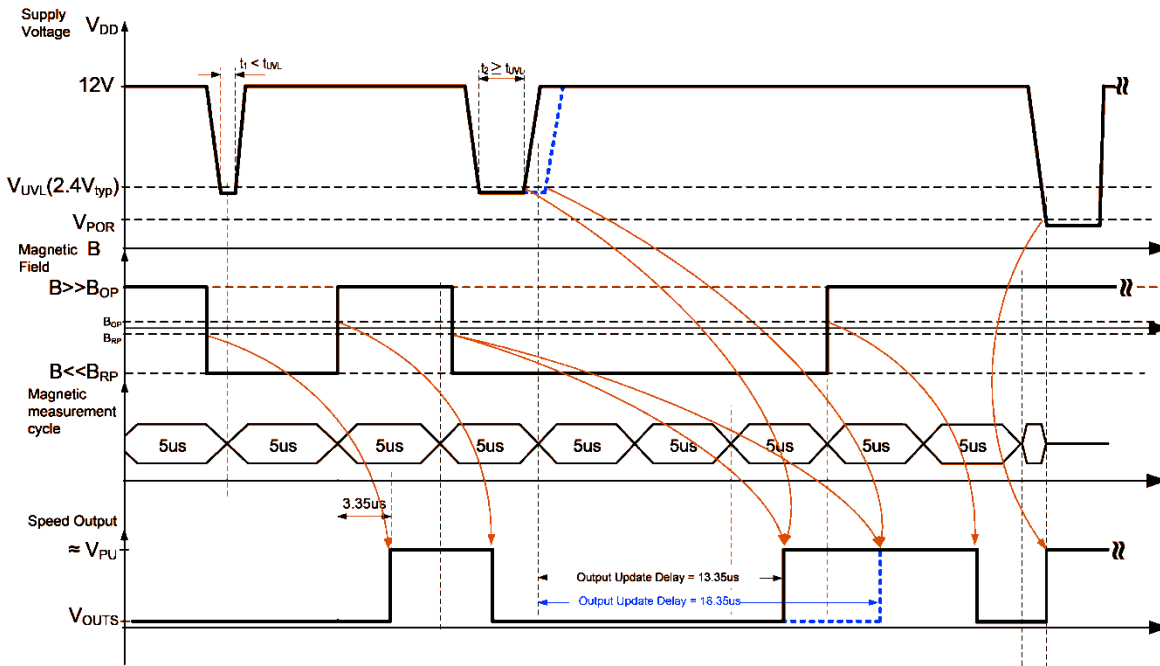

NOTE: Start-up behaviour feature does not occur after under-voltage lockout.  $V_{POR} \leq 2V$  (based on device characterization results).

## 10. Performance Graphs

### 10.1. Magnetic parameters vs. $T_A$

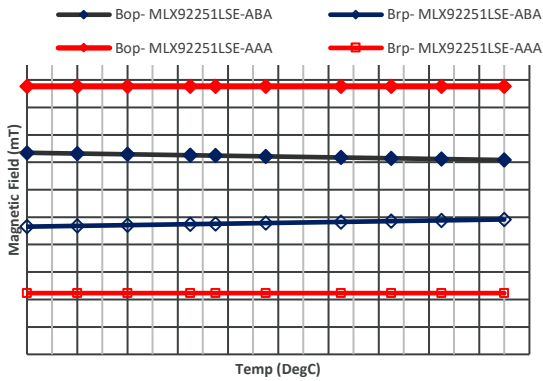

### 10.2. Magnetic parameters vs. $V_{DD}$

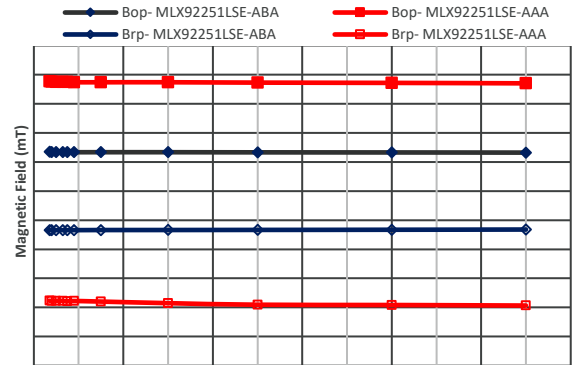

### 10.3. $V_{DSON}$ vs. $T_A$

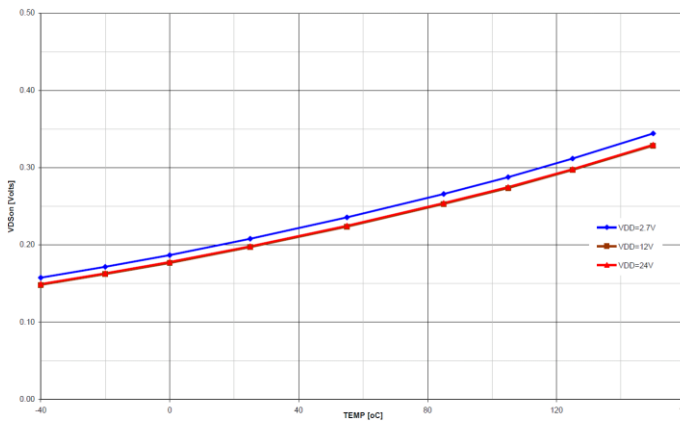

### 10.4. $V_{DSON}$ vs. $V_{DD}$

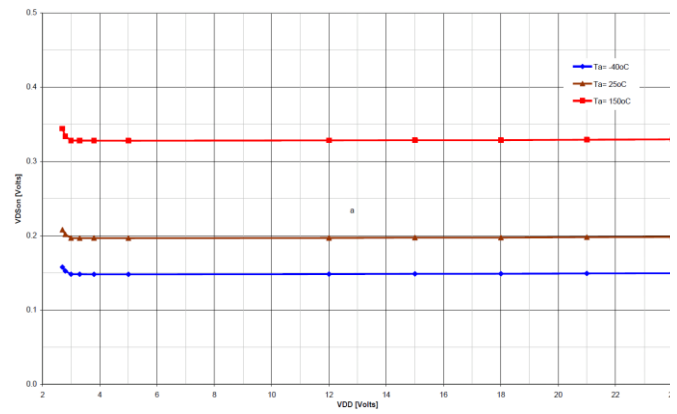

### 10.5. $I_{DD}$ vs. $T_A$

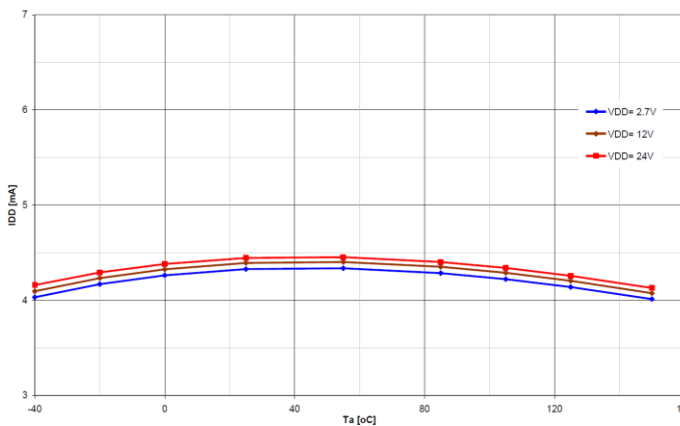

### 10.6. $I_{DD}$ vs. $V_{DD}$

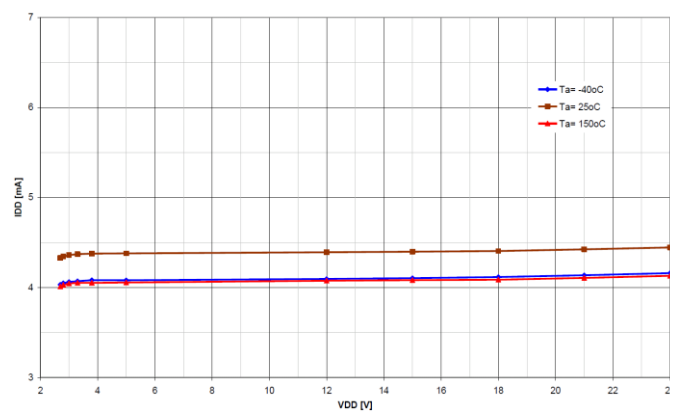

### 10.7. $I_{LEAK}$ VS. $T_A$

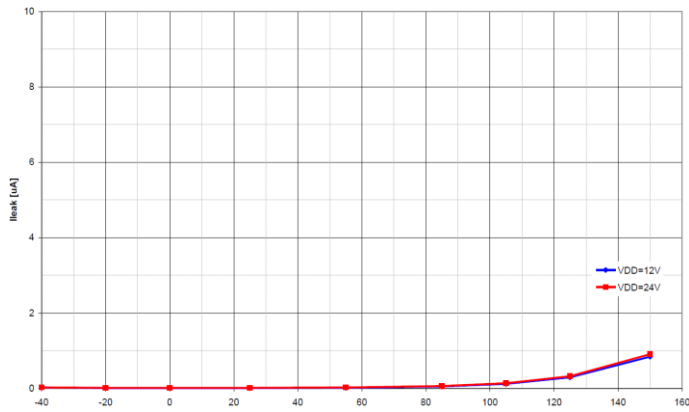

### 10.8. $I_{LEAK}$ VS. $V_{DD}$

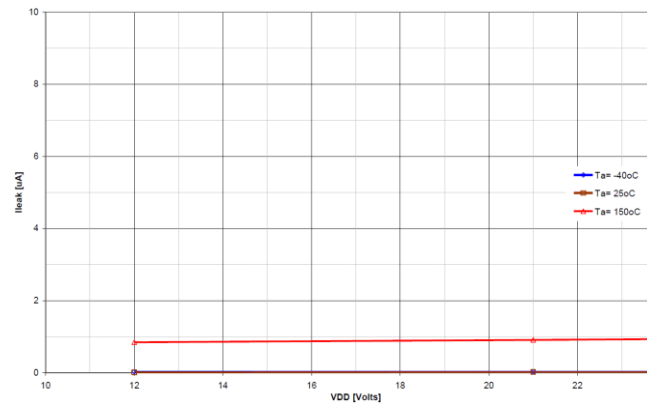

### 10.9. Power Derating vs. $T_A$

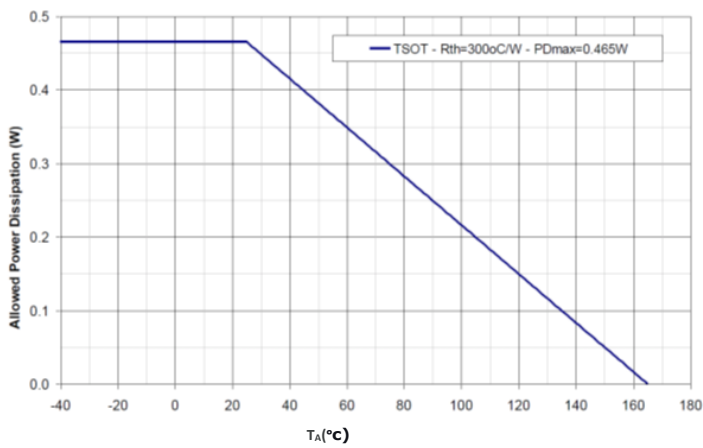

## 11. Standard information

Our products are classified and qualified regarding soldering technology, solderability and moisture sensitivity level according to following test methods:

### Reflow Soldering SMD's (Surface Mount Devices)

- IPC/JEDEC J-STD-020  
Moisture/Reflow Sensitivity Classification for Nonhermetic Solid State Surface Mount Devices (classification reflow profiles according to table 5-2)
- EIA/JEDEC JESD22-A113  
Preconditioning of Nonhermetic Surface Mount Devices Prior to Reliability Testing (reflow profiles according to table 2)

### Wave Soldering SMD's (Surface Mount Devices) and THD's (Through Hole Devices)

- EN60749-20  
Resistance of plastic- encapsulated SMD's to combined effect of moisture and soldering heat
- EIA/JEDEC JESD22-B106 and EN60749-15  
Resistance to soldering temperature for through-hole mounted devices

### Iron Soldering THD's (Through Hole Devices)

- EN60749-15  
Resistance to soldering temperature for through-hole mounted devices

### Solderability SMD's (Surface Mount Devices) and THD's (Through Hole Devices)

- EIA/JEDEC JESD22-B102 and EN60749-21  
Solderability

For all soldering technologies deviating from above mentioned standard conditions (regarding peak temperature, temperature gradient, temperature profile etc) additional classification and qualification tests have to be agreed upon with Melexis.

The application of Wave Soldering for SMD's is allowed only after consulting Melexis regarding assurance of adhesive strength between device and board.

Melexis recommends reviewing on our web site the General Guidelines [soldering recommendation](http://www.melexis.com/Quality_soldering.aspx) ([http://www.melexis.com/Quality\\_soldering.aspx](http://www.melexis.com/Quality_soldering.aspx)) as well as [trim&form recommendations](http://www.melexis.com/Assets/Trim-and-form-recommendations-5565.aspx) (<http://www.melexis.com/Assets/Trim-and-form-recommendations-5565.aspx>).

Melexis is contributing to global environmental conservation by promoting **lead free** solutions. For more information on qualifications of **RoHS** compliant products (RoHS = European directive on the Restriction Of the use of certain Hazardous Substances) please visit the quality page on our website: <http://www.melexis.com/quality.aspx>

## 12. ESD Precautions

Electronic semiconductor products are sensitive to Electro Static Discharge (ESD). Always observe Electro Static Discharge control procedures whenever handling semiconductor products.

## 13. TSOT-5L (SE) Package Information

### 13.1. TSOT-5L – Package dimensions

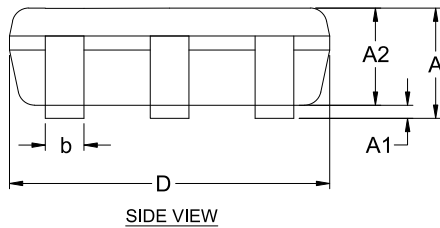
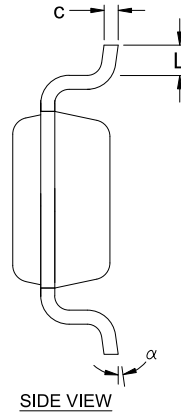
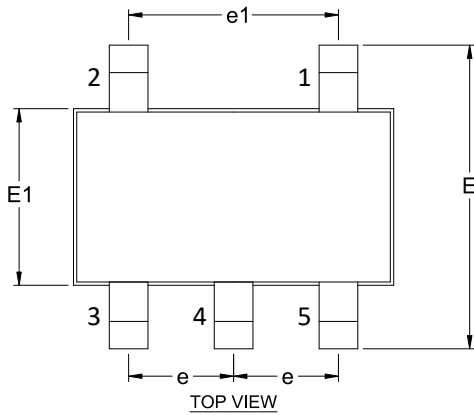

SYMBOL	MINIMUM	MAXIMUM
A	---	1.00
A1	0.025	0.10
A2	0.85	0.90
D	2.80	3.00
E	2.60	3.00
E1	1.50	1.70
L	0.30	0.50
b	0.30	0.45
c	0.10	0.20
e	0.95 BSC	
e1	1.90 BSC	
α	0°	8°

NOTE :

1. ALL DIMENSIONS IN MILLIMETERS (mm) UNLESS OTHERWISE STATED.
2. DIMENSION D DOES NOT INCLUDE MOLD FLASH OR PROTRUSIONS OF MAX 0.15 mm PER SIDE.
3. DIMENSION E DOES NOT INCLUDE MOLD FLASH OR PROTRUSIONS OF MAX 0.25 mm PER SIDE.
4. DIMENSION b DOES NOT INCLUDE DAMBAR PROTRUSION OF MAX 0.07 mm.
5. DIMENSION L IS THE LENGTH OF THE TERMINAL FOR SOLDERING TO A SUBSTRATE.
6. FORMED LEAD SHALL BE PLANAR WITH RESPECT TO ONE ANOTHER WITH 0.076 mm SEATING PLANE.

### 13.2. TSOT-5L – Sensitive spots

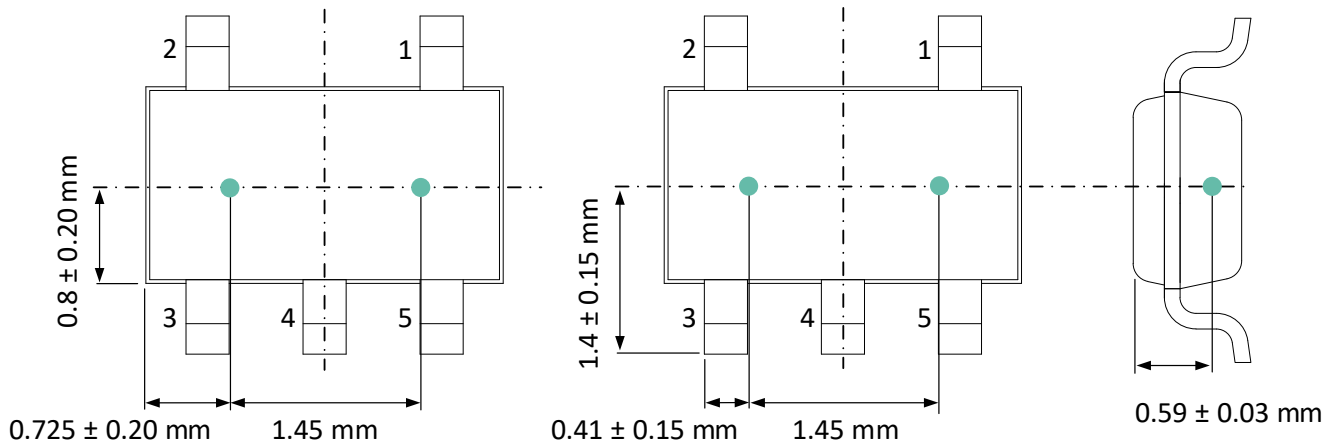

### 13.3. TSOT-5L – Package marking

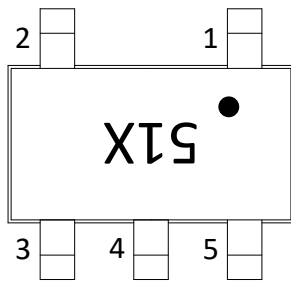

#### Top

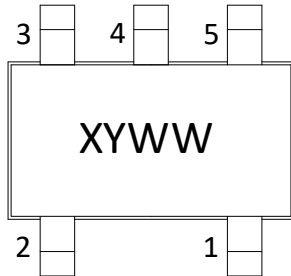
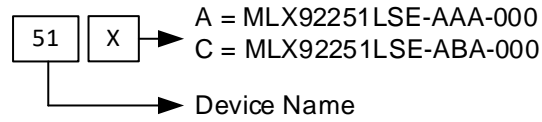

#### Bottom

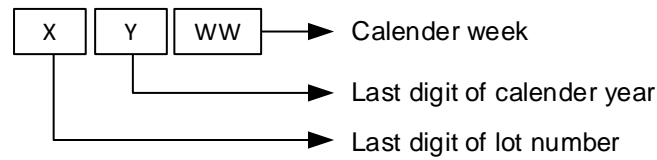

## 14. Contact

For the latest version of this document, go to our website at [www.melexis.com](http://www.melexis.com).

For additional information, get in touch via [www.melexis.com/contact](http://www.melexis.com/contact).

## 15. Disclaimer

*The content of this document is believed to be correct and accurate. However, the content of this document is furnished "as is" for informational use only and no representation, nor warranty is provided by Melexis about its accuracy, nor about the results of its implementation. Melexis assumes no responsibility or liability for any errors or inaccuracies that may appear in this document. Customer will follow the practices contained in this document under its sole responsibility. This documentation is in fact provided without warranty, term, or condition of any kind, either implied or expressed, including but not limited to warranties of merchantability, satisfactory quality, non-infringement, and fitness for purpose. Melexis, its employees and agents and its affiliates' and their employees and agents will not be responsible for any loss, however arising, from the use of, or reliance on this document. Notwithstanding the foregoing, contractual obligations expressly undertaken in writing by Melexis prevail over this disclaimer.*

*This document is subject to change without notice, and should not be construed as a commitment by Melexis. Therefore, before placing orders or prior to designing the product into a system, users or any third party should obtain the latest version of the relevant information.*

*Users or any third party must determine the suitability of the product described in this document for its application, including the level of reliability required and determine whether it is fit for a particular purpose.*

*This document as well as the product here described may be subject to export control regulations. Be aware that export might require a prior authorization from competent authorities. The product is not designed, authorized or warranted to be suitable in applications requiring extended temperature range and/or unusual environmental requirements. High reliability applications, such as medical life-support or life-sustaining equipment or avionics application are specifically excluded by Melexis. The product may not be used for the following applications subject to export control regulations: the development, production, processing, operation, maintenance, storage, recognition or proliferation of:*

- 1. chemical, biological or nuclear weapons, or for the development, production, maintenance or storage of missiles for such weapons;*
- 2. civil firearms, including spare parts or ammunition for such arms;*
- 3. defense related products, or other material for military use or for law enforcement;*
- 4. any applications that, alone or in combination with other goods, substances or organisms could cause serious harm to persons or goods and that can be used as a means of violence in an armed conflict or any similar violent situation.*

*No license nor any other right or interest is granted to any of Melexis' or third party's intellectual property rights.*

*If this document is marked "restricted" or with similar words, or if in any case the content of this document is to be reasonably understood as being confidential, the recipient of this document shall not communicate, nor disclose to any third party, any part of the document without Melexis' express written consent. The recipient shall take all necessary measures to apply and preserve the confidential character of the document. In particular, the recipient shall (i) hold document in confidence with at least the same degree of care by which it maintains the confidentiality of its own proprietary and confidential information, but no less than reasonable care; (ii) restrict the disclosure of the document solely to its employees for the purpose for which this document was received, on a strictly need to know basis and providing that such persons to whom the document is disclosed are bound by confidentiality terms substantially similar to those in this disclaimer; (iii) use the document only in connection with the purpose for which this document was received, and reproduce document only to the extent necessary for such purposes; (iv) not use the document for commercial purposes or to the detriment of Melexis or its customers. The confidentiality obligations set forth in this disclaimer will have indefinite duration and in any case they will be effective for no less than 10 years from the receipt of this document.*

*This disclaimer will be governed by and construed in accordance with Belgian law and any disputes relating to this disclaimer will be subject to the exclusive jurisdiction of the courts of Brussels, Belgium.*

*The invalidity or ineffectiveness of any of the provisions of this disclaimer does not affect the validity or effectiveness of the other provisions. The previous versions of this document are repealed.*

*Melexis © - No part of this document may be reproduced without the prior written consent of Melexis. (2022)*

IATF 16949 and ISO 14001 Certified