

DRAWING NO. ABT-0718215
 3rd ANGLE PROJECTION

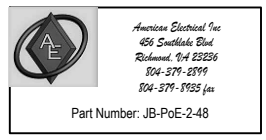
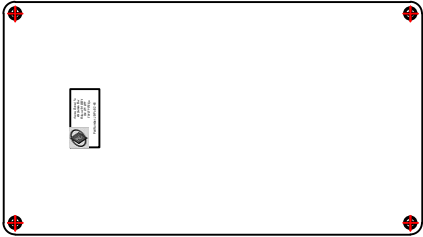
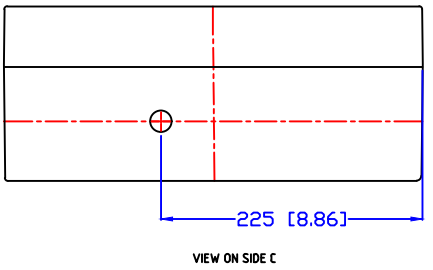
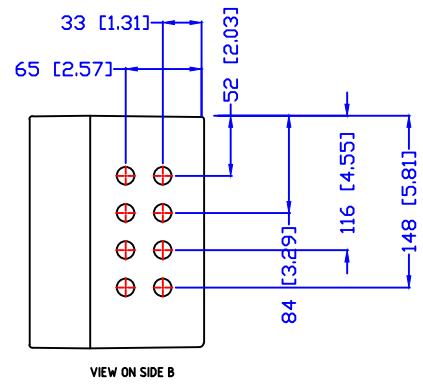
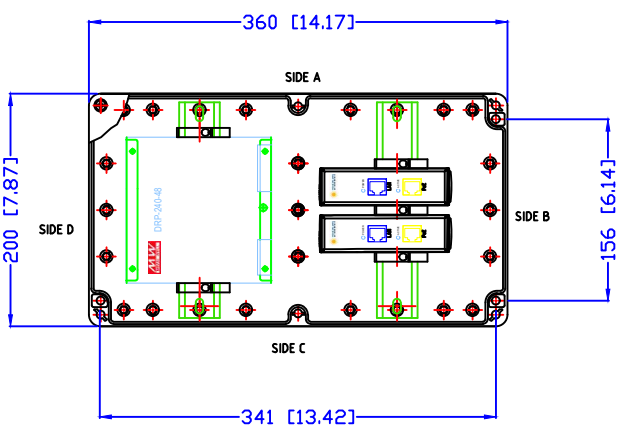
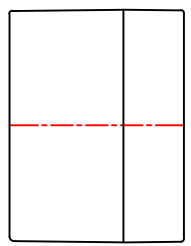
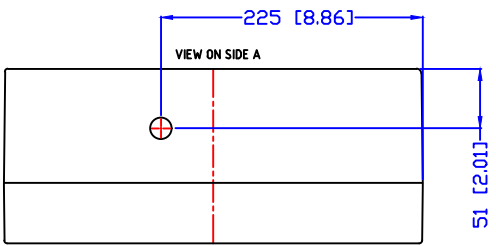

NOTES:
 CLIENT ITEM No: JB-PoE-2-48
 BOX TYPE: ZPT-18PC
 MATERIAL: POLYCARBONATE
 FINISH: RAL 7035
 RATING: NEMA 4X
 TERMINALS: XX
 XX
 5 x KD-3 495040 American Electrical to provide
 XX
 DIN RAIL: 2 x MR35 500601 American Electrical to provide
 ENTRIES & SIZES:
 SIDE A 1 x pg11 thru (18.60mm)
 SIDE B 8 x pg9 thru (15.20mm)
 SIDE C 1 x pg11 thru (18.60mm)
 SIDE D NONE
 MEANWELL: 1 x DRP-240-48 American Electrical to provide
 SOLIS ENERGY: 2 x PoE-48 American Electrical to provide
 CLIENT LABEL: AE-PoE248

Client	:AMERICAN ELECTRICAL INC
SO Number	:XX
Order No	:XX
Item Nos	:XX

					x	x				
					x	x				
					x	x				
					A		AS ISSUED			
					REV	DATE	REVISION	BY	CHK	
							CHECKED:		DATE:	
					SCALE	N.T.S.	DRAWN: GLA		DATE: 10-10-2018	

ABTECH
www.abtech-inc.com
 A.B. Controls & Technology, Inc
 1813 Rotary Drive
 Humble TX 77338
 Tel: 281-548-3424
 email: sales@abtech-inc.com

Copyright © 2018
 All rights reserved ABTECH

TITLE JB-PoE-2-48
 SHEET 1

THE INFORMATION ON THIS DRAWING IS CONFIDENTIAL AND MUST NOT BE DISCLOSED TO A THIRD PARTY WITHOUT WRITTEN CONSENT

DRAWING NO. ABT-0718215

UNLESS OTHERWISE STATED ALL DIMENSIONS ARE IN MILLIMETRES & INCHES

drawn on CAD.....DO NOT MODIFY BY HAND!!!

Refer to drawings database for certificate schedule drawings