



Reset Circuit with Manual Reset

Description

The EM6325 is an ultra-low current reset circuit available in a large variety of configurations and very small packages for maximum flexibility in all end-applications up to 125°C and using power supplies between 1.5V and 5.5V.

This circuit monitors the supply voltage of any electronic system, and generates the appropriate reset signal after a fixed reset timeout period. The threshold defines the minimum allowed voltage which guarantees the good functionality of the system. When V_{DD} rises above V_{TH} , the output remains active for an additional delay time. This allows the system to stabilize before getting fully active.

This circuit features a Manual Reset: an input that asserts reset when pulled low (\overline{MR} with internal pull-up).

Small SOT23-5L package as well as ultra-low supply current of 2.9µA make the EM6325 an ideal choice for portable and battery-operated devices.

Typical Application

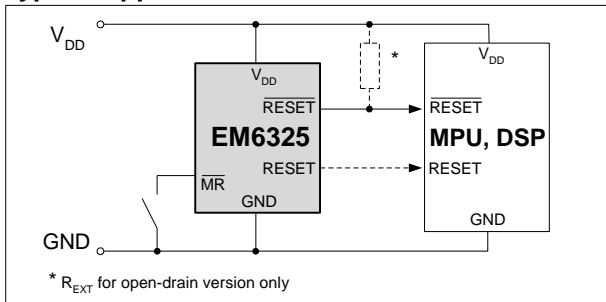

Block Diagram

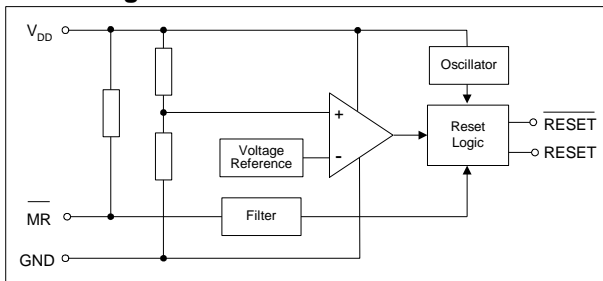

Features

- ❑ Manual reset function
- ❑ 200ms reset timeout period (1.6ms, 25ms, 1600ms on request)
- ❑ Ultra-low supply current of 2.9µA ($V_{DD}=3.3V$)
- ❑ Operating temperature range: -40°C to +125°C
- ❑ ±1.5% reset threshold accuracy
- ❑ 11 reset threshold voltages V_{TH} : 4.63V, 4.4V, 3.08V, 2.93V, 2.63V, 2.2V, 1.8V, 1.66V, 1.57V, 1.38V, 1.31V
- ❑ 2 reset output options:
 - Active-low \overline{RESET} push-pull
 - Active-low \overline{RESET} open-drain
- ❑ Immune to short negative V_{DD} transients
- ❑ Guaranteed Reset valid down to 0.9V
- ❑ Threshold hysteresis: 2.1% of V_{TH}
- ❑ Very small SOT23-5L, SOT143-4L

Applications

- ❑ Computers
- ❑ Servers and workstations
- ❑ Modems
- ❑ Wireless communication
- ❑ Metering
- ❑ Playstations
- ❑ PDA, Webpad

Pin Configuration (top view)

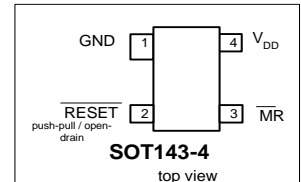
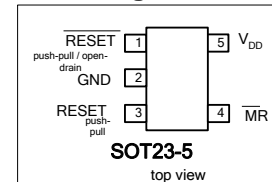

Pin Description

| Pin | | Name | Function |
|----------|-----------|--------------------|---|
| SOT23-5L | SOT143-4L | | |
| 1 | 2 | \overline{RESET} | Active-low \overline{RESET} output. \overline{RESET} remains low for the reset timeout period and then goes high after all reset conditions are deasserted or after \overline{MR} goes from low to high |
| 2 | 1 | GND | Ground |
| 3 | | RESET | Active-high RESET output. RESET remains high for the reset timeout period and then goes low after all reset conditions are deasserted or after \overline{MR} goes from low to high |
| 4 | 3 | \overline{MR} | Manual Reset input with an internal pull-up 15kΩ resistor. Reset remains active as long as \overline{MR} is low and for t_{POR} after \overline{MR} returns high. \overline{MR} can be driven with a CMOS output or shorted to ground with a switch |
| 5 | 4 | V_{DD} | Supply Voltage (5.5V max.) |



Ordering Information

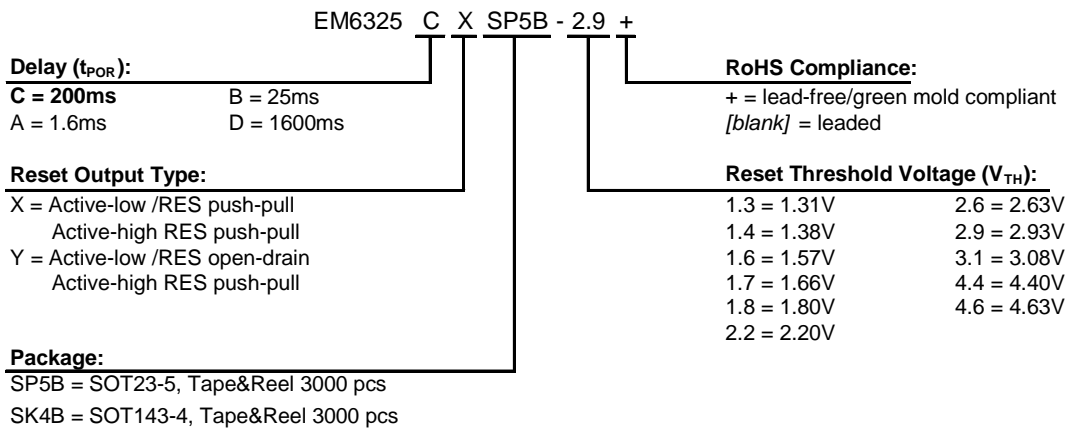

Standard Versions (Top Marking)

| Part Number | Top Marking ¹⁾ | Top Marking ²⁾ with 4 Characters |
|-------------------|---------------------------|---|
| EM6325AXSP5B-2.9+ | CN## | BNAH |
| EM6325CXSP5B-1.3+ | CP## | BNCA |
| EM6325CXSP5B-2.6+ | CS## | BNCG |
| EM6325CXSP5B-2.9+ | BZ## | BNCH |
| EM6325CXSP5B-3.1+ | CT## | BNCJ |
| EM6325CXSP5B-4.6+ | C3## | BNCL |
| EM6325CYSP5B-2.9+ | BY## | BNCU |
| EM6325CYSP5B-4.6+ | C0## | BNCX |
| EM6325CXSK4B-2.9+ | CR## | |

- 1) Top marking is the standard from 2006. No bottom marking exists. Where ## refers to the lot number (EM internal reference only)
- 2) Top marking with 4 characters is standard from 2003. For lead-free/green mold (RoHS) parts, the first letter of top marking with 4 characters begins with letter "B" instead of letter "A". Bottom marking indicates the lot number.

Standard Versions (samples)

| Part Number |
|-------------------|
| EM6325AXSP5B-2.9+ |
| EM6325CXSP5B-1.3+ |
| EM6325CXSK4B-2.9+ |
| EM6325CXSP5B-2.6+ |
| EM6325CXSP5B-2.9+ |

| Part Number |
|-------------------|
| EM6325CXSP5B-3.1+ |
| EM6325CXSP5B-4.6+ |
| EM6325CYSP5B-2.6+ |
| EM6325CYSP5B-4.6+ |

Sample stock is generally held on **standard versions** only. Please contact factory for other versions not shown here and for availability of non standard versions.



Absolute Maximum Ratings

| Parameter | Symbol | Conditions |
|---|------------------|------------------------|
| Voltage at V _{DD} to GND | V _{DD} | -0.3V to +6V |
| Minimum voltage at any signal pin | V _{MIN} | GND - 0.3V |
| Maximum voltage at any signal pin | V _{MAX} | V _{DD} + 0.3V |
| Electrostatic discharge max. to MIL-STD-883C method 3015.7 with ref. to V _{SS} | V _{ESD} | 2000V |
| Max. soldering conditions | T _{MAX} | 250°C x 10s |
| Storage Temperature Range | T _{STG} | -65°C to +150°C |

Stresses above these listed maximum ratings may cause permanent damages to the device. Exposure beyond specified operating conditions may affect device reliability or cause malfunction.

Handling Procedures

This device has built-in protection against high static voltages or electric fields; however, anti-static precautions must be taken as for any other CMOS component. Unless otherwise specified, proper operation can only occur when all terminal voltages are kept within the voltage range. Unused inputs must always be tied to a defined logic voltage level.

Operating Conditions

| Parameter | Symbol | Min | Max | Unit |
|-----------------------|-----------------|-----|------|------|
| Supply voltage | V _{DD} | 0.9 | 5.5 | V |
| Operating Temperature | T _A | -40 | +125 | °C |

Electrical Characteristics

Unless otherwise specified: V_{DD}= 0.9V to 5.5V, T_A=-40°C to +125°C (note 1).

| Parameter | Symbol | Conditions | Min | Typ | Max | Unit | | | |
|----------------------------|-----------------|-----------------------|------------------|-----------------------|------|----------------------|----|---|---|
| Supply current (note 2) | I _{DD} | V _{DD} =1.5V | +25°C | - | 2.3 | 4.6 | µA | | |
| | | | -40°C to +125°C | - | - | 7 | | | |
| | | V _{DD} =3.3V | +25°C | - | 2.9 | 5.5 | | | |
| | | | -40°C to +125°C | - | - | 8.3 | | | |
| | | V _{DD} =5.0V | +25°C | - | 3.4 | 6.3 | | | |
| | | | -40°C to +125°C | - | - | 9.6 | | | |
| Threshold voltage (note 3) | V _{TH} | EM6325 – 1.3 | +25°C | 1.290 | 1.31 | 1.330 | V | | |
| | | | -40°C to +85°C | 1.245 | | 1.382 | | | |
| | | | -40°C to +125°C | 1.221 | | 1.387 | | | |
| | | EM6325 – 1.4 | +25°C | 1.359 | 1.38 | 1.401 | | | |
| | | | -40°C to +85°C | 1.311 | | 1.456 | | | |
| | | | -40°C to +125°C | 1.286 | | 1.461 | | | |
| | | EM6325 – 1.6 | +25°C | 1.546 | 1.57 | 1.594 | | | |
| | | | -40°C to +85°C | 1.492 | | 1.656 | | | |
| | | | -40°C to +125°C | 1.463 | | 1.663 | | | |
| | | EM6325 – 1.7 | +25°C | 1.635 | 1.66 | 1.685 | | | |
| | | | -40°C to +85°C | 1.577 | | 1.751 | | | |
| | | | -40°C to +125°C | 1.547 | | 1.758 | | | |
| | | EM6325 – 1.8 | +25°C | 1.773 | 1.80 | 1.827 | | | |
| | | | -40°C to +85°C | 1.710 | | 1.899 | | | |
| | | | -40°C to +125°C | 1.678 | | 1.906 | | | |
| | | EM6325 – 2.2 | +25°C | 2.167 | 2.20 | 2.233 | | | |
| | | | -40°C to +85°C | 2.090 | | 2.321 | | | |
| | | | -40°C to +125°C | 2.050 | | 2.330 | | | |
| | | EM6325 – 2.6 | +25°C | 2.591 | 2.63 | 2.669 | | | |
| | | | -40°C to +85°C | 2.499 | | 2.775 | | | |
| | | | -40°C to +125°C | 2.451 | | 2.785 | | | |
| | | EM6325 – 2.9 | +25°C | 2.886 | 2.93 | 2.974 | | | |
| | | | -40°C to +85°C | 2.784 | | 3.091 | | | |
| | | | -40°C to +125°C | 2.731 | | 3.103 | | | |
| | | EM6325 – 3.1 | +25°C | 3.034 | 3.08 | 3.126 | | | |
| | | | -40°C to +85°C | 2.926 | | 3.249 | | | |
| | | | -40°C to +125°C | 2.871 | | 3.262 | | | |
| | | EM6325 – 4.4 | +25°C | 4.334 | 4.40 | 4.466 | | | |
| | | | -40°C to +85°C | 4.180 | | 4.642 | | | |
| | | | -40°C to +125°C | 4.101 | | 4.660 | | | |
| | | EM6325 – 4.6 | +25°C | 4.561 | 4.63 | 4.699 | | | |
| | | | -40°C to +85°C | 4.399 | | 4.885 | | | |
| | | | -40°C to +125°C | 4.315 | | 4.903 | | | |
| | | Threshold hysteresis | V _{HYS} | T _A =+25°C | - | 2.1%•V _{TH} | | - | V |

Note 1: Production tested at +25°C only. Over temperature limits are guaranteed by design, not production tested.

Note 3: Threshold voltage is specified for V_{DD} falling.



Electrical Characteristics (continued)

Unless otherwise specified: $V_{DD}= 0.9V$ to $5.5V$, $T_A=-40^{\circ}C$ to $+125^{\circ}C$ (note 1).

| Parameter | Symbol | Conditions | Min | Typ | Max | Unit | |
|--|----------------|---|--------------------|------|--------------------|-----------|----|
| Reset timeout period | t_{POR} | (note 2 and 4) V_{DD} from 0V to $V_{TH (typ)}+15\%$ $T_A= +25^{\circ}C$ | EM6325C | 155 | 200 | 224 | ms |
| | | | EM6325A | 0.7 | 1.6 | 3.8 | |
| | | | EM6325B | 19.4 | 25 | 28 | |
| | | | EM6325D | 1240 | 1600 | 1792 | |
| Propagation delay time V_{DD} to \overline{RESET} (RESET) delay | t_P | V_{DD} drops from $V_{TH (typ)}+0.2V$ to $V_{TH (typ)}-0.2V$ (note 2). $T_A= +25^{\circ}C$ | 2 | 130 | 255 | μs | |
| Open-drain \overline{RESET} output Voltage | V_{OL} | $V_{DD}>1V$ | $I_{OL}=100\mu A$ | - | - | 0.3 | V |
| | | $V_{DD}>2.5V$ | $I_{OL}=1.5mA$ | - | - | 0.3 | |
| | | $V_{DD}>5V$ | $I_{OL}=3mA$ | - | - | 0.35 | |
| Push-pull \overline{RESET} / \overline{RESET} Output voltage | V_{OL} | $V_{DD}>1V$ | $I_{OL}=100\mu A$ | - | - | 0.3 | V |
| | | $V_{DD}>2.5V$ | $I_{OL}=1.5mA$ | - | - | 0.3 | |
| | | $V_{DD}>5V$ | $I_{OL}=3mA$ | - | - | 0.35 | |
| | V_{OH} | $V_{DD}>1V$ | $I_{OH}=-30\mu A$ | 0.8 | - | - | |
| | | $V_{DD}>2.5V$ | $I_{OH}=-1.5mA$ | 2 | - | - | |
| | | $V_{DD}>5V$ | $I_{OH}=-3mA$ | 4 | - | - | |
| Output leakage current | I_{LEAK} | Only for EM6325_Y (open-drain) | - | - | 0.5 | μA | |
| MANUAL RESET (MR) | | | | | | | |
| \overline{MR} Input low | $V_{MRT low}$ | $T_A= +25^{\circ}C$ | | | $0.3 \cdot V_{DD}$ | V | |
| \overline{MR} Input high | $V_{MRT high}$ | | $0.7 \cdot V_{DD}$ | | | V | |
| \overline{MR} to Reset delay | t_{MD} | | | 0.3 | | μs | |
| Pulse width at \overline{MR} (note 5) | t_{PMD} | | 1 | | | μs | |
| \overline{MR} Internal Pull-up resistor | R_{MR} | $T_A=-40^{\circ}C$ to $+125^{\circ}C$ | 4.8 | 15 | 31 | $k\Omega$ | |

Note 1: Production tested at $+25^{\circ}C$ only. Over temperature limits are guaranteed by design, not production tested.

Note 2: \overline{RESET} (RESET) open.

Note 4: Standard version for t_{POR} is 200ms (typ), available at all times. Other option (1.6ms, 25ms, 1600ms) are available by mask option and upon minimum order quantity. Please contact EM sales.

Note 5: Pulse width must be greater than $1\mu s$ to ensure the \overline{RESET} (RESET) to go active.

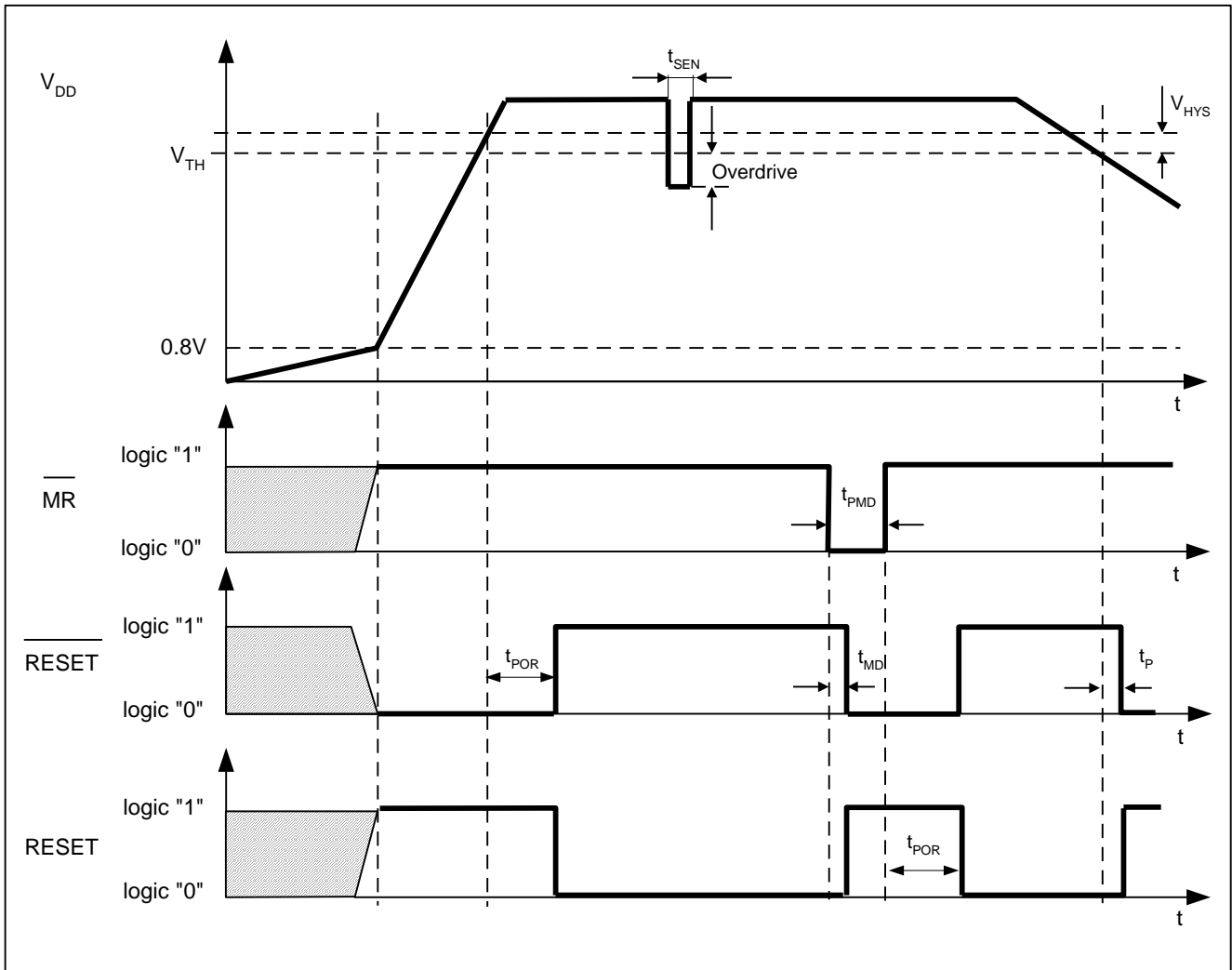
Timing Waveforms

Note 6: t_{SEN} = Maximum Transient Duration. Please refer to figure on the next page.

Note 7: Overdrive = V_{TH} - V_{DD}. Please refer to figure on the next page.

Manual Reset Input

A logic low on $\overline{\text{MR}}$ asserts a reset. Reset remains asserted while $\overline{\text{MR}}$ is low, and for t_{POR} (200ms nominal for EM6325C) after it returns high. $\overline{\text{MR}}$ has an internal 15kΩ pull-up resistor, so it can be left open if unused. This input can be driven with CMOS logic levels or with open-drain outputs. Connect a normally open momentary switch from $\overline{\text{MR}}$ to V_{SS} to create a manual-reset function; debounce circuitry is integrated. If $\overline{\text{MR}}$ is driven from long cable or the device is used in a noisy environment, connect a 0.1μF capacitor from $\overline{\text{MR}}$ to V_{SS} to provide additional noise immunity (stronger external additional pull-up resistor can also be added).

Typical Operating Characteristics

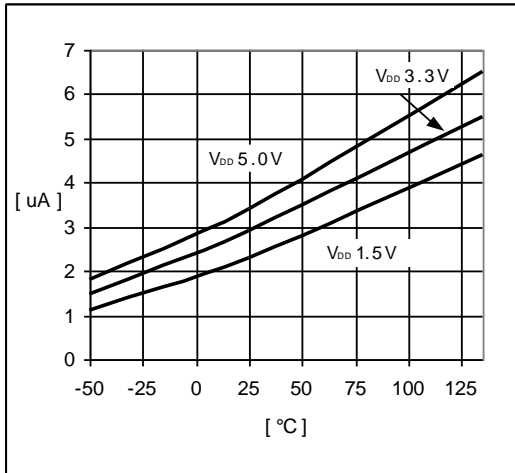
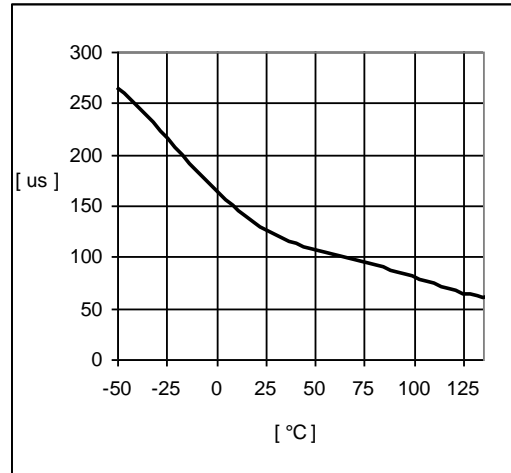
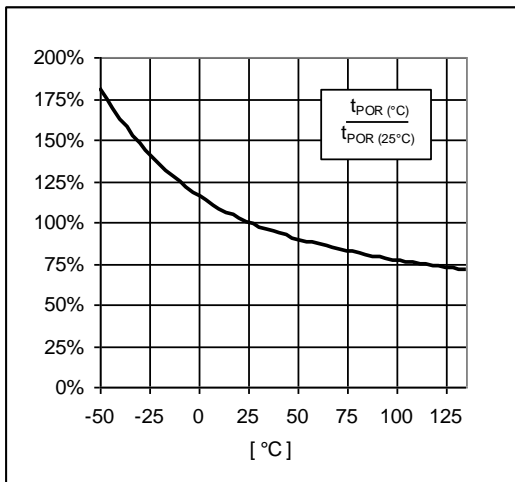
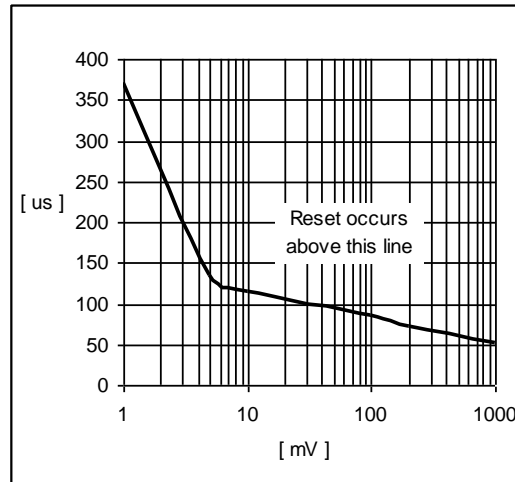
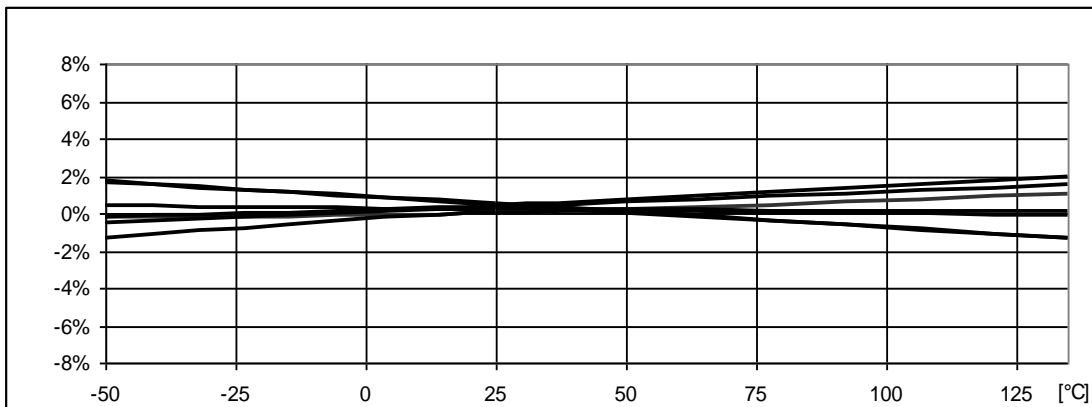
 (Typical values are at $T_A=+25^\circ\text{C}$ unless otherwise noted, $\overline{\text{MR}}$, $\overline{\text{RESET}}$ and RESET open.)

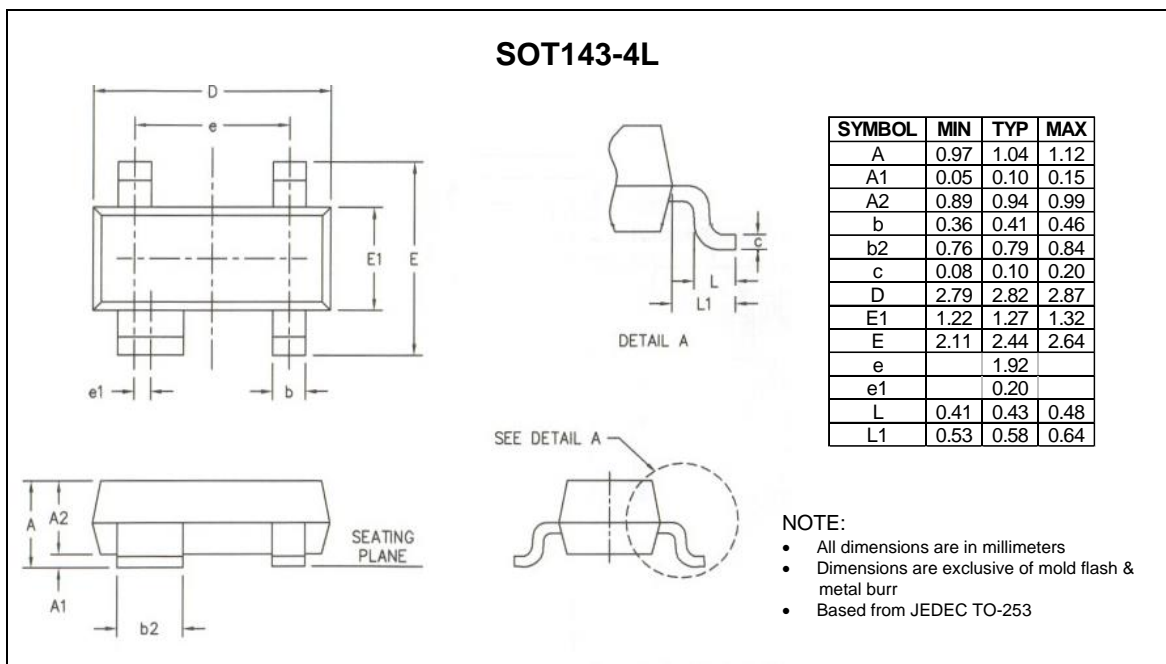
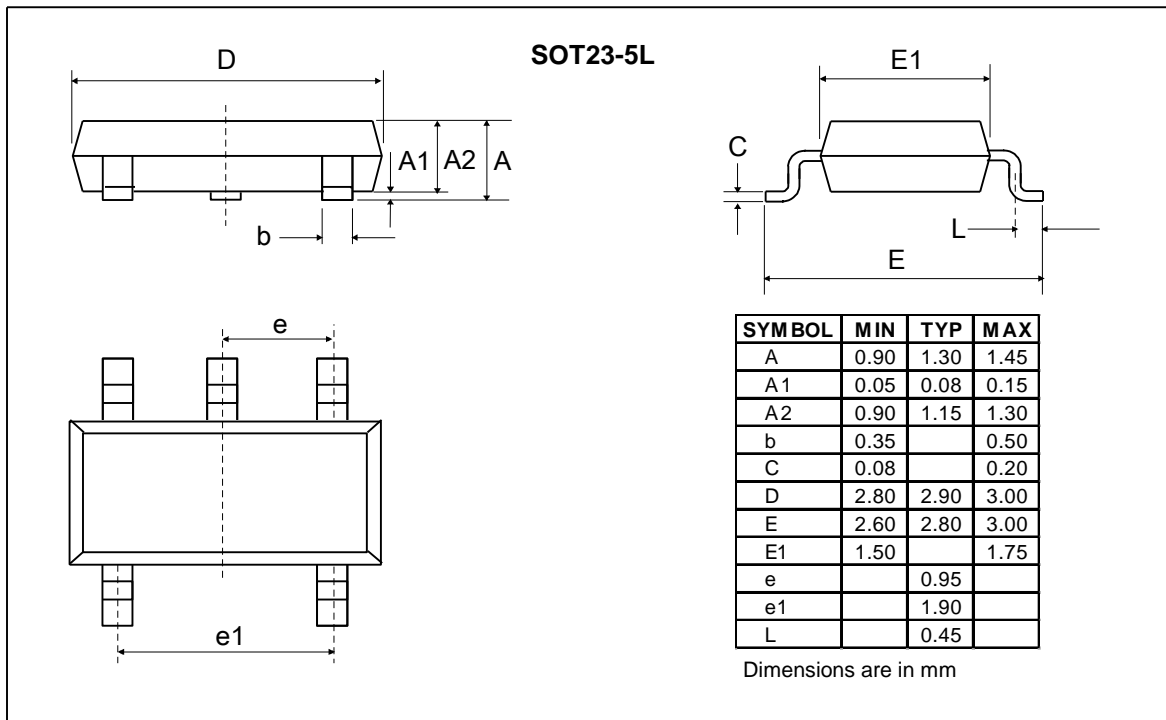
 I_{DD} vs. Temperature

Propagation Time t_P vs. Temperature

Reset Timeout Period t_{POR} vs. Temperature (normalized with respect to t_{POR} 25°C)

Maximum Transient Duration t_{SEN} vs. Overdrive $V_{TH}-V_{DD}$

Threshold Voltage Variation vs. Temperature (normalized)

Package Information



Traceability for small packages

Due to the limited space on the package surface, the bottom marking contains a limited number of characters that provide only partial information for lot traceability. Full information for complete traceability is however provided on the packing labels of the product at delivery from EM. It is highly recommended that the customer insures full lot traceability of EM product in his final product.

EM Microelectronic-Marín SA ("EM") makes no warranties for the use of EM products, other than those expressly contained in EM's applicable General Terms of Sale, located at <http://www.emmicroelectronic.com>. EM assumes no responsibility for any errors which may have crept into this document, reserves the right to change devices or specifications detailed herein at any time without notice, and does not make any commitment to update the information contained herein.

No licenses to patents or other intellectual property rights of EM are granted in connection with the sale of EM products, neither expressly nor implicitly.

In respect of the intended use of EM products by customer, customer is solely responsible for observing existing patents and other intellectual property rights of third parties and for obtaining, as the case may be, the necessary licenses.

Important note: The use of EM products as components in medical devices and/or medical applications, including but not limited to, safety and life supporting systems, where malfunction of such EM products might result in damage to and/or injury or death of persons is expressly prohibited, as EM products are neither destined nor qualified for use as components in such medical devices and/or medical applications. The prohibited use of EM products in such medical devices and/or medical applications is exclusively at the risk of the customer

Product qualification is performed according to internal EM quality standards for industrial products. For any special requirement (eg. automotive grade) please contact EM Microelectronic-Marín S.A.