

Atlas LCR40

Automatic LCR Meter

Model LCR40 (Firmware: 3.72)



Designed and manufactured with pride in the UK

User Guide

© Peak Electronic Design Limited 2002/2021

In the interests of development, information in this guide is subject to change without notice.
E&OE



Want to use it now?

We understand that you want to use your **LCR40** right now. The unit is ready to go and you should have little need to refer to this user guide, but please make sure that you do at least take a look at the very important notices on page 4!

Contents	Page
Introduction.....	3
Important Notices.....	4
Using your LCR40	5
Normal use	5
Probe compensation.....	6
Testing Inductors.....	7
Testing Capacitors.....	8
Testing Resistors	11
Low Resistance and Inductance.....	11
Taking care of your LCR40	12
Battery Replacement.....	12
Self Tests	13
Appendix A – Accessories	14
Appendix B – Component Identification	15
Appendix C – Technical Specifications	17
Appendix D – Troubleshooting.....	18
Appendix E – Statutory Information	20

This user guide has been written to accompany the **LCR40** meter with revision 3.72 firmware. Other revisions of firmware may differ in operation, features and specifications. The firmware version is displayed briefly upon power-up.

Introduction

The **Peak Atlas LCR40** is an advanced instrument that greatly simplifies the testing of passive components.

Traditional LCR bridges can be inherently complex and very time consuming to use.

The **LCR40** does everything automatically, it tells you the component type in addition to component value data.

What's more, the **LCR40** automatically selects the best signal level and frequency for the particular component under test.

The software is smart; all internal calculations are performed with floating point maths. This means that precision isn't lost in the complex internal calculations and all results are displayed in properly formatted and easy-to-read engineering units, eg. 23.6pF.

Summary Features:

- Automatic component identification.
- Automatic test frequency selection (DC, 1kHz, 15kHz and 200kHz).
- Delayed or instant analysis (for hands free operation).
- Auto power-off.
- Probe and test lead compensation.
- Interchangeable probe sets using 2mm connectors.
- Automatic ranging and scaling.
- 1% basic accuracy for resistors.
- 1.5% basic accuracy for inductors and capacitors.

Important Notices

Please observe the following guidelines:

WARNING:

This instrument must NEVER be connected to powered equipment/components or equipment/components with any stored energy (e.g. charged capacitors).

Failure to comply with this warning may result in personal injury, damage to the equipment under test, damage to the LCR40 and invalidation of the manufacturer's warranty.

“Analysis of discrete, unconnected components is recommended.”

 The **LCR40** is designed to provide accurate and reliable information for the majority of supported component types (inductors, capacitors and resistors) as described in the technical specifications. Testing of other component types or component networks may give erroneous and misleading results.

Using your LCR40

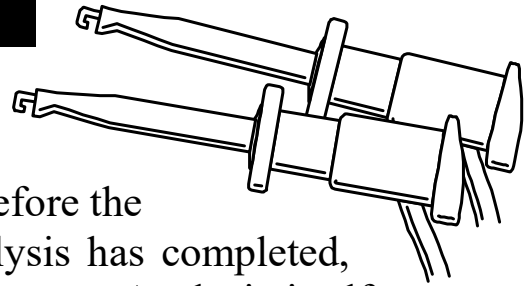

Normal Use

The **LCR40** performs its component analysis before the results are displayed. Therefore, once the analysis has completed, the probes can be disconnected from the component. Analysis itself only takes a few seconds and you can choose to start the analysis after a 5 second delay or immediately.

Delayed Analysis: If you press the **on-test** button the unit will power-up (if it's not already on) and then delay for 5 seconds before analysis of your component starts.

Analysis starts
in 5 seconds...

This can be particularly useful if you need time to use both hands to apply the test probes to the component while the analysis takes place.

Instant Analysis: You can skip the 5 second delay by pressing the **on-test** button again. The analysis will then start immediately.

Analysing...

Scrolling through the results: Results are displayed a screen at a time, simply press the **scroll-off** button to see each screen when you're ready.

If you reach the last screen of results, pressing **scroll-off** will take you to the first results screen again. Remember, you can take your time; and you don't need to keep the component connected.

Starting again: The component analysis can be started again at any time by pressing **on-test**.

Switching off: The unit will automatically switch off after about 60 seconds following the last keypress. If you wish, you can manually switch off by holding down the **scroll-off** button for about 1 second.

Probe Compensation

If you change the probes on your **LCR40**, it is good practice to run through the short compensation procedure. This ensures that the probes' own inductance, capacitance and resistance is automatically taken into account for subsequent measurements.

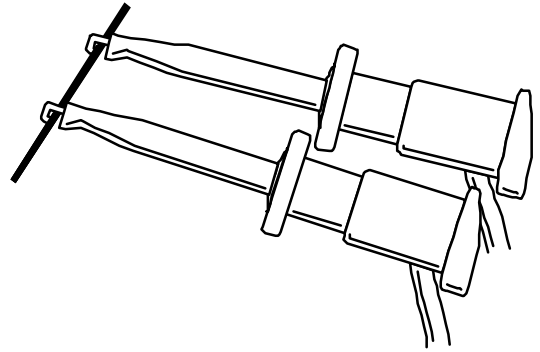

Before you start the compensation procedure, attach a small length of tinned copper wire between the two test probes. Now let the leads rest on a non-conductive surface, try not to touch them during the compensation procedure.

Now press and hold **on-test** until the following is displayed:

Probe
Compensation

After a short delay, the unit will prompt you to short the probes together. As you have already shorted the probes with the piece of wire, the **LCR40** will then ask you to open the probes.

Please short
the probes

Now simultaneously unclip the probes from the small length of wire and let the leads rest without touching them.

Now open
the probes

If this procedure has been successful, the unit will display “OK” and then switch off.

At this point the parasitic and stray characteristics associated with the test leads (and indeed the **LCR40** itself) will be stored in non-volatile memory. All further tests will have these values subtracted from the measured values, therefore displaying the characteristics of the component alone.

 Please note that probe compensation is particularly important when analysing low value inductors, capacitors and resistors.

Testing Inductors

The **LCR40** can analyse most inductors, coils and chokes.

Inductor test frequency: The test frequency that the **LCR40** uses will be automatically selected from 1kHz, 15kHz or 200kHz. The following table shows the test frequencies used for various inductance ranges:

Inductance Range	Test Frequency Used
Between 0 μ H and 0.3mH	200kHz
Between 0.3mH and 4mH	15kHz
Between 4mH and 2H	1kHz

The inductance range for each test frequency shown in the table above is **approximate**. Effects such as DC resistance, hysteresis and Q factor can influence the frequency that the **LCR40** selects for your particular inductor.

Inductance range: Values ranging from about 1 μ H to 2H can be measured, with a minimum resolution of 0.4 μ H. The DC resistance of the inductor is measured from 0.5 Ω to 1k Ω with a minimum resolution of 0.3 Ω .

Inductor results: Following analysis, the inductance is displayed.

Press **scroll-off** to display the frequency at which the inductance was measured.

Pressing the **scroll-off** button again will display the inductor's DC resistance.

Inductance

1.507mH

Test frequency

15kHz

DC Resistance

67.2 ohms



Inductance measured for some components can be dependent on the test frequency used. The effect of frequency on inductance varies depending on the type of windings and core utilised. Even air cored inductors can show significant changes of measured inductance at different frequencies.

Testing Capacitors

The **LCR40** uses two different methods to analyse capacitors, AC impedance analysis for low value capacitors (less than about $1\mu\text{F}$) and DC charge analysis for larger capacitors (about $1\mu\text{F}$ to $10,000\mu\text{F}$).

 Capacitors (particularly electrolytics) can store enough charge that may cause damage to the **LCR40**.

An electrolytic capacitor can even develop its own stored charge that may be sufficient to cause damage to the **LCR40** even after it has been temporarily discharged. This is a characteristic known as dielectric absorption or “Soakage”.

It is vitally important that you ensure the capacitor is fully discharged (ideally for several seconds) to minimise the possibility of damage to the unit.

If you are unsure, measure the voltage across the capacitor using a suitable volt meter before applying the capacitor to the **LCR40**.

The unit will automatically identify the type of capacitor being tested and apply the most appropriate test method.

The capacitance will always be displayed in the most suitable units. To convert between the various units, refer to the following table:

pF (pico-Farads)	nF (nano-Farads)	μF (micro-Farads)
1	0.001	0.000001
1000	1	0.001
1000 000	1000	1
1000 000 000	1000 000	1000

Low Value Capacitors

There is a vast range of low value capacitors available. Types include ceramic, polyester, polystyrene and mylar dielectric capacitors. Generally, low value capacitors tend to be unpolarised. Minimum capacitance resolution is about 0.2pF.

Capacitor test frequency: The **LCR40** uses a high purity sine wave signal of 1kHz, 15kHz or 200kHz to analyse these types of capacitors. The frequency is automatically selected to give the best possible measurement resolution.

The following table shows the test frequencies used for various capacitance ranges:

Capacitance Range	Test Frequency Used
Between 0pF and 1nF	200kHz
Between 1nF and 15nF	15kHz
Between 15nF and 1 μ F	1kHz
Above 1 μ F	DC

The capacitance ranges for each test frequency shown in the table above is approximate. Effects such as leakage, dielectric dissipation and ESR can influence the frequency that the **LCR40** selects for your particular capacitor.

Capacitor results: Following analysis of the capacitor, the capacitance value is displayed first. Press the **scroll-off** button to display the frequency at which the capacitance was measured.

<p>Capacitance 48.3pF</p>

<p>Test frequency 200kHz</p>

Large Capacitors

Capacitors larger than about 1 μ F are treated differently, instead of being tested with an AC signal, they are tested with a DC signal. This is confirmed in the “Test frequency” screen.

Please be patient when testing large value capacitors, it may take several seconds depending on the capacitance.

Capacitance
106.5 μ F

Test frequency
DC

 Capacitors (particularly electrolytics) can store enough charge that may cause damage to the **LCR40**.

An electrolytic capacitor can even develop its own stored charge that may be sufficient to cause damage to the **LCR40** even after it has been temporarily discharged. This is a characteristic known as dielectric absorption or “Soakage”.

It is vitally important that you ensure the capacitor is fully discharged (ideally for several seconds) to minimise the possibility of damage to the unit.

If you are unsure, measure the voltage across the capacitor using a suitable volt meter before applying the capacitor to the **LCR40**.

 Generally, tantalum capacitors and electrolytic capacitors are polarised. The **LCR40**, however, uses a maximum of 1V to test the capacitor and so polarity of the **LCR40** test probes is usually unimportant.

Testing Resistors

Resistance values ranging from 0.5Ω to $2M\Omega$ can be measured, with a minimum resolution of about 0.3Ω . Resistance is measured using a DC signal with a peak voltage of 1V (across an open circuit) and a peak current of about 3mA (through a short circuit).

Resistor results: Following analysis, the resistance value is displayed.

Resistance
332.2k

Low Resistance/Inductance

Low value inductors ($<5\mu\text{H}$) and low value resistors ($<10\Omega$) are treated as a special case by the LCR40. This is because low value inductors and low value resistors can exhibit very similar characteristics at the test frequencies available from the LCR40.

The following message is displayed:

Pressing the **scroll-off** button will display the values of resistance and inductance that the LCR40 has measured.

The test frequency displayed is the frequency used for the measurement of the inductance.

Low Resistance
and Inductance

Resistance
1.3 ohms

Inductance
0.6uH

Test frequency
200kHz

 Please note that probe compensation is particularly important when analysing low value inductors, capacitors and resistors.

Taking care of your LCR40

Battery Replacement

The **LCR40** requires no special maintenance although the battery should be replaced at least every 12 months to prevent leak damage.

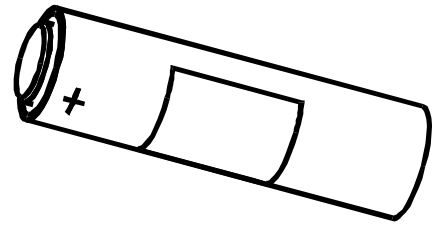

* Low Battery *

If this message is displayed, the battery should be replaced as soon as possible to prevent malfunction or leak damage. Although the unit may continue to

operate following a low battery warning, measurements may be adversely affected.

Battery types: Suitable battery types include 23A, V23A, GP23A, MN21, L1028 or a good quality 12V alkaline equivalent as used in many test instruments and automotive remote key fobs.

Battery access: To replace the battery, place the instrument face-down on a smooth surface and then unscrew the three screws to remove the rear panel. Remove the old battery and insert a new one, taking care to observe the correct polarity. Carefully replace the rear panel, do not over-tighten the screws.

 The GP23A type battery will typically last for about 27 hours of operation which equates to about 1600 operations of 1 minute duration (1 minute is the auto-power-off period). You can improve battery life by switching off the **LCR40** before the auto-power-off period expires by pressing and holding the **scroll-off** button.

Self Tests

Many internal functions are tested each time the unit is powered up. If any of these self tests do not meet tight performance limits, a message will be displayed similar to the following:



Error 02

The unit will then switch off.

It is possible that a temporary condition caused the failure and restarting the unit may clear the problem. If the fault persists, please contact Peak Electronic Design Ltd or an authorised agent with details of the error message for further advice.

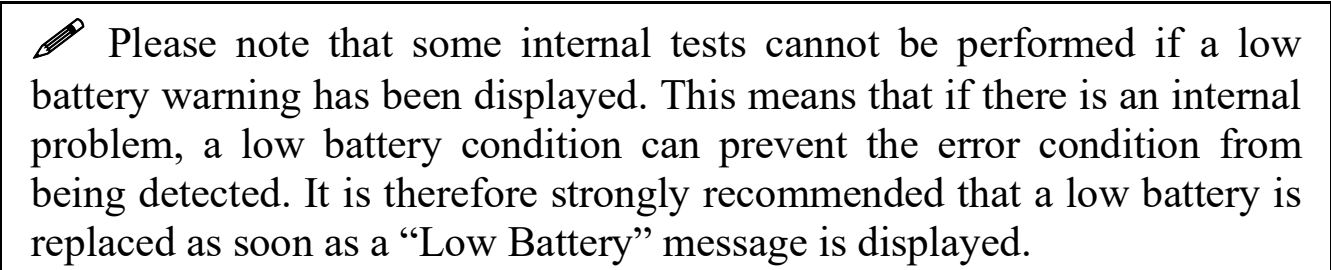

 Please note that some internal tests cannot be performed if a low battery warning has been displayed. This means that if there is an internal problem, a low battery condition can prevent the error condition from being detected. It is therefore strongly recommended that a low battery is replaced as soon as a “Low Battery” message is displayed.

Appendix A - Accessories

A range of useful additions is available to enhance your **LCR40**.

ATC02 – Single Handheld Case

A smart handheld case that offers great protection for your instrument as well as space for extra probes and battery.

ATC55 – Dual Instrument Case

A specially designed case with custom made foam compartments for up to 2 Peak instruments. The case has a tough exterior, ideal for protecting your **LCR40**, probes, spare batteries and user guide.

SMD03 – Surface Mount Tweezer Probes

These tweezers are ideal for testing many types of surface mount device. The tweezers can cope with package sizes of 0402, 0603, 0805, 1206, 1210 and Case A/B/C/D.

Fitting is easy: the tweezers are terminated with standard 2mm female connectors.

Other Probe Accessories

Different probe types are available, specially made for your **LCR40**. Contact Peak Electronic Design Ltd or an authorised agent for more details.

Further information can be seen here:

www.peakelec.co.uk/acatalog/lcr40-and-lcr45-accessories.html

Appendix B – Component Identification

It is important to appreciate that the **LCR40** can only decide on the identity of the component under test using results of the electrical tests that it performs on the component.

The **LCR40** determines the type of component under test according to the following criteria:

Inductor and Resistor Detection

The **LCR40** will distinguish between components that are largely inductive or largely resistive according to the values of inductance and resistance that it has measured. This is illustrated in the following graph.

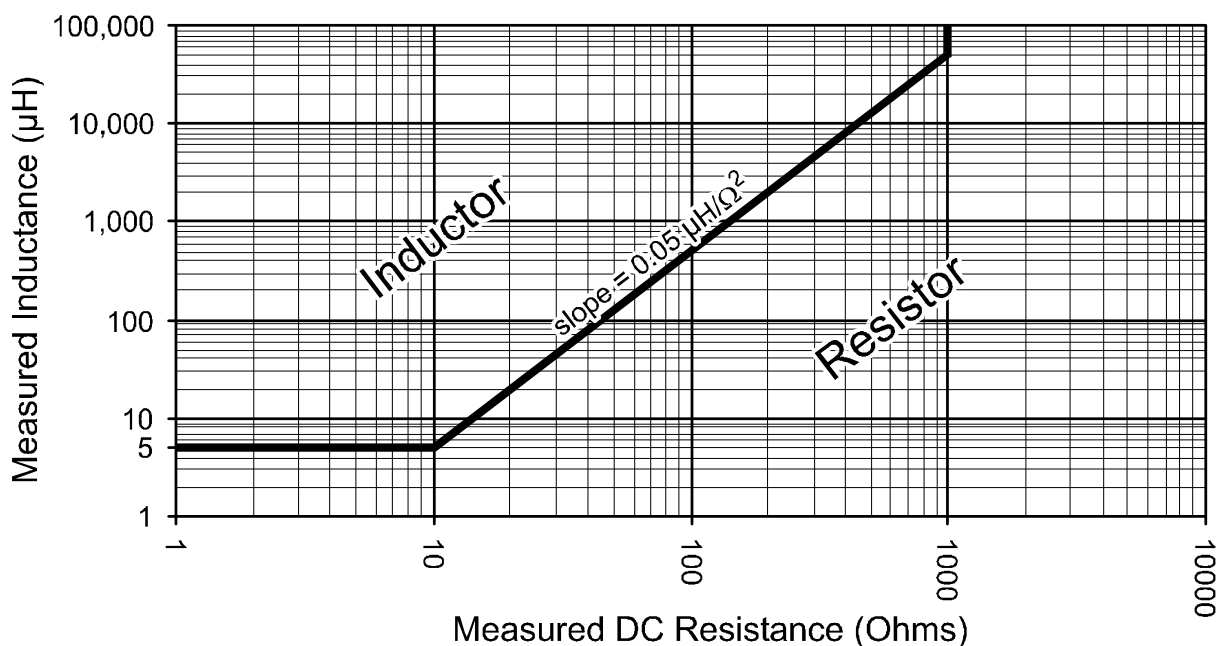

For example, if the inductance of your component is measured at 100µH and it has a DC resistance of 100Ω, then the **LCR40** will tell you that you have a resistor. If however the resistance was only 10Ω, then the **LCR40** will tell you that you have an inductor.

Note that any inductor with a DC resistance of more than 1000Ω will be identified as a resistor.

Capacitor Detection

The **LCR40** will tell you that you have a capacitor if the following criteria are satisfied:

1. If the measured DC resistance is higher than $10\text{M}\Omega$, even if the measured capacitance is very low (such as open probes).

or

2. If the measured DC resistance is between $100\text{k}\Omega$ and $10\text{M}\Omega$ and the measured capacitance is larger than 10pF .

or

3. If the measured DC resistance is between $1\text{k}\Omega$ and $100\text{k}\Omega$ and the measured capacitance is larger than 100nF .

Resistor Detection

Measured characteristics that do not satisfy any of the above criteria (for inductors or capacitors) will be displayed as a resistive element.

Appendix C – Technical Specifications

All values are at 20°C unless otherwise specified.

Parameter	Min	Typ	Max	Note
Resistance	range	1Ω		2MΩ
	resolution	0.3 Ω	0.6Ω	
	accuracy	Typically ±1.0% ±1.2Ω		1,2,6
Capacitance	range	0.5pF		10,000μF
	resolution	0.2pF	0.5pF	
	accuracy	Typically ±1.5% ±1.0pF		1,2,5
Inductance	range	1μH		2H
	resolution	0.4μH	0.8μH	
	accuracy	Typically ±1.5% ±1.6μH		1,2,4
Peak test voltage (across O/C)		-1.05V		+1.05V
Peak test current (thru S/C)		-5.0mA		+5.0mA
Test frequency accuracy	1kHz	-1.5%	±1%	+1.5%
	14.925kHz	-1.5%	±1%	+1.5%
	200kHz	-1.5%	±1%	+1.5%
Sine purity		Typically -60dB 3 rd harmonic		
Operating temperature range		15°C		35°C
Battery operating voltage		8.5V		13V
Battery life		Typically ~1600 operations		

Notes:

1. Within 12 months of factory calibration. Please contact us if you require a full re-calibration and/or certification of traceable calibration.
2. Specified at temperatures between 15°C and 30°C.
3. Subject to acceptable LCD visibility.
4. For inductances between 100μH and 100mH.
5. For capacitances between 200pF and 500nF.
6. For resistances between 10Ω and 1MΩ.
7. Based on <1 minute duration per operation.

Appendix D - Troubleshooting

Problem	Possible Solution
Capacitance measured when probes are open circuit is not close to zero ($\pm 1.0\text{pF}$).	Perform a probe compensation.
Resistance and/or inductance measured when probes are short circuit is not close to zero ($\pm 1.2\Omega$, $\pm 1.6\mu\text{H}$).	Perform a probe compensation.
Measured value doesn't appear to be correct.	Ensure probes are well connected to the component under test for the <u>entire duration</u> of the analysis.
	Ensure that nothing else is connected with the component under test. Make sure that you are not touching the connections.
	The component value may be outside the supported measurement range.
	The component's design frequency may not correspond to the test frequencies used by the LCR40 .
Measured values vary slightly between tests.	The displayed resolution is higher than the measurement resolution to avoid rounding errors. Small variations within the quoted measurement resolutions are normal.
Calibration date is approaching or is in the past.	Don't worry, the LCR40 will carry on working after the "Calibration Due Date". The date is simply a recommendation.

This page is intentionally blank.

Appendix E is on the rear cover of this user guide.

Appendix E – Statutory Information

Peak Satisfaction Warranty

If for any reason you are not completely satisfied with the **LCR40**, within 14 days of purchase, you may return the unit to your distributor. You will receive a refund covering the full purchase price if the unit is returned in perfect condition.

Statutory Warranty

The statutory warranty is valid for 24 months from date of purchase. This warranty covers the cost of repair or replacement due to defects in materials and/or manufacturing faults.

The warranty does not cover malfunction or defects caused by:

- a) Operation outside the scope of the user guide.
- b) Unauthorised access or modification of the unit (except for battery replacement).
- c) Accidental physical damage or abuse.
- d) Normal wear and tear.

The customer's statutory rights are not affected by any of the above. All claims must be accompanied by a proof of purchase.



WEEE (Waste of Electrical and Electronic Equipment), Recycling of Electrical and Electronic Products

It is not permissible to simply throw away electrical and electronic equipment. Instead, these products must enter the recycling process. Each country has implemented the WEEE regulations into national law in slightly different ways. Please follow your national law when you want to dispose of any electrical or electronic products. **More details can be obtained from your national WEEE recycling agency.**

At Peak Electronic Design Ltd we are committed to continual product development and improvement. The specifications of our products are therefore subject to change without notice.

Designed and manufactured in the UK © 2002/2021 Peak Electronic Design Limited - E&OE
www.peakelec.co.uk Tel. +44 (0) 1298 70012