

# STTB 2,5/2P SO - Double-level terminal block



3040892

<https://www.phoenixcontact.com/us/products/3040892>

Please be informed that the data shown in this PDF document is generated from our online catalog. Please find the complete data in the user documentation. Our general terms of use for downloads are valid.



Double-level terminal block, Current and voltage are determined by the plug used., nom. voltage: 500 V, nominal current: 22 A, connection method: Spring-cage/plug-in connection, 1st and 2nd level connection left, Rated cross section: 2.5 mm<sup>2</sup>, cross section: 0.08 mm<sup>2</sup> - 4 mm<sup>2</sup>, 1st and 2nd level connection right, mounting type: NS 35/15, NS 35/7,5, color: gray

## Your advantages

- Potential routing on two levels

## Commercial data

Item number	3040892
Packing unit	50 pc
Minimum order quantity	50 pc
Sales key	BE02
Product key	BE2141
Catalog page	Page 310 (C-1-2019)
GTIN	4046356306201
Weight per piece (including packing)	9.87 g
Weight per piece (excluding packing)	9.87 g
Customs tariff number	85369010
Country of origin	PL

# STTB 2,5/2P SO - Double-level terminal block



3040892

<https://www.phoenixcontact.com/us/products/3040892>

## Technical data

### Notes

General	Current and voltage are determined by the plug used.
---------	--

### Product properties

Product type	Plug-in terminal block
Product family	STTB
Number of connections	4
Number of rows	2
Potentials	2

### Insulation characteristics

Overvoltage category	III
Degree of pollution	3

### Electrical properties

Rated surge voltage	6 kV
Maximum power dissipation for nominal condition	0.77 W

### Connection data

Number of connections per level	2
Nominal cross section	2.5 mm <sup>2</sup>

### 1st and 2nd level connection left

Stripping length	8 mm ... 10 mm
Internal cylindrical gage	A3
Connection in acc. with standard	IEC 61984
Conductor cross section rigid	0.08 mm <sup>2</sup> ... 4 mm <sup>2</sup>
Cross section AWG	28 ... 12 (converted acc. to IEC)
Conductor cross section flexible	0.08 mm <sup>2</sup> ... 2.5 mm <sup>2</sup>
Conductor cross section, flexible [AWG]	28 ... 14 (converted acc. to IEC)
Conductor cross-section flexible (ferrule without plastic sleeve)	0.14 mm <sup>2</sup> ... 2.5 mm <sup>2</sup>
Flexible conductor cross section (ferrule with plastic sleeve)	0.14 mm <sup>2</sup> ... 2.5 mm <sup>2</sup>
2 conductors with the same cross section, flexible, with TWIN ferrule with plastic sleeve	0.5 mm <sup>2</sup>
Nominal current	22 A
Maximum load current	22 A (with 4 mm <sup>2</sup> conductor cross section)
Nominal voltage	500 V
Nominal cross section	2.5 mm <sup>2</sup>

### Dimensions

# STTB 2,5/2P SO - Double-level terminal block



3040892

<https://www.phoenixcontact.com/us/products/3040892>

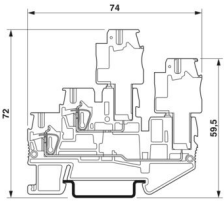
Dimensional drawing	
Width	5.2 mm
End cover width	2.2 mm
Height	71.5 mm
Depth on NS 35/7,5	47.5 mm
Depth on NS 35/15	55 mm

## Material specifications

Color	gray
Flammability rating according to UL 94	V0
Insulating material group	I
Insulating material	PA
Static insulating material application in cold	-60 °C
Temperature index of insulation material (DIN EN 60216-1 (VDE 0304-21))	130 °C
Relative insulation material temperature index (Elec., UL 746 B)	130 °C
Fire protection for rail vehicles (DIN EN 45545-2) R22	HL 1 - HL 3
Fire protection for rail vehicles (DIN EN 45545-2) R23	HL 1 - HL 3
Fire protection for rail vehicles (DIN EN 45545-2) R24	HL 1 - HL 3
Fire protection for rail vehicles (DIN EN 45545-2) R26	HL 1 - HL 3
Calorimetric heat release NFPA 130 (ASTM E 1354)	28 MJ/kg
Surface flammability NFPA 130 (ASTM E 162)	passed
Specific optical density of smoke NFPA 130 (ASTM E 662)	passed
Smoke gas toxicity NFPA 130 (SMP 800C)	passed

## Electrical tests

### Surge voltage test

Test voltage setpoint	7.3 kV
Result	Test passed
Short-time withstand current 2.5 mm <sup>2</sup>	0.3 kA
Result	Test passed

### Power-frequency withstand voltage

Test voltage setpoint	1.89 kV
Result	Test passed

## Mechanical properties

### Mechanical data

# STTB 2,5/2P SO - Double-level terminal block



3040892

<https://www.phoenixcontact.com/us/products/3040892>

Open side panel	Yes
-----------------	-----

## Mechanical tests

### Attachment on the carrier

DIN rail/fixing support	NS 35
Test force setpoint	1 N
Result	Test passed

## Environmental and real-life conditions

### Needle-flame test

Time of exposure	30 s
Result	Test passed

### Oscillation/broadband noise

Specification	DIN EN 50155 (VDE 0115-200):2008-03
Spectrum	Service life test category 1, class B, body mounted
Frequency	$f_1 = 5 \text{ Hz}$ to $f_2 = 150 \text{ Hz}$
ASD level	$0.964 \text{ (m/s}^2\text{)}^2\text{/Hz}$
Acceleration	0.58g
Test duration per axis	5 h
Test directions	X-, Y- and Z-axis
Result	Test passed

### Shocks

Specification	DIN EN 50155 (VDE 0115-200):2008-03
Pulse shape	Half-sine
Acceleration	5g
Shock duration	30 ms
Number of shocks per direction	3
Test directions	X-, Y- and Z-axis (pos. and neg.)
Result	Test passed

### Ambient conditions

Ambient temperature (operation)	-60 °C (max. operating temperature see derating curve)
Ambient temperature (storage/transport)	-25 °C ... 60 °C (for a short time, no longer than 24 h, -60°C to +70°C)
Ambient temperature (assembly)	-5 °C ... 70 °C
Ambient temperature (actuation)	-5 °C ... 70 °C
Permissible humidity (operation)	20 % ... 90 %
Permissible humidity (storage/transport)	30 % ... 70 %

## Standards and regulations

Connection in acc. with standard	IEC 61984
----------------------------------	-----------

## Mounting

# STTB 2,5/2P SO - Double-level terminal block



3040892

<https://www.phoenixcontact.com/us/products/3040892>

Mounting type	NS 35/15
	NS 35/7,5

# STTB 2,5/2P SO - Double-level terminal block

3040892

<https://www.phoenixcontact.com/us/products/3040892>

## Drawings

Dimensional drawing

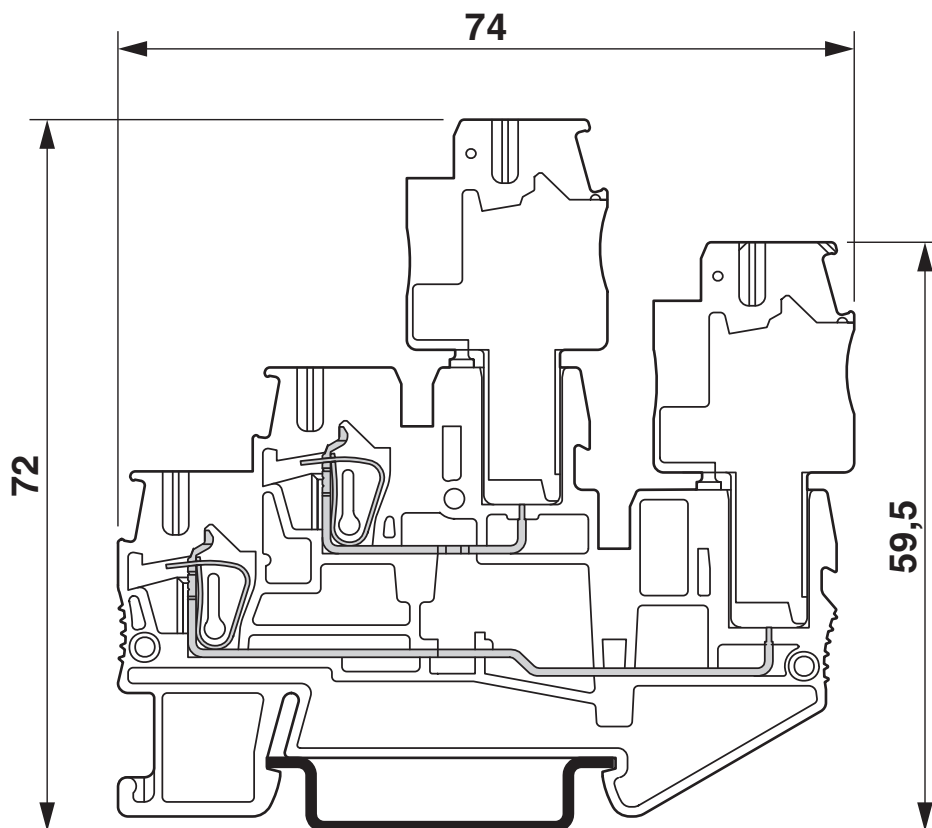

Diagram

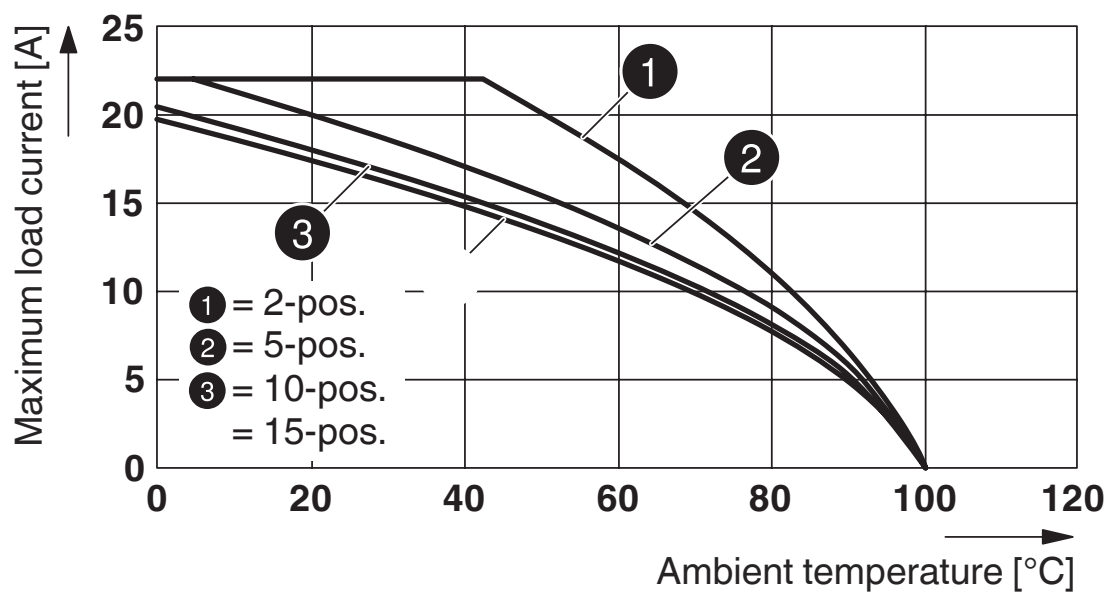

Applies to all male connector variants SP...

# STTB 2,5/2P SO - Double-level terminal block



3040892

<https://www.phoenixcontact.com/us/products/3040892>

Circuit diagram

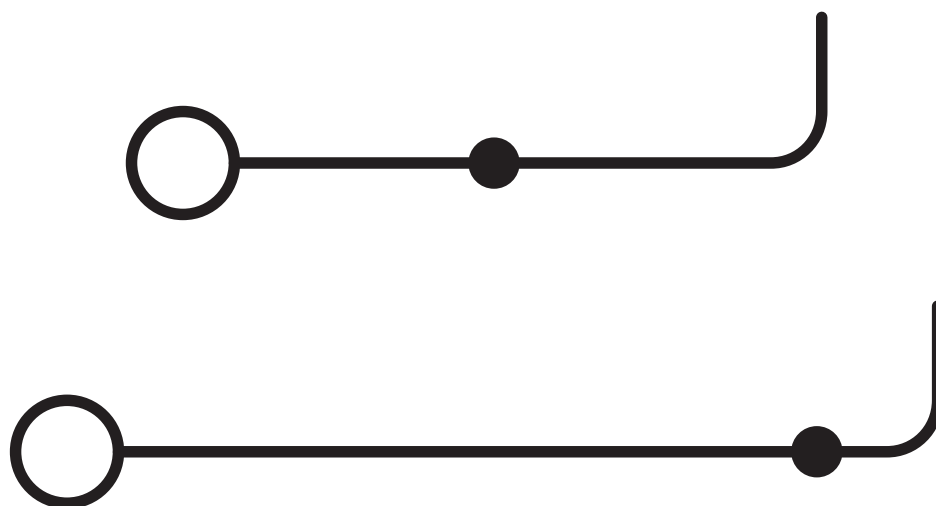

# STTB 2,5/2P SO - Double-level terminal block



3040892

<https://www.phoenixcontact.com/us/products/3040892>

## Approvals

To download certificates, visit the product detail page: <https://www.phoenixcontact.com/us/products/3040892>

 <b>CSA</b> Approval ID: 13631				
	Nominal voltage $U_N$	Nominal current $I_N$	Cross section AWG	Cross section $mm^2$
Use group B	300 V	20 A	28 - 12	-
Use group C	300 V	20 A	28 - 12	-
Use group D	600 V	5 A	28 - 12	-

 <b>IECEE CB Scheme</b> Approval ID: DE1-62736/B1/B2				
--	--	--	--	--

 <b>EAC</b> Approval ID: RU C-DE.BL08.B.00644				
---	--	--	--	--

 <b>LR</b> Approval ID: LR2042068TA				
---	--	--	--	--

 <b>BV</b> Approval ID: 27721/B0 BV				
---	--	--	--	--

 <b>VDE Zeichengenehmigung</b> Approval ID: 40019518				
	Nominal voltage $U_N$	Nominal current $I_N$	Cross section AWG	Cross section $mm^2$
Only flexible conductors	500 V	-	-	0.2 - 2.5
Only rigid conductors	500 V	-	-	0.2 - 4

 <b>cULus Recognized</b> Approval ID: E60425				
	Nominal voltage $U_N$	Nominal current $I_N$	Cross section AWG	Cross section $mm^2$
Use group B	300 V	20 A	28 - 12	-
Use group C	300 V	20 A	28 - 12	-
Use group D	600 V	5 A	28 - 12	-



# STTB 2,5/2P SO - Double-level terminal block



3040892

<https://www.phoenixcontact.com/us/products/3040892>

	600 V	5 A	28 - 12	-
--	-------	-----	---------	---

## DNV

Approval ID: TAE00001CS

# STTB 2,5/2P SO - Double-level terminal block



3040892

<https://www.phoenixcontact.com/us/products/3040892>

## Classifications

### ECLASS

ECLASS-11.0	27141120
ECLASS-13.0	27250117

### ETIM

ETIM 9.0	EC000897
----------	----------

### UNSPSC

UNSPSC 21.0	39121400
-------------	----------

# STTB 2,5/2P SO - Double-level terminal block



3040892

<https://www.phoenixcontact.com/us/products/3040892>

## Environmental product compliance

### EU RoHS

Fulfills EU RoHS substance requirements	Yes, No exemptions
---	--------------------

### China RoHS

Environment friendly use period (EFUP)	EFUP-E
	No hazardous substances above the limits

### EU REACH SVHC

REACH candidate substance (CAS No.)	No substance above 0.1 wt%
-------------------------------------	----------------------------

# STTB 2,5/2P SO - Double-level terminal block

3040892

<https://www.phoenixcontact.com/us/products/3040892>

## Accessories

 Note: Applying some accessories below might limit this product.

### FBS 2-5 - Plug-in bridge

3030161

<https://www.phoenixcontact.com/us/products/3030161>



Plug-in bridge, pitch: 5.2 mm, number of positions: 2, length: 23 mm, color: red

 Max. current carrying capacity: 24 A

### FBS 3-5 - Plug-in bridge

3030174

<https://www.phoenixcontact.com/us/products/3030174>



Plug-in bridge, pitch: 5.2 mm, number of positions: 3, length: 23 mm, color: red

 Max. current carrying capacity: 24 A

# STTB 2,5/2P SO - Double-level terminal block

3040892

<https://www.phoenixcontact.com/us/products/3040892>

## FBS 4-5 - Plug-in bridge

3030187

<https://www.phoenixcontact.com/us/products/3030187>



Plug-in bridge, pitch: 5.2 mm, number of positions: 4, length: 23 mm, color: red

 Max. current carrying capacity: 24 A

---

## FBS 5-5 - Plug-in bridge

3030190

<https://www.phoenixcontact.com/us/products/3030190>



Plug-in bridge, pitch: 5.2 mm, number of positions: 5, length: 23 mm, color: red

 Max. current carrying capacity: 24 A

# STTB 2,5/2P SO - Double-level terminal block

3040892

<https://www.phoenixcontact.com/us/products/3040892>



## FBS 10-5 - Plug-in bridge

3030213

<https://www.phoenixcontact.com/us/products/3030213>



Plug-in bridge, pitch: 5.2 mm, number of positions: 10, length: 23 mm, color: red

 Max. current carrying capacity: 24 A

---

## FBS 20-5 - Plug-in bridge

3030226

<https://www.phoenixcontact.com/us/products/3030226>



Plug-in bridge, pitch: 5.2 mm, number of positions: 20, color: red

 Max. current carrying capacity: 24 A

# STTB 2,5/2P SO - Double-level terminal block

3040892

<https://www.phoenixcontact.com/us/products/3040892>



## FBS 50-5 - Plug-in bridge

3038930

<https://www.phoenixcontact.com/us/products/3038930>



Plug-in bridge, pitch: 5.2 mm, number of positions: 50, color: red

 Max. current carrying capacity: 24 A

---

## FBS 2-5 BU - Plug-in bridge

3036877

<https://www.phoenixcontact.com/us/products/3036877>



Plug-in bridge, pitch: 5.2 mm, number of positions: 2, color: blue

 Max. current carrying capacity: 24 A

# STTB 2,5/2P SO - Double-level terminal block

3040892

<https://www.phoenixcontact.com/us/products/3040892>



## FBS 3-5 BU - Plug-in bridge

3036880

<https://www.phoenixcontact.com/us/products/3036880>



Plug-in bridge, pitch: 5.2 mm, number of positions: 3, color: blue

 Max. current carrying capacity: 24 A

---

## FBS 4-5 BU - Plug-in bridge

3036893

<https://www.phoenixcontact.com/us/products/3036893>



Plug-in bridge, pitch: 5.2 mm, number of positions: 4, color: blue

 Max. current carrying capacity: 24 A



# STTB 2,5/2P SO - Double-level terminal block

3040892

<https://www.phoenixcontact.com/us/products/3040892>



## FBS 5-5 BU - Plug-in bridge

3036903

<https://www.phoenixcontact.com/us/products/3036903>



Plug-in bridge, pitch: 5.2 mm, number of positions: 5, color: blue

 Max. current carrying capacity: 24 A

---

## FBS 10-5 BU - Plug-in bridge

3036916

<https://www.phoenixcontact.com/us/products/3036916>



Plug-in bridge, pitch: 5.2 mm, number of positions: 10, color: blue

 Max. current carrying capacity: 24 A

# STTB 2,5/2P SO - Double-level terminal block

3040892

<https://www.phoenixcontact.com/us/products/3040892>



## FBS 20-5 BU - Plug-in bridge

3036929

<https://www.phoenixcontact.com/us/products/3036929>



Plug-in bridge, pitch: 5.2 mm, number of positions: 20, color: blue

 Max. current carrying capacity: 24 A

---

## FBS 50-5 BU - Plug-in bridge

3032114

<https://www.phoenixcontact.com/us/products/3032114>

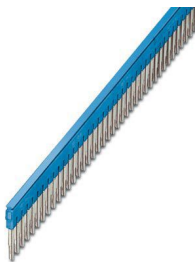

Plug-in bridge, pitch: 5.2 mm, number of positions: 50, color: blue

 Max. current carrying capacity: 24 A

# STTB 2,5/2P SO - Double-level terminal block

3040892

<https://www.phoenixcontact.com/us/products/3040892>

## FBS 2-5 GY - Plug-in bridge

3038969

<https://www.phoenixcontact.com/us/products/3038969>



Plug-in bridge, pitch: 5.2 mm, number of positions: 2, color: gray

 Max. current carrying capacity: 24 A

---

## FBS 3-5 GY - Plug-in bridge

3038972

<https://www.phoenixcontact.com/us/products/3038972>



Plug-in bridge, pitch: 5.2 mm, number of positions: 3, color: gray

 Max. current carrying capacity: 24 A

---

# STTB 2,5/2P SO - Double-level terminal block

3040892

<https://www.phoenixcontact.com/us/products/3040892>



## FBS 4-5 GY - Plug-in bridge

3038985

<https://www.phoenixcontact.com/us/products/3038985>



Plug-in bridge, pitch: 5.2 mm, number of positions: 4, color: gray

 Max. current carrying capacity: 24 A

---

## FBS 5-5 GY - Plug-in bridge

3038998

<https://www.phoenixcontact.com/us/products/3038998>



Plug-in bridge, pitch: 5.2 mm, number of positions: 5, color: gray

 Max. current carrying capacity: 24 A

# STTB 2,5/2P SO - Double-level terminal block

3040892

<https://www.phoenixcontact.com/us/products/3040892>



## FBS 10-5 GY - Plug-in bridge

3039007

<https://www.phoenixcontact.com/us/products/3039007>



Plug-in bridge, pitch: 5.2 mm, number of positions: 10, color: gray

 Max. current carrying capacity: 24 A

---

## FBS 20-5 GY - Plug-in bridge

3038671

<https://www.phoenixcontact.com/us/products/3038671>



Plug-in bridge, pitch: 5.2 mm, number of positions: 20, color: gray

 Max. current carrying capacity: 24 A

# STTB 2,5/2P SO - Double-level terminal block

3040892

<https://www.phoenixcontact.com/us/products/3040892>



## FBS 50-5 GY - Plug-in bridge

3032127

<https://www.phoenixcontact.com/us/products/3032127>



Plug-in bridge, pitch: 5.2 mm, number of positions: 50, color: gray

 Max. current carrying capacity: 24 A

---

## FBSR 2-5 - Plug-in bridge

3033702

<https://www.phoenixcontact.com/us/products/3033702>



Plug-in bridge, pitch: 5.2 mm, number of positions: 2, color: red

 Max. current carrying capacity: 17.5 A

# STTB 2,5/2P SO - Double-level terminal block

3040892

<https://www.phoenixcontact.com/us/products/3040892>



## FBSR 3-5 - Plug-in bridge

3001591

<https://www.phoenixcontact.com/us/products/3001591>



Plug-in bridge, pitch: 5.2 mm, number of positions: 3, color: red

 Max. current carrying capacity: 17.5 A

---

## FBSR 4-5 - Plug-in bridge

3001592

<https://www.phoenixcontact.com/us/products/3001592>



Plug-in bridge, pitch: 5.2 mm, number of positions: 4, color: red

 Max. current carrying capacity: 17.5 A

# STTB 2,5/2P SO - Double-level terminal block

3040892

<https://www.phoenixcontact.com/us/products/3040892>



## FBSR 5-5 - Plug-in bridge

3001593

<https://www.phoenixcontact.com/us/products/3001593>

Plug-in bridge, pitch: 5.2 mm, number of positions: 5, color: red



 Max. current carrying capacity: 17.5 A

---

## FBSR 10-5 - Plug-in bridge

3033710

<https://www.phoenixcontact.com/us/products/3033710>

Plug-in bridge, pitch: 5.2 mm, number of positions: 10, color: red



 Max. current carrying capacity: 17.5 A



# STTB 2,5/2P SO - Double-level terminal block



3040892

<https://www.phoenixcontact.com/us/products/3040892>

## D-STTB 2,5/2P - End cover

3040096

<https://www.phoenixcontact.com/us/products/3040096>

End cover, depth: 39.65 mm, width: 2.2 mm, height: 71.5 mm, color: gray



---

## ATP-STTB 4 - Partition plate

3030747

<https://www.phoenixcontact.com/us/products/3030747>

Partition plate, depth: 53 mm, width: 2 mm, height: 88.7 mm, color: gray



# STTB 2,5/2P SO - Double-level terminal block

3040892

<https://www.phoenixcontact.com/us/products/3040892>

## PC - Coding star

3040588

<https://www.phoenixcontact.com/us/products/3040588>



Coding star, 4-section, depth: 6 mm, width: 3 mm, height: 3 mm, color: red

---

## CEC 2,5 - Filler plug

3062757

<https://www.phoenixcontact.com/us/products/3062757>



Cover for conductor shaft, 10-pos., for spring cage terminal blocks (ST) and terminal blocks with push-in technology (PT) with a width of 5.2 mm

# STTB 2,5/2P SO - Double-level terminal block

3040892

<https://www.phoenixcontact.com/us/products/3040892>



## P-CO 2-5 R47K - Component connector

3032447

<https://www.phoenixcontact.com/us/products/3032447>



Component connector, with 47 kOhm resistance for wire-break monitoring, pitch: 5.2 mm, depth: 34.8 mm, width: 4.1 mm, height: 8.9 mm, number of positions: 2, color: black

---

## WST 2,5 - Warning cover

3030941

<https://www.phoenixcontact.com/us/products/3030941>



Warning cover, 5-pos., for terminal width: 5.2 mm

# STTB 2,5/2P SO - Double-level terminal block

3040892

<https://www.phoenixcontact.com/us/products/3040892>

## LPO 2,5/E - Pick-off plug

3270516

<https://www.phoenixcontact.com/us/products/3270516>



Pick-off plug, nom. voltage: 800 V, nominal current: 24 A, number of positions: 1, connection method: Push-in connection, Rated cross section: 2.5 mm<sup>2</sup>, cross section: 0.14 mm<sup>2</sup>- 4 mm<sup>2</sup>, color: gray

---

## LPO 2,5 - Pick-off plug

3270517

<https://www.phoenixcontact.com/us/products/3270517>



Pick-off plug, nom. voltage: 800 V, nominal current: 24 A, number of positions: 1, connection method: Push-in connection, Rated cross section: 2.5 mm<sup>2</sup>, cross section: 0.14 mm<sup>2</sup>- 4 mm<sup>2</sup>, color: gray

# STTB 2,5/2P SO - Double-level terminal block



3040892

<https://www.phoenixcontact.com/us/products/3040892>

## LPS-5/E - Service connector

3270520

<https://www.phoenixcontact.com/us/products/3270520>



Service connector, nom. voltage: 800 V, nominal current: 24 A, number of positions: 1, connection method: Push-in connection, Rated cross section: 2.5 mm<sup>2</sup>, cross section: 0.14 mm<sup>2</sup>- 4 mm<sup>2</sup>, color: red

---

## LPS-5 - Service connector

3270521

<https://www.phoenixcontact.com/us/products/3270521>



Service connector, nom. voltage: 800 V, nominal current: 24 A, number of positions: 1, connection method: Push-in connection, Rated cross section: 2.5 mm<sup>2</sup>, cross section: 0.14 mm<sup>2</sup>- 4 mm<sup>2</sup>, color: red

## STTB 2,5/2P SO - Double-level terminal block

3040892

<https://www.phoenixcontact.com/us/products/3040892>



## NS 35/ 7,5 PERF 2000MM - DIN rail perforated

0801733

<https://www.phoenixcontact.com/us/products/0801733>



DIN rail perforated, Pack of 25 (50 m), acc. to EN 60715, material: Steel, galvanized, passivated with a thick layer, Standard profile, color: silver

---

## NS 35/ 7,5 UNPERF 2000MM - DIN rail, unperforated

0801681

<https://www.phoenixcontact.com/us/products/0801681>



DIN rail, unperforated, Pack of 25 (50 m), acc. to EN 60715, material: Steel, galvanized, passivated with a thick layer, Standard profile, color: silver

## STTB 2,5/2P SO - Double-level terminal block

3040892

<https://www.phoenixcontact.com/us/products/3040892>



## NS 35/ 7,5 WH PERF 2000MM - DIN rail perforated

1204119

<https://www.phoenixcontact.com/us/products/1204119>



DIN rail perforated, Pack of 25 (50 m), acc. to EN 60715, material: Steel, Galvanized, white passivated, Standard profile, color: silver

---

## NS 35/ 7,5 WH UNPERF 2000MM-VPE 10 - DIN rail, unperforated

1204122

<https://www.phoenixcontact.com/us/products/1204122>



DIN rail, unperforated, Pack of 10 (20 m), acc. to EN 60715, material: Steel, Galvanized, white passivated, Standard profile, color: silver

# STTB 2,5/2P SO - Double-level terminal block

3040892

<https://www.phoenixcontact.com/us/products/3040892>



## NS 35/ 7,5 AL UNPERF 2000MM - DIN rail, unperforated

0801704

<https://www.phoenixcontact.com/us/products/0801704>



DIN rail, unperforated, Pack of 25 (50 m), acc. to EN 60715, material: Aluminum, uncoated, Standard profile, color: silver

---

## NS 35/ 7,5 ZN PERF 2000MM - DIN rail perforated

1206421

<https://www.phoenixcontact.com/us/products/1206421>



DIN rail perforated, Pack of 25 (50 m), acc. to EN 60715, material: Steel, galvanized, Standard profile, color: silver



# STTB 2,5/2P SO - Double-level terminal block

3040892

<https://www.phoenixcontact.com/us/products/3040892>



## NS 35/ 7,5 ZN UNPERF 2000MM - DIN rail, unperforated

1206434

<https://www.phoenixcontact.com/us/products/1206434>



DIN rail, unperforated, Pack of 25 (50 m), acc. to EN 60715, material: Steel, galvanized, Standard profile, color: silver

---

## NS 35/ 7,5 CU UNPERF 2000MM-VPE 10 - DIN rail, unperforated

0801762

<https://www.phoenixcontact.com/us/products/0801762>



DIN rail, unperforated, Pack of 10 (20 m), acc. to EN 60715, material: Copper, uncoated, Standard profile, color: copper-colored

# STTB 2,5/2P SO - Double-level terminal block

3040892

<https://www.phoenixcontact.com/us/products/3040892>



## NS 35/ 7,5 CAP - End cap

1206560

<https://www.phoenixcontact.com/us/products/1206560>

DIN rail end piece, for DIN rail NS 35/7.5



---

## NS 35/15 PERF 2000MM - DIN rail perforated

1201730

<https://www.phoenixcontact.com/us/products/1201730>



DIN rail perforated, Pack of 25 (50 m), similar to EN 60715, material: Steel, galvanized, passivated with a thick layer, Standard profile, color: silver

# STTB 2,5/2P SO - Double-level terminal block

3040892

<https://www.phoenixcontact.com/us/products/3040892>



## NS 35/15 UNPERF 2000MM - DIN rail, unperforated

1201714

<https://www.phoenixcontact.com/us/products/1201714>



DIN rail, unperforated, Pack of 25 (50 m), similar to EN 60715, material: Steel, galvanized, passivated with a thick layer, Standard profile, color: silver

---

## NS 35/15 WH PERF 2000MM - DIN rail perforated

0806602

<https://www.phoenixcontact.com/us/products/0806602>



DIN rail perforated, Pack of 25 (50 m), similar to EN 60715, material: Steel, Galvanized, white passivated, Standard profile, color: white

# STTB 2,5/2P SO - Double-level terminal block

3040892

<https://www.phoenixcontact.com/us/products/3040892>



## NS 35/15 WH UNPERF 2000MM-VPE 10 - DIN rail, unperforated

1204135

<https://www.phoenixcontact.com/us/products/1204135>



DIN rail, unperforated, Pack of 10 (20 m), similar to EN 60715, material: Steel, Galvanized, white passivated, Standard profile, color: silver

---

## NS 35/15 AL UNPERF 2000MM - DIN rail, unperforated

1201756

<https://www.phoenixcontact.com/us/products/1201756>



DIN rail, unperforated, similar to EN 60715, material: Aluminum, uncoated, Standard profile, color: silver

# STTB 2,5/2P SO - Double-level terminal block

3040892

<https://www.phoenixcontact.com/us/products/3040892>



## NS 35/15 ZN PERF 2000MM - DIN rail perforated

1206599

<https://www.phoenixcontact.com/us/products/1206599>



DIN rail perforated, Pack of 25 (50 m), similar to EN 60715, material: Steel, galvanized, Standard profile, color: silver

---

## NS 35/15 ZN UNPERF 2000MM - DIN rail, unperforated

1206586

<https://www.phoenixcontact.com/us/products/1206586>



DIN rail, unperforated, Pack of 25 (50 m), similar to EN 60715, material: Steel, galvanized, Standard profile, color: silver

# STTB 2,5/2P SO - Double-level terminal block

3040892

<https://www.phoenixcontact.com/us/products/3040892>



## NS 35/15 CU UNPERF 2000MM-VPE 10 - DIN rail, unperforated

1201895

<https://www.phoenixcontact.com/us/products/1201895>



DIN rail, unperforated, Pack of 10 (20 m), similar to EN 60715, material: Copper, uncoated, Standard profile, color: copper-colored

---

## NS 35/15 CAP - End cap

1206573

<https://www.phoenixcontact.com/us/products/1206573>

DIN rail end piece, for DIN rail NS 35/15



# STTB 2,5/2P SO - Double-level terminal block

3040892

<https://www.phoenixcontact.com/us/products/3040892>



## NS 35/15-2,3 UNPERF 2000MM-VPE 10 - DIN rail, unperforated

1201798

<https://www.phoenixcontact.com/us/products/1201798>



DIN rail, unperforated, Pack of 10 (20 m), acc. to EN 60715, material: Steel, galvanized, passivated with a thick layer, Standard profile 2.3 mm, color: silver

---

## ZBF 5:UNBEDRUCKT - Zack Marker strip, flat

0808642

<https://www.phoenixcontact.com/us/products/0808642>



Zack Marker strip, flat, Strip, white, unlabeled, can be labeled with: PLOTMARK, CMS-P1-PLOTTER, mounting type: snapped, for terminal block width: 5 mm, lettering field size: 5.1 x 5.2 mm, Number of individual labels: 10

# STTB 2,5/2P SO - Double-level terminal block



3040892

<https://www.phoenixcontact.com/us/products/3040892>

## ZBF 5 CUS - Zack Marker strip, flat

0825025

<https://www.phoenixcontact.com/us/products/0825025>



Zack Marker strip, flat, can be ordered: Strip, white, labeled according to customer specifications, mounting type: snap into flat marker groove, for terminal block width: 5 mm, lettering field size: 5.15 x 5.15 mm, Number of individual labels: 10

---

## ZBF 5,LGS:FORTL.ZAHLEN - Zack Marker strip, flat

0808671

<https://www.phoenixcontact.com/us/products/0808671>



Zack Marker strip, flat, Strip, white, labeled, printed horizontally: consecutive numbers 1 ... 10, 11 ... 20, etc. up to 491 ... 500, mounting type: snapped, for terminal block width: 5 mm, lettering field size: 5.15 x 5.15 mm, Number of individual labels: 10



# STTB 2,5/2P SO - Double-level terminal block



3040892

<https://www.phoenixcontact.com/us/products/3040892>

## ZBF 5,QR:FORTL.ZAHLEN - Zack Marker strip, flat

0808697

<https://www.phoenixcontact.com/us/products/0808697>



Zack Marker strip, flat, Strip, white, labeled, Printed vertically: consecutive numbers 1 ... 10, 11 ... 20, etc. up to 91 ... 100, mounting type: snapped, for terminal block width: 5 mm, lettering field size: 5.15 x 5.15 mm, Number of individual labels: 10

---

## ZBF 5,LGS:GERADE ZAHLEN - Zack Marker strip, flat

0810821

<https://www.phoenixcontact.com/us/products/0810821>



Zack Marker strip, flat, Strip, white, labeled, printed horizontally: consecutive even numbers 2 ... 20, 22 ... 40, etc. up to 82 ... 100, mounting type: snapped, for terminal block width: 5 mm, lettering field size: 5.15 x 5.15 mm, Number of individual labels: 10

# STTB 2,5/2P SO - Double-level terminal block



3040892

<https://www.phoenixcontact.com/us/products/3040892>

## ZBF 5,LGS:UNGERADE ZAHLEN - Zack Marker strip, flat

0810863

<https://www.phoenixcontact.com/us/products/0810863>



Zack Marker strip, flat, Strip, white, labeled, printed horizontally: Odd numbers 1 - 19, 21 - 39, etc. up to 81 - 99, mounting type: snapped, for terminal block width: 5 mm, lettering field size: 5.15 x 5.15 mm, Number of individual labels: 10

---

## UC-TMF 5 - Marker for terminal blocks

0818153

<https://www.phoenixcontact.com/us/products/0818153>

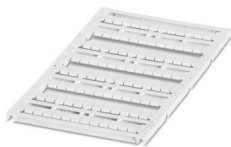

Marker for terminal blocks, Sheet, white, unlabeled, can be labeled with: BLUEMARK ID COLOR, BLUEMARK ID, BLUEMARK CLED, PLOTMARK, CMS-P1-PLOTTER, mounting type: snapped, for terminal block width: 5.2 mm, lettering field size: 4.6 x 5.1 mm, Number of individual labels: 96

# STTB 2,5/2P SO - Double-level terminal block

3040892

<https://www.phoenixcontact.com/us/products/3040892>



## UC-TMF 5 CUS - Marker for terminal blocks

0824638

<https://www.phoenixcontact.com/us/products/0824638>



Marker for terminal blocks, can be ordered: by sheet, white, labeled according to customer specifications, mounting type: snap into flat marker groove, for terminal block width: 5.2 mm, lettering field size: 4.6 x 5.1 mm, Number of individual labels: 96

---

## UCT-TMF 5 - Marker for terminal blocks

0828744

<https://www.phoenixcontact.com/us/products/0828744>



Marker for terminal blocks, Sheet, white, unlabeled, can be labeled with: TOPMARK NEO, TOPMARK LASER, BLUEMARK ID COLOR, BLUEMARK ID, BLUEMARK CLED, THERMOMARK PRIME, THERMOMARK CARD 2.0, THERMOMARK CARD, mounting type: snapped, for terminal block width: 5.2 mm, lettering field size: 4.4 x 4.7 mm, Number of individual labels: 72

## STTB 2,5/2P SO - Double-level terminal block

3040892

<https://www.phoenixcontact.com/us/products/3040892>



## UCT-TMF 5 CUS - Marker for terminal blocks

0829658

<https://www.phoenixcontact.com/us/products/0829658>



Marker for terminal blocks, can be ordered: by sheet, white, labeled according to customer specifications, mounting type: snap into flat marker groove, for terminal block width: 5.2 mm, lettering field size: 4.4 x 4.7 mm, Number of individual labels: 72

---

## ISH 2,5/0,2 - Insulating sleeve

3002843

<https://www.phoenixcontact.com/us/products/3002843>



Insulating sleeve, color: white

# STTB 2,5/2P SO - Double-level terminal block



3040892

<https://www.phoenixcontact.com/us/products/3040892>

## ISH 2,5/0,5 - Insulating sleeve

3002856

<https://www.phoenixcontact.com/us/products/3002856>



Insulating sleeve, color: gray

---

## ISH 2,5/1,0 - Insulating sleeve

3002869

<https://www.phoenixcontact.com/us/products/3002869>



Insulating sleeve, color: black

# STTB 2,5/2P SO - Double-level terminal block

3040892

<https://www.phoenixcontact.com/us/products/3040892>



## PAI-4-N GY - Test adapter

3032871

<https://www.phoenixcontact.com/us/products/3032871>



4 mm test adapter, for terminal blocks with 5.2 mm, 6.2 mm and 8.2 mm pitch

---

## PS-5 - Test plug

3030983

<https://www.phoenixcontact.com/us/products/3030983>



Test plug, Modular test plug, number of positions: 1, color: red

# STTB 2,5/2P SO - Double-level terminal block



3040892

<https://www.phoenixcontact.com/us/products/3040892>

## DP PS-5 - Spacer plate

3036725

<https://www.phoenixcontact.com/us/products/3036725>



Spacer plate, depth: 29 mm, width: 5.2 mm, height: 22.4 mm, number of positions: 1, color: red

---

## PS-5/2,3MM RD - Test plug

3038723

<https://www.phoenixcontact.com/us/products/3038723>



Test plug, number of positions: 1, color: red

# STTB 2,5/2P SO - Double-level terminal block

3040892

<https://www.phoenixcontact.com/us/products/3040892>



## CLIPFIX 35 - End bracket

3022218

<https://www.phoenixcontact.com/us/products/3022218>



Quick mounting end clamp for NS 35/7,5 DIN rail or NS 35/15 DIN rail, with marking option, width: 9.5 mm, color: gray

---

## CLIPFIX 35-5 - End bracket

3022276

<https://www.phoenixcontact.com/us/products/3022276>



Quick mounting end clamp for NS 35/7,5 DIN rail or NS 35/15 DIN rail, with marking option, with parking option for FBS...5, FBS...6, KSS 5, KSS 6, width: 5.15 mm, color: gray



# STTB 2,5/2P SO - Double-level terminal block

3040892

<https://www.phoenixcontact.com/us/products/3040892>



## E/NS 35 N - End bracket

0800886

<https://www.phoenixcontact.com/us/products/0800886>

End clamp, width: 9.5 mm, color: gray

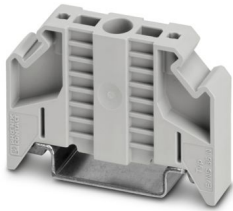

---

## SP 2,5/ 1 - Plug

3040258

<https://www.phoenixcontact.com/us/products/3040258>

Plug, nom. voltage: 500 V, nominal current: 24 A, number of positions: 1, connection method: Spring-cage connection, Rated cross section: 2.5 mm<sup>2</sup>, cross section: 0.08 mm<sup>2</sup> - 4 mm<sup>2</sup>, color: gray



# STTB 2,5/2P SO - Double-level terminal block

3040892

<https://www.phoenixcontact.com/us/products/3040892>

## SP 2,5/ 2 - Plug

3040261

<https://www.phoenixcontact.com/us/products/3040261>



Plug, nom. voltage: 500 V, nominal current: 24 A, number of positions: 2, connection method: Spring-cage connection, Rated cross section: 2.5 mm<sup>2</sup>, cross section: 0.08 mm<sup>2</sup>- 4 mm<sup>2</sup>, color: gray

---

## SP 2,5/ 3 - Plug

3040274

<https://www.phoenixcontact.com/us/products/3040274>



Plug, nom. voltage: 500 V, nominal current: 24 A, number of positions: 3, connection method: Spring-cage connection, Rated cross section: 2.5 mm<sup>2</sup>, cross section: 0.08 mm<sup>2</sup>- 4 mm<sup>2</sup>, color: gray

# STTB 2,5/2P SO - Double-level terminal block

3040892

<https://www.phoenixcontact.com/us/products/3040892>

## SP 2,5/ 4 - Plug

3040287

<https://www.phoenixcontact.com/us/products/3040287>



Plug, nom. voltage: 500 V, nominal current: 24 A, number of positions: 4, connection method: Spring-cage connection, Rated cross section: 2.5 mm<sup>2</sup>, cross section: 0.08 mm<sup>2</sup>- 4 mm<sup>2</sup>, color: gray

---

## SP 2,5/ 5 - Plug

3040290

<https://www.phoenixcontact.com/us/products/3040290>



Plug, nom. voltage: 500 V, nominal current: 24 A, number of positions: 5, connection method: Spring-cage connection, Rated cross section: 2.5 mm<sup>2</sup>, cross section: 0.08 mm<sup>2</sup>- 4 mm<sup>2</sup>, color: gray

# STTB 2,5/2P SO - Double-level terminal block

3040892

<https://www.phoenixcontact.com/us/products/3040892>

## SP 2,5/ 6 - Plug

3040300

<https://www.phoenixcontact.com/us/products/3040300>



Plug, nom. voltage: 500 V, nominal current: 24 A, number of positions: 6, connection method: Spring-cage connection, Rated cross section: 2.5 mm<sup>2</sup>, cross section: 0.08 mm<sup>2</sup>- 4 mm<sup>2</sup>, color: gray

---

## SP 2,5/ 7 - Plug

3040313

<https://www.phoenixcontact.com/us/products/3040313>



Plug, nom. voltage: 500 V, nominal current: 24 A, number of positions: 7, connection method: Spring-cage connection, Rated cross section: 2.5 mm<sup>2</sup>, cross section: 0.08 mm<sup>2</sup>- 4 mm<sup>2</sup>, color: gray

# STTB 2,5/2P SO - Double-level terminal block

3040892

<https://www.phoenixcontact.com/us/products/3040892>

## SP 2,5/ 8 - Plug

3040326

<https://www.phoenixcontact.com/us/products/3040326>



Plug, nom. voltage: 500 V, nominal current: 24 A, number of positions: 8, connection method: Spring-cage connection, Rated cross section: 2.5 mm<sup>2</sup>, cross section: 0.08 mm<sup>2</sup>- 4 mm<sup>2</sup>, color: gray

---

## SP 2,5/ 9 - Plug

3040339

<https://www.phoenixcontact.com/us/products/3040339>



Plug, nom. voltage: 500 V, nominal current: 24 A, number of positions: 9, connection method: Spring-cage connection, Rated cross section: 2.5 mm<sup>2</sup>, cross section: 0.08 mm<sup>2</sup>- 4 mm<sup>2</sup>, color: gray

# STTB 2,5/2P SO - Double-level terminal block

3040892

<https://www.phoenixcontact.com/us/products/3040892>

## SP 2,5/10 - Plug

3040342

<https://www.phoenixcontact.com/us/products/3040342>



Plug, nom. voltage: 500 V, nominal current: 24 A, number of positions: 10, connection method: Spring-cage connection, Rated cross section: 2.5 mm<sup>2</sup>, cross section: 0.08 mm<sup>2</sup>- 4 mm<sup>2</sup>, color: gray

---

## SP 2,5/11 - Plug

3040355

<https://www.phoenixcontact.com/us/products/3040355>



Plug, nom. voltage: 500 V, nominal current: 24 A, number of positions: 11, connection method: Spring-cage connection, Rated cross section: 2.5 mm<sup>2</sup>, cross section: 0.08 mm<sup>2</sup>- 4 mm<sup>2</sup>, color: gray

# STTB 2,5/2P SO - Double-level terminal block

3040892

<https://www.phoenixcontact.com/us/products/3040892>

## SP 2,5/12 - Plug

3040368

<https://www.phoenixcontact.com/us/products/3040368>



Plug, nom. voltage: 500 V, nominal current: 24 A, number of positions: 12, connection method: Spring-cage connection, Rated cross section: 2.5 mm<sup>2</sup>, cross section: 0.08 mm<sup>2</sup>- 4 mm<sup>2</sup>, color: gray

---

## SP 2,5/13 - Plug

3040371

<https://www.phoenixcontact.com/us/products/3040371>



Plug, nom. voltage: 500 V, nominal current: 24 A, number of positions: 13, connection method: Spring-cage connection, Rated cross section: 2.5 mm<sup>2</sup>, cross section: 0.08 mm<sup>2</sup>- 4 mm<sup>2</sup>, color: gray

# STTB 2,5/2P SO - Double-level terminal block



3040892

<https://www.phoenixcontact.com/us/products/3040892>

## SP 2,5/14 - Plug

3040384

<https://www.phoenixcontact.com/us/products/3040384>



Plug, nom. voltage: 500 V, nominal current: 24 A, number of positions: 14, connection method: Spring-cage connection, Rated cross section: 2.5 mm<sup>2</sup>, cross section: 0.08 mm<sup>2</sup>- 4 mm<sup>2</sup>, color: gray

---

## SP 2,5/15 - Plug

3040397

<https://www.phoenixcontact.com/us/products/3040397>



Plug, nom. voltage: 500 V, nominal current: 24 A, number of positions: 15, connection method: Spring-cage connection, Rated cross section: 2.5 mm<sup>2</sup>, cross section: 0.08 mm<sup>2</sup>- 4 mm<sup>2</sup>, color: gray



# STTB 2,5/2P SO - Double-level terminal block



3040892

<https://www.phoenixcontact.com/us/products/3040892>

## SP 2,5/ 1 BU - Plug

3040698

<https://www.phoenixcontact.com/us/products/3040698>



Plug, nom. voltage: 500 V, nominal current: 24 A, number of positions: 1, connection method: Spring-cage connection, Rated cross section: 2.5 mm<sup>2</sup>, cross section: 0.08 mm<sup>2</sup>- 4 mm<sup>2</sup>, color: blue

---

## SP 2,5/ 1 GNYE - Plug

3040708

<https://www.phoenixcontact.com/us/products/3040708>



Plug, nom. voltage: 500 V, nominal current: 24 A, number of positions: 1, connection method: Spring-cage connection, Rated cross section: 2.5 mm<sup>2</sup>, cross section: 0.08 mm<sup>2</sup>- 4 mm<sup>2</sup>, color: green-yellow

# STTB 2,5/2P SO - Double-level terminal block

3040892

<https://www.phoenixcontact.com/us/products/3040892>

## SPB 2,5/ 1 - Plug

3040106

<https://www.phoenixcontact.com/us/products/3040106>



Plug, nom. voltage: 500 V, nominal current: 24 A, number of positions: 1, connection method: Spring-cage connection, Rated cross section: 2.5 mm<sup>2</sup>, cross section: 0.08 mm<sup>2</sup>- 4 mm<sup>2</sup>, color: gray

---

## SPB 2,5/ 9 - Plug

3040180

<https://www.phoenixcontact.com/us/products/3040180>



Plug, nom. voltage: 500 V, nominal current: 24 A, number of positions: 9, connection method: Spring-cage connection, Rated cross section: 2.5 mm<sup>2</sup>, cross section: 0.08 mm<sup>2</sup>- 4 mm<sup>2</sup>, color: gray

# STTB 2,5/2P SO - Double-level terminal block

3040892

<https://www.phoenixcontact.com/us/products/3040892>

## SPB 2,5/11 - Plug

3040203

<https://www.phoenixcontact.com/us/products/3040203>



Plug, nom. voltage: 500 V, nominal current: 24 A, number of positions: 11, connection method: Spring-cage connection, Rated cross section: 2.5 mm<sup>2</sup>, cross section: 0.08 mm<sup>2</sup>- 4 mm<sup>2</sup>, color: gray

---

## SPB 2,5/13 - Plug

3040229

<https://www.phoenixcontact.com/us/products/3040229>



Plug, nom. voltage: 500 V, nominal current: 24 A, number of positions: 13, connection method: Spring-cage connection, Rated cross section: 2.5 mm<sup>2</sup>, cross section: 0.08 mm<sup>2</sup>- 4 mm<sup>2</sup>, color: gray

# STTB 2,5/2P SO - Double-level terminal block

3040892

<https://www.phoenixcontact.com/us/products/3040892>

## SPB 2,5/14 - Plug

3040232

<https://www.phoenixcontact.com/us/products/3040232>



Plug, nom. voltage: 500 V, nominal current: 24 A, number of positions: 14, connection method: Spring-cage connection, Rated cross section: 2.5 mm<sup>2</sup>, cross section: 0.08 mm<sup>2</sup>- 4 mm<sup>2</sup>, color: gray

---

## SPB 2,5/ 1 BU - Plug

3040724

<https://www.phoenixcontact.com/us/products/3040724>



Plug, nom. voltage: 500 V, nominal current: 24 A, number of positions: 1, connection method: Spring-cage connection, Rated cross section: 2.5 mm<sup>2</sup>, cross section: 0.08 mm<sup>2</sup>- 4 mm<sup>2</sup>, color: blue

# STTB 2,5/2P SO - Double-level terminal block

3040892

<https://www.phoenixcontact.com/us/products/3040892>

## SPB 2,5/ 1 GNYE - Plug

3040711

<https://www.phoenixcontact.com/us/products/3040711>



Plug, nom. voltage: 500 V, nominal current: 24 A, number of positions: 1, connection method: Spring-cage connection, Rated cross section: 2.5 mm<sup>2</sup>, cross section: 0.08 mm<sup>2</sup>- 4 mm<sup>2</sup>, color: green-yellow

---

## SPDB 2,5/ 1 - Plug

3040407

<https://www.phoenixcontact.com/us/products/3040407>



Plug, nom. voltage: 500 V, nominal current: 24 A, number of positions: 1, connection method: Spring-cage connection, Rated cross section: 2.5 mm<sup>2</sup>, cross section: 0.08 mm<sup>2</sup>- 4 mm<sup>2</sup>, color: gray

# STTB 2,5/2P SO - Double-level terminal block

3040892

<https://www.phoenixcontact.com/us/products/3040892>

## SPDB 2,5/ 9 - Plug

3040481

<https://www.phoenixcontact.com/us/products/3040481>



Plug, nom. voltage: 500 V, nominal current: 24 A, number of positions: 9, connection method: Spring-cage connection, Rated cross section: 2.5 mm<sup>2</sup>, cross section: 0.08 mm<sup>2</sup>- 4 mm<sup>2</sup>, color: gray

---

## SPDB 2,5/12 - Plug

3040517

<https://www.phoenixcontact.com/us/products/3040517>



Plug, nom. voltage: 500 V, nominal current: 24 A, number of positions: 12, connection method: Spring-cage connection, Rated cross section: 2.5 mm<sup>2</sup>, cross section: 0.08 mm<sup>2</sup>- 4 mm<sup>2</sup>, color: gray

# STTB 2,5/2P SO - Double-level terminal block

3040892

<https://www.phoenixcontact.com/us/products/3040892>

## SPDB 2,5/13 - Plug

3040520

<https://www.phoenixcontact.com/us/products/3040520>



Plug, nom. voltage: 500 V, nominal current: 24 A, number of positions: 13, connection method: Spring-cage connection, Rated cross section: 2.5 mm<sup>2</sup>, cross section: 0.08 mm<sup>2</sup>- 4 mm<sup>2</sup>, color: gray

---

## SPDB 2,5/14 - Plug

3040533

<https://www.phoenixcontact.com/us/products/3040533>



Plug, nom. voltage: 500 V, nominal current: 24 A, number of positions: 14, connection method: Spring-cage connection, Rated cross section: 2.5 mm<sup>2</sup>, cross section: 0.08 mm<sup>2</sup>- 4 mm<sup>2</sup>, color: gray

# STTB 2,5/2P SO - Double-level terminal block

3040892

<https://www.phoenixcontact.com/us/products/3040892>

## SPDB 2,5/ 1 BU - Plug

3040737

<https://www.phoenixcontact.com/us/products/3040737>



Plug, nom. voltage: 500 V, nominal current: 24 A, number of positions: 1, connection method: Spring-cage connection, Rated cross section: 2.5 mm<sup>2</sup>, cross section: 0.08 mm<sup>2</sup>- 4 mm<sup>2</sup>, color: blue

---

## SPDB 2,5/ 1 GNYE - Plug

3040740

<https://www.phoenixcontact.com/us/products/3040740>



Plug, nom. voltage: 500 V, nominal current: 24 A, number of positions: 1, connection method: Spring-cage connection, Rated cross section: 2.5 mm<sup>2</sup>, cross section: 0.08 mm<sup>2</sup>- 4 mm<sup>2</sup>, color: green-yellow



# STTB 2,5/2P SO - Double-level terminal block

3040892

<https://www.phoenixcontact.com/us/products/3040892>

## SP-H 2,5/ 1 - Plug

3210619

<https://www.phoenixcontact.com/us/products/3210619>



Plug, nom. voltage: 500 V, nominal current: 24 A, number of positions: 1, connection method: Spring-cage connection, Rated cross section: 2.5 mm<sup>2</sup>, cross section: 0.08 mm<sup>2</sup>- 4 mm<sup>2</sup>, color: gray

---

## SP-H 2,5/ 2 - Plug

3210622

<https://www.phoenixcontact.com/us/products/3210622>



Plug, nom. voltage: 500 V, nominal current: 24 A, number of positions: 2, connection method: Spring-cage connection, Rated cross section: 2.5 mm<sup>2</sup>, cross section: 0.08 mm<sup>2</sup>- 4 mm<sup>2</sup>, color: gray

# STTB 2,5/2P SO - Double-level terminal block

3040892

<https://www.phoenixcontact.com/us/products/3040892>

## SP-H 2,5/ 3 - Plug

3210635

<https://www.phoenixcontact.com/us/products/3210635>



Plug, nom. voltage: 500 V, nominal current: 24 A, number of positions: 3, connection method: Spring-cage connection, Rated cross section: 2.5 mm<sup>2</sup>, cross section: 0.08 mm<sup>2</sup>- 4 mm<sup>2</sup>, color: gray

---

## SP-H 2,5/ 4 - Plug

3210648

<https://www.phoenixcontact.com/us/products/3210648>



Plug, nom. voltage: 500 V, nominal current: 24 A, number of positions: 4, connection method: Spring-cage connection, Rated cross section: 2.5 mm<sup>2</sup>, cross section: 0.08 mm<sup>2</sup>- 4 mm<sup>2</sup>, color: gray

# STTB 2,5/2P SO - Double-level terminal block

3040892

<https://www.phoenixcontact.com/us/products/3040892>

## SP-H 2,5/ 5 - Plug

3210651

<https://www.phoenixcontact.com/us/products/3210651>



Plug, nom. voltage: 500 V, nominal current: 24 A, number of positions: 5, connection method: Spring-cage connection, Rated cross section: 2.5 mm<sup>2</sup>, cross section: 0.08 mm<sup>2</sup>- 4 mm<sup>2</sup>, color: gray

---

## SP-H 2,5/ 6 - Plug

3210664

<https://www.phoenixcontact.com/us/products/3210664>



Plug, nom. voltage: 500 V, nominal current: 24 A, number of positions: 6, connection method: Spring-cage connection, Rated cross section: 2.5 mm<sup>2</sup>, cross section: 0.08 mm<sup>2</sup>- 4 mm<sup>2</sup>, color: gray

# STTB 2,5/2P SO - Double-level terminal block

3040892

<https://www.phoenixcontact.com/us/products/3040892>

## SP-H 2,5/ 7 - Plug

3210677

<https://www.phoenixcontact.com/us/products/3210677>



Plug, nom. voltage: 500 V, nominal current: 24 A, number of positions: 7, connection method: Spring-cage connection, Rated cross section: 2.5 mm<sup>2</sup>, cross section: 0.08 mm<sup>2</sup>- 4 mm<sup>2</sup>, color: gray

---

## SP-H 2,5/ 8 - Plug

3210680

<https://www.phoenixcontact.com/us/products/3210680>



Plug, nom. voltage: 500 V, nominal current: 24 A, number of positions: 8, connection method: Spring-cage connection, Rated cross section: 2.5 mm<sup>2</sup>, cross section: 0.08 mm<sup>2</sup>- 4 mm<sup>2</sup>, color: gray

# STTB 2,5/2P SO - Double-level terminal block

3040892

<https://www.phoenixcontact.com/us/products/3040892>

## SP-H 2,5/ 9 - Plug

3210693

<https://www.phoenixcontact.com/us/products/3210693>



Plug, nom. voltage: 500 V, nominal current: 24 A, number of positions: 9, connection method: Spring-cage connection, Rated cross section: 2.5 mm<sup>2</sup>, cross section: 0.08 mm<sup>2</sup>- 4 mm<sup>2</sup>, color: gray

---

## SP-H 2,5/10 - Plug

3210703

<https://www.phoenixcontact.com/us/products/3210703>



Plug, nom. voltage: 500 V, nominal current: 24 A, number of positions: 10, connection method: Spring-cage connection, Rated cross section: 2.5 mm<sup>2</sup>, cross section: 0.08 mm<sup>2</sup>- 4 mm<sup>2</sup>, color: gray

# STTB 2,5/2P SO - Double-level terminal block



3040892

<https://www.phoenixcontact.com/us/products/3040892>

## SP-H 2,5/11 - Plug

3210716

<https://www.phoenixcontact.com/us/products/3210716>



Plug, nom. voltage: 500 V, nominal current: 24 A, number of positions: 11, connection method: Spring-cage connection, Rated cross section: 2.5 mm<sup>2</sup>, cross section: 0.08 mm<sup>2</sup>- 4 mm<sup>2</sup>, color: gray

---

## SP-H 2,5/12 - Plug

3210729

<https://www.phoenixcontact.com/us/products/3210729>



Plug, nom. voltage: 500 V, nominal current: 24 A, number of positions: 12, connection method: Spring-cage connection, Rated cross section: 2.5 mm<sup>2</sup>, cross section: 0.08 mm<sup>2</sup>- 4 mm<sup>2</sup>, color: gray

# STTB 2,5/2P SO - Double-level terminal block

3040892

<https://www.phoenixcontact.com/us/products/3040892>

## SP-H 2,5/13 - Plug

3210732

<https://www.phoenixcontact.com/us/products/3210732>



Plug, nom. voltage: 500 V, nominal current: 24 A, number of positions: 13, connection method: Spring-cage connection, Rated cross section: 2.5 mm<sup>2</sup>, cross section: 0.08 mm<sup>2</sup>- 4 mm<sup>2</sup>, color: gray

---

## SP-H 2,5/15 - Plug

3210758

<https://www.phoenixcontact.com/us/products/3210758>



Plug, nom. voltage: 500 V, nominal current: 24 A, number of positions: 15, connection method: Spring-cage connection, Rated cross section: 2.5 mm<sup>2</sup>, cross section: 0.08 mm<sup>2</sup>- 4 mm<sup>2</sup>, color: gray

# STTB 2,5/2P SO - Double-level terminal block



3040892

<https://www.phoenixcontact.com/us/products/3040892>

## SP-H 2,5/ 1 BU - Plug

3210761

<https://www.phoenixcontact.com/us/products/3210761>



Plug, nom. voltage: 500 V, nominal current: 24 A, number of positions: 1, connection method: Spring-cage connection, Rated cross section: 2.5 mm<sup>2</sup>, cross section: 0.08 mm<sup>2</sup>- 4 mm<sup>2</sup>, color: blue

---

## SP-H 2,5/ 1 GNYE - Plug

3210774

<https://www.phoenixcontact.com/us/products/3210774>



Plug, nom. voltage: 500 V, nominal current: 24 A, number of positions: 1, connection method: Spring-cage connection, Rated cross section: 2.5 mm<sup>2</sup>, cross section: 0.08 mm<sup>2</sup>- 4 mm<sup>2</sup>, color: green-yellow



# STTB 2,5/2P SO - Double-level terminal block

3040892

<https://www.phoenixcontact.com/us/products/3040892>

## SP-H 2,5/ 1-L - Plug

3210787

<https://www.phoenixcontact.com/us/products/3210787>



Plug, nom. voltage: 500 V, nominal current: 24 A, number of positions: 1, connection method: Spring-cage connection, Rated cross section: 2.5 mm<sup>2</sup>, cross section: 0.08 mm<sup>2</sup>- 4 mm<sup>2</sup>, color: gray

---

## SP-H 2,5/ 1-L BU - Plug

3210790

<https://www.phoenixcontact.com/us/products/3210790>



Plug, nom. voltage: 500 V, nominal current: 24 A, number of positions: 1, connection method: Spring-cage connection, Rated cross section: 2.5 mm<sup>2</sup>, cross section: 0.08 mm<sup>2</sup>- 4 mm<sup>2</sup>, color: blue

# STTB 2,5/2P SO - Double-level terminal block

3040892

<https://www.phoenixcontact.com/us/products/3040892>

## SP-H 2,5/ 1-L GNYE - Plug

3210800

<https://www.phoenixcontact.com/us/products/3210800>



Plug, nom. voltage: 500 V, nominal current: 24 A, number of positions: 1, connection method: Spring-cage connection, Rated cross section: 2.5 mm<sup>2</sup>, cross section: 0.08 mm<sup>2</sup>- 4 mm<sup>2</sup>, color: green-yellow

---

## SP-H 2,5/ 1-M - Plug

3210813

<https://www.phoenixcontact.com/us/products/3210813>



Plug, nom. voltage: 500 V, nominal current: 24 A, number of positions: 1, connection method: Spring-cage connection, Rated cross section: 2.5 mm<sup>2</sup>, cross section: 0.08 mm<sup>2</sup>- 4 mm<sup>2</sup>, color: gray

# STTB 2,5/2P SO - Double-level terminal block



3040892

<https://www.phoenixcontact.com/us/products/3040892>

## SP-H 2,5/ 1-M BU - Plug

3210826

<https://www.phoenixcontact.com/us/products/3210826>



Plug, nom. voltage: 500 V, nominal current: 24 A, number of positions: 1, connection method: Spring-cage connection, Rated cross section: 2.5 mm<sup>2</sup>, cross section: 0.08 mm<sup>2</sup>- 4 mm<sup>2</sup>, color: blue

---

## SP-H 2,5/ 1-M GNYE - Plug

3210839

<https://www.phoenixcontact.com/us/products/3210839>



Plug, nom. voltage: 500 V, nominal current: 24 A, number of positions: 1, connection method: Spring-cage connection, Rated cross section: 2.5 mm<sup>2</sup>, cross section: 0.08 mm<sup>2</sup>- 4 mm<sup>2</sup>, color: green-yellow

# STTB 2,5/2P SO - Double-level terminal block

3040892

<https://www.phoenixcontact.com/us/products/3040892>

## SP-H 2,5/ 1-R - Plug

3210842

<https://www.phoenixcontact.com/us/products/3210842>



Plug, nom. voltage: 500 V, nominal current: 24 A, number of positions: 1, connection method: Spring-cage connection, Rated cross section: 2.5 mm<sup>2</sup>, cross section: 0.08 mm<sup>2</sup>- 4 mm<sup>2</sup>, color: gray

---

## SP-H 2,5/ 1-R BU - Plug

3210855

<https://www.phoenixcontact.com/us/products/3210855>



Plug, nom. voltage: 500 V, nominal current: 24 A, number of positions: 1, connection method: Spring-cage connection, Rated cross section: 2.5 mm<sup>2</sup>, cross section: 0.08 mm<sup>2</sup>- 4 mm<sup>2</sup>, color: blue

# STTB 2,5/2P SO - Double-level terminal block

3040892

<https://www.phoenixcontact.com/us/products/3040892>

## SP-H 2,5/ 1-R GNYE - Plug

3210868

<https://www.phoenixcontact.com/us/products/3210868>



Plug, nom. voltage: 500 V, nominal current: 24 A, number of positions: 1, connection method: Spring-cage connection, Rated cross section: 2.5 mm<sup>2</sup>, cross section: 0.08 mm<sup>2</sup>- 4 mm<sup>2</sup>, color: green-yellow

---

## SPV 2,5/ 1 - Plug

3041710

<https://www.phoenixcontact.com/us/products/3041710>



Plug, nom. voltage: 500 V, nominal current: 24 A, number of positions: 1, connection method: Spring-cage connection, Rated cross section: 2.5 mm<sup>2</sup>, cross section: 0.08 mm<sup>2</sup>- 4 mm<sup>2</sup>, color: gray

# STTB 2,5/2P SO - Double-level terminal block

3040892

<https://www.phoenixcontact.com/us/products/3040892>

## SPV 2,5/ 6 - Plug

3041765

<https://www.phoenixcontact.com/us/products/3041765>



Plug, nom. voltage: 500 V, nominal current: 24 A, number of positions: 6, connection method: Spring-cage connection, Rated cross section: 2.5 mm<sup>2</sup>, cross section: 0.08 mm<sup>2</sup>- 4 mm<sup>2</sup>, color: gray

---

## SPV 2,5/ 9 - Plug

3041794

<https://www.phoenixcontact.com/us/products/3041794>



Plug, nom. voltage: 500 V, nominal current: 24 A, number of positions: 9, connection method: Spring-cage connection, Rated cross section: 2.5 mm<sup>2</sup>, cross section: 0.08 mm<sup>2</sup>- 4 mm<sup>2</sup>, color: gray

# STTB 2,5/2P SO - Double-level terminal block

3040892

<https://www.phoenixcontact.com/us/products/3040892>

## SPV 2,5/11 - Plug

3041817

<https://www.phoenixcontact.com/us/products/3041817>



Plug, nom. voltage: 500 V, nominal current: 24 A, number of positions: 11, connection method: Spring-cage connection, Rated cross section: 2.5 mm<sup>2</sup>, cross section: 0.08 mm<sup>2</sup>- 4 mm<sup>2</sup>, color: gray

---

## SPV 2,5/12 - Plug

3041820

<https://www.phoenixcontact.com/us/products/3041820>



Plug, nom. voltage: 500 V, nominal current: 24 A, number of positions: 12, connection method: Spring-cage connection, Rated cross section: 2.5 mm<sup>2</sup>, cross section: 0.08 mm<sup>2</sup>- 4 mm<sup>2</sup>, color: gray

# STTB 2,5/2P SO - Double-level terminal block

3040892

<https://www.phoenixcontact.com/us/products/3040892>

## SPV 2,5/13 - Plug

3041833

<https://www.phoenixcontact.com/us/products/3041833>



Plug, nom. voltage: 500 V, nominal current: 24 A, number of positions: 13, connection method: Spring-cage connection, Rated cross section: 2.5 mm<sup>2</sup>, cross section: 0.08 mm<sup>2</sup>- 4 mm<sup>2</sup>, color: gray

---

## SPV 2,5/14 - Plug

3041846

<https://www.phoenixcontact.com/us/products/3041846>



Plug, nom. voltage: 500 V, nominal current: 24 A, number of positions: 14, connection method: Spring-cage connection, Rated cross section: 2.5 mm<sup>2</sup>, cross section: 0.08 mm<sup>2</sup>- 4 mm<sup>2</sup>, color: gray



# STTB 2,5/2P SO - Double-level terminal block

3040892

<https://www.phoenixcontact.com/us/products/3040892>

## SPV 2,5/15 - Plug

3041859

<https://www.phoenixcontact.com/us/products/3041859>



Plug, nom. voltage: 500 V, nominal current: 24 A, number of positions: 15, connection method: Spring-cage connection, Rated cross section: 2.5 mm<sup>2</sup>, cross section: 0.08 mm<sup>2</sup>- 4 mm<sup>2</sup>, color: gray

---

## SPV 2,5/ 1 BU - Plug

3061017

<https://www.phoenixcontact.com/us/products/3061017>



Plug, nom. voltage: 500 V, nominal current: 24 A, number of positions: 1, connection method: Spring-cage connection, Rated cross section: 2.5 mm<sup>2</sup>, cross section: 0.08 mm<sup>2</sup>- 4 mm<sup>2</sup>, color: blue

# STTB 2,5/2P SO - Double-level terminal block

3040892

<https://www.phoenixcontact.com/us/products/3040892>

## SPV 2,5/ 1 GNYE - Plug

3061020

<https://www.phoenixcontact.com/us/products/3061020>



Plug, nom. voltage: 500 V, nominal current: 24 A, number of positions: 1, connection method: Spring-cage connection, Rated cross section: 2.5 mm<sup>2</sup>, cross section: 0.08 mm<sup>2</sup>- 4 mm<sup>2</sup>, color: green-yellow

---

## SPV 2,5/ 1-L - Plug

3041024

<https://www.phoenixcontact.com/us/products/3041024>



Plug, nom. voltage: 500 V, nominal current: 24 A, number of positions: 1, connection method: Spring-cage connection, Rated cross section: 2.5 mm<sup>2</sup>, cross section: 0.08 mm<sup>2</sup>- 4 mm<sup>2</sup>, color: gray

# STTB 2,5/2P SO - Double-level terminal block

3040892

<https://www.phoenixcontact.com/us/products/3040892>

## SPV 2,5/ 1-L BU - Plug

3041037

<https://www.phoenixcontact.com/us/products/3041037>



Plug, nom. voltage: 500 V, nominal current: 24 A, number of positions: 1, connection method: Spring-cage connection, Rated cross section: 2.5 mm<sup>2</sup>, cross section: 0.08 mm<sup>2</sup>- 4 mm<sup>2</sup>, color: blue

---

## SPV 2,5/ 1-L GNYE - Plug

3041040

<https://www.phoenixcontact.com/us/products/3041040>



Plug, nom. voltage: 500 V, nominal current: 24 A, number of positions: 1, connection method: Spring-cage connection, Rated cross section: 2.5 mm<sup>2</sup>, cross section: 0.08 mm<sup>2</sup>- 4 mm<sup>2</sup>, color: green-yellow

# STTB 2,5/2P SO - Double-level terminal block

3040892

<https://www.phoenixcontact.com/us/products/3040892>

## SPV 2,5/ 1-M - Plug

3041053

<https://www.phoenixcontact.com/us/products/3041053>



Plug, nom. voltage: 500 V, nominal current: 24 A, number of positions: 1, connection method: Spring-cage connection, Rated cross section: 2.5 mm<sup>2</sup>, cross section: 0.08 mm<sup>2</sup>- 4 mm<sup>2</sup>, color: gray

---

## SPV 2,5/ 1-M BU - Plug

3041066

<https://www.phoenixcontact.com/us/products/3041066>



Plug, nom. voltage: 500 V, nominal current: 24 A, number of positions: 1, connection method: Spring-cage connection, Rated cross section: 2.5 mm<sup>2</sup>, cross section: 0.08 mm<sup>2</sup>- 4 mm<sup>2</sup>, color: blue

# STTB 2,5/2P SO - Double-level terminal block

3040892

<https://www.phoenixcontact.com/us/products/3040892>

## SPV 2,5/ 1-M GNYE - Plug

3041079

<https://www.phoenixcontact.com/us/products/3041079>



Plug, nom. voltage: 500 V, nominal current: 24 A, number of positions: 1, connection method: Spring-cage connection, Rated cross section: 2.5 mm<sup>2</sup>, cross section: 0.08 mm<sup>2</sup>- 4 mm<sup>2</sup>, color: green-yellow

---

## SPV 2,5/ 1-R - Plug

3041082

<https://www.phoenixcontact.com/us/products/3041082>



Plug, nom. voltage: 500 V, nominal current: 24 A, number of positions: 1, connection method: Spring-cage connection, Rated cross section: 2.5 mm<sup>2</sup>, cross section: 0.08 mm<sup>2</sup>- 4 mm<sup>2</sup>, color: gray

# STTB 2,5/2P SO - Double-level terminal block

3040892

<https://www.phoenixcontact.com/us/products/3040892>

## SPV 2,5/ 1-R BU - Plug

3041095

<https://www.phoenixcontact.com/us/products/3041095>



Plug, nom. voltage: 500 V, nominal current: 24 A, number of positions: 1, connection method: Spring-cage connection, Rated cross section: 2.5 mm<sup>2</sup>, cross section: 0.08 mm<sup>2</sup>- 4 mm<sup>2</sup>, color: blue

---

## SPV 2,5/ 1-R GNYE - Plug

3041105

<https://www.phoenixcontact.com/us/products/3041105>



Plug, nom. voltage: 500 V, nominal current: 24 A, number of positions: 1, connection method: Spring-cage connection, Rated cross section: 2.5 mm<sup>2</sup>, cross section: 0.08 mm<sup>2</sup>- 4 mm<sup>2</sup>, color: green-yellow

## STTB 2,5/2P SO - Double-level terminal block

3040892

<https://www.phoenixcontact.com/us/products/3040892>



## SZF 1-0,6X3,5 - Screwdriver

1204517

<https://www.phoenixcontact.com/us/products/1204517>



Actuation tool, for ST terminal blocks, also suitable for use as a bladed screwdriver, size: 0.6 x 3.5 x 100 mm, 2-component grip, with non-slip grip

---

## STTB 2,5/2P-F - Screw flange

3061169

<https://www.phoenixcontact.com/us/products/3061169>



Screw flange, for screwing COMBI plugs, with the same structure and pitch as the relevant COMBI terminal blocks

# STTB 2,5/2P SO - Double-level terminal block

3040892

<https://www.phoenixcontact.com/us/products/3040892>



## STTB 2,5/2P-FS - Latching flange

3061428

<https://www.phoenixcontact.com/us/products/3061428>

Latching flange, mounting type: NS 35/7,5, NS 35/15, color: gray



---

## ST-BW - Actuation tool

1207608

<https://www.phoenixcontact.com/us/products/1207608>

Actuation tool, for all 2.5 mm<sup>2</sup> - 4.0 mm<sup>2</sup> spring-cages



---

Phoenix Contact 2024 © - all rights reserved  
<https://www.phoenixcontact.com>

Phoenix Contact USA  
586 Fulling Mill Road  
Middletown, PA 17057, United States  
(+717) 944-1300  
[info@phoenixcon.com](mailto:info@phoenixcon.com)