

# MUN2130, MMUN2130L, MUN5130, DTA113EE, DTA113EM3, NSBA113EF3

## Digital Transistors (BRT) R1 = 1 kΩ, R2 = 1 kΩ

### PNP Transistors with Monolithic Bias Resistor Network

This series of digital transistors is designed to replace a single device and its external resistor bias network. The Bias Resistor Transistor (BRT) contains a single transistor with a monolithic bias network consisting of two resistors; a series base resistor and a base-emitter resistor. The BRT eliminates these individual components by integrating them into a single device. The use of a BRT can reduce both system cost and board space.

#### Features

- Simplifies Circuit Design
- Reduces Board Space
- Reduces Component Count
- S and NSV Prefix for Automotive and Other Applications Requiring Unique Site and Control Change Requirements; AEC-Q101 Qualified and PPAP Capable
- These Devices are Pb-Free, Halogen Free/BFR Free and are RoHS Compliant

#### MAXIMUM RATINGS (T<sub>A</sub> = 25°C)

Rating	Symbol	Max	Unit
Collector-Base Voltage	V <sub>CBO</sub>	50	Vdc
Collector-Emitter Voltage	V <sub>CEO</sub>	50	Vdc
Collector Current - Continuous	I <sub>C</sub>	100	mAdc
Input Forward Voltage	V <sub>IN(fwd)</sub>	10	Vdc
Input Reverse Voltage	V <sub>IN(rev)</sub>	10	Vdc

Stresses exceeding those listed in the Maximum Ratings table may damage the device. If any of these limits are exceeded, device functionality should not be assumed, damage may occur and reliability may be affected.



ON Semiconductor®

[www.onsemi.com](http://www.onsemi.com)

#### PIN CONNECTIONS

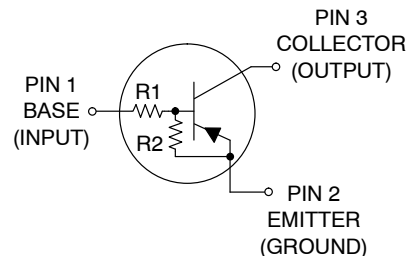

#### MARKING DIAGRAMS

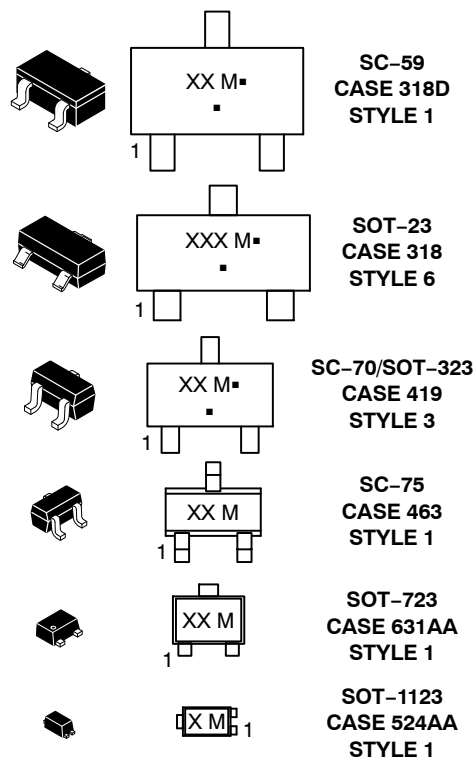

XXX = Specific Device Code  
M = Date Code\*  
■ = Pb-Free Package

(Note: Microdot may be in either location)

\*Date Code orientation may vary depending upon manufacturing location.

#### ORDERING INFORMATION

See detailed ordering, marking, and shipping information on page 2 of this data sheet.

# MUN2130, MMUN2130L, MUN5130, DTA113EE, DTA113EM3, NSBA113EF3

**Table 1. ORDERING INFORMATION**

Device	Part Marking	Package	Shipping†
MUN2130T1G	6G	SC-59 (Pb-Free)	3000 / Tape & Reel
MMUN2130LT1G	A6G	SOT-23 (Pb-Free)	3000 / Tape & Reel
MUN5130T1G	6G	SC-70/SOT-323 (Pb-Free)	3000 / Tape & Reel
DTA113EET1G	6G	SC-75 (Pb-Free)	3000 / Tape & Reel
DTA113EM3T5G, NSVDTA113EM3T5G*	7E	SOT-723 (Pb-Free)	8000 / Tape & Reel
NSBA113EF3T5G	L (180°)**	SOT-1123 (Pb-Free)	8000 / Tape & Reel

†For information on tape and reel specifications, including part orientation and tape sizes, please refer to our Tape and Reel Packaging Specifications Brochure, BRD8011/D.

\*\* (xx°) = Degree rotation in the clockwise direction.

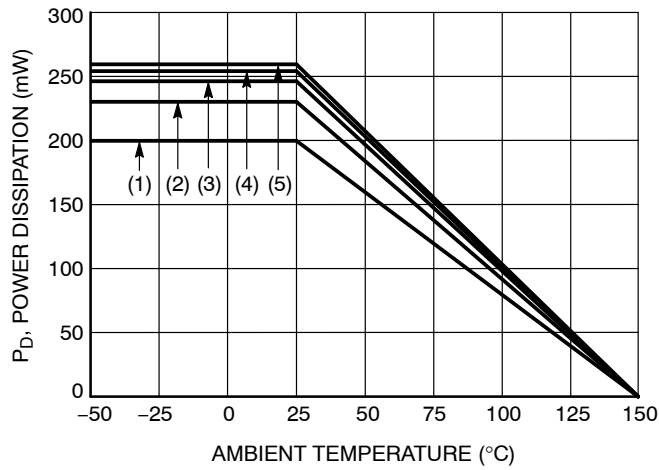

- (1) SC-75 and SC-70/SOT323; Minimum Pad
- (2) SC-59; Minimum Pad
- (3) SOT-23; Minimum Pad
- (4) SOT-1123; 100 mm<sup>2</sup>, 1 oz. copper trace
- (5) SOT-723; Minimum Pad

**Figure 1. Derating Curve**

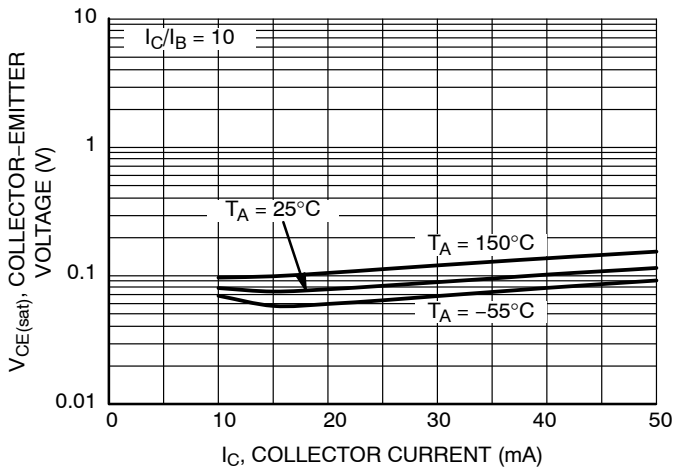

Figure 2.  $V_{CE(sat)}$  vs.  $I_C$

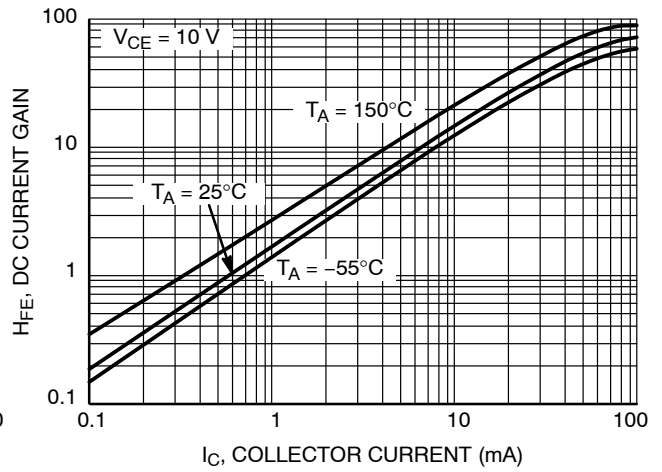

Figure 3. DC Current Gain

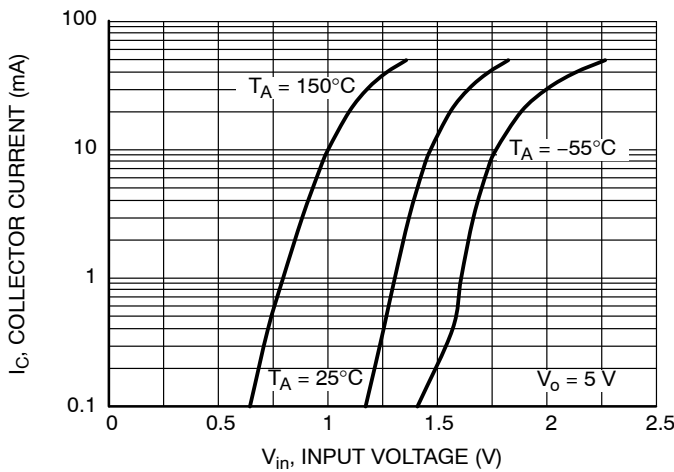

Figure 4. Output Current vs. Input Voltage

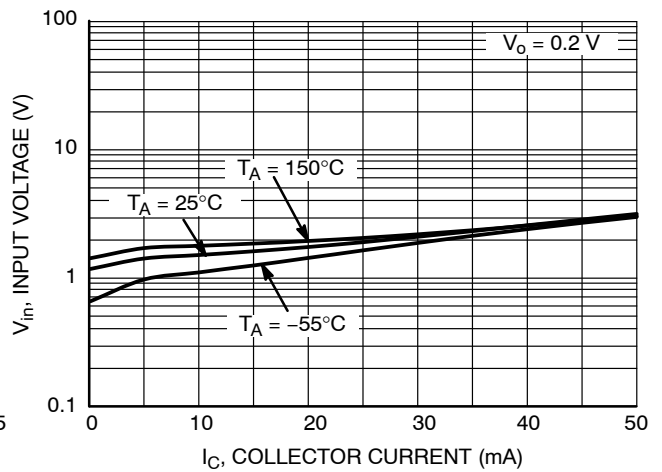

Figure 5. Input Voltage vs. Output Current

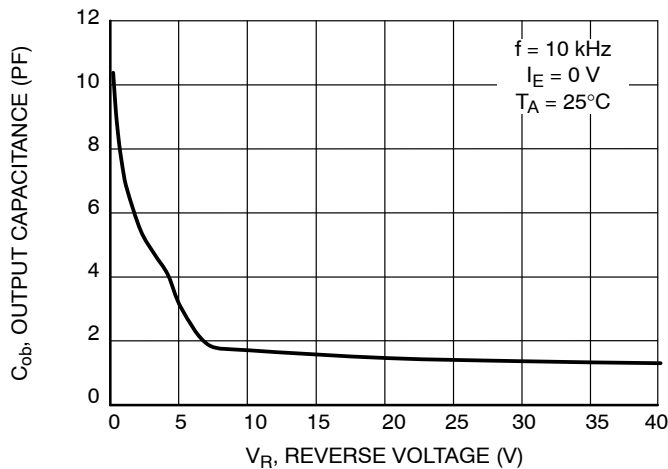

Figure 6. Output Capacitance

# MUN2130, MMUN2130L, MUN5130, DTA113EE, DTA113EM3, NSBA113EF3

**Table 2. THERMAL CHARACTERISTICS**

Characteristic	Symbol	Max	Unit
<b>THERMAL CHARACTERISTICS (SC-59) (MUN2130)</b>			
Total Device Dissipation $T_A = 25^\circ\text{C}$ Derate above $25^\circ\text{C}$	(Note 1) (Note 2) (Note 1) (Note 2)	$P_D$ 230 338 1.8 2.7	mW mW/ $^\circ\text{C}$
Thermal Resistance, Junction to Ambient	(Note 1) (Note 2)	$R_{\theta JA}$ 540 370	$^\circ\text{C}/\text{W}$
Thermal Resistance, Junction to Lead	(Note 1) (Note 2)	$R_{\theta JL}$ 264 287	$^\circ\text{C}/\text{W}$
Junction and Storage Temperature Range	$T_J, T_{stg}$	-55 to +150	$^\circ\text{C}$
<b>THERMAL CHARACTERISTICS (SOT-23) (MMUN2130L)</b>			
Total Device Dissipation $T_A = 25^\circ\text{C}$ Derate above $25^\circ\text{C}$	(Note 1) (Note 2) (Note 1) (Note 2)	$P_D$ 246 400 2.0 3.2	mW mW/ $^\circ\text{C}$
Thermal Resistance, Junction to Ambient	(Note 1) (Note 2)	$R_{\theta JA}$ 508 311	$^\circ\text{C}/\text{W}$
Thermal Resistance, Junction to Lead	(Note 1) (Note 2)	$R_{\theta JL}$ 174 208	$^\circ\text{C}/\text{W}$
Junction and Storage Temperature Range	$T_J, T_{stg}$	-55 to +150	$^\circ\text{C}$
<b>THERMAL CHARACTERISTICS (SC-70/SOT-323) (MUN5130)</b>			
Total Device Dissipation $T_A = 25^\circ\text{C}$ Derate above $25^\circ\text{C}$	(Note 1) (Note 2) (Note 1) (Note 2)	$P_D$ 202 310 1.6 2.5	mW mW/ $^\circ\text{C}$
Thermal Resistance, Junction to Ambient	(Note 1) (Note 2)	$R_{\theta JA}$ 618 403	$^\circ\text{C}/\text{W}$
Thermal Resistance, Junction to Lead	(Note 1) (Note 2)	$R_{\theta JL}$ 280 332	$^\circ\text{C}/\text{W}$
Junction and Storage Temperature Range	$T_J, T_{stg}$	-55 to +150	$^\circ\text{C}$
<b>THERMAL CHARACTERISTICS (SC-75) (DTA113EE)</b>			
Total Device Dissipation $T_A = 25^\circ\text{C}$ Derate above $25^\circ\text{C}$	(Note 1) (Note 2) (Note 1) (Note 2)	$P_D$ 200 300 1.6 2.4	mW mW/ $^\circ\text{C}$
Thermal Resistance, Junction to Ambient	(Note 1) (Note 2)	$R_{\theta JA}$ 600 400	$^\circ\text{C}/\text{W}$
Junction and Storage Temperature Range	$T_J, T_{stg}$	-55 to +150	$^\circ\text{C}$
<b>THERMAL CHARACTERISTICS (SOT-723) (DTA113EM3)</b>			
Total Device Dissipation $T_A = 25^\circ\text{C}$ Derate above $25^\circ\text{C}$	(Note 1) (Note 2) (Note 1) (Note 2)	$P_D$ 260 600 2.0 4.8	mW mW/ $^\circ\text{C}$
Thermal Resistance, Junction to Ambient	(Note 1) (Note 2)	$R_{\theta JA}$ 480 205	$^\circ\text{C}/\text{W}$
Junction and Storage Temperature Range	$T_J, T_{stg}$	-55 to +150	$^\circ\text{C}$

- FR-4 @ Minimum Pad.
- FR-4 @ 1.0 x 1.0 Inch Pad.
- FR-4 @ 100 mm<sup>2</sup>, 1 oz. copper traces, still air.
- FR-4 @ 500 mm<sup>2</sup>, 1 oz. copper traces, still air.

# MUN2130, MMUN2130L, MUN5130, DTA113EE, DTA113EM3, NSBA113EF3

**Table 2. THERMAL CHARACTERISTICS**

Characteristic	Symbol	Max	Unit
<b>THERMAL CHARACTERISTICS (SOT-1123) (NSBA113EF3)</b>			
Total Device Dissipation $T_A = 25^\circ\text{C}$	$P_D$	254 297	mW
Derate above $25^\circ\text{C}$		2.0 2.4	mW/ $^\circ\text{C}$
Thermal Resistance, Junction to Ambient	$R_{\theta JA}$	493 421	$^\circ\text{C}/\text{W}$
Thermal Resistance, Junction to Lead	$R_{\theta JL}$	193	$^\circ\text{C}/\text{W}$
Junction and Storage Temperature Range	$T_J, T_{stg}$	-55 to +150	$^\circ\text{C}$

- FR-4 @ Minimum Pad.
- FR-4 @ 1.0 x 1.0 Inch Pad.
- FR-4 @ 100 mm<sup>2</sup>, 1 oz. copper traces, still air.
- FR-4 @ 500 mm<sup>2</sup>, 1 oz. copper traces, still air.

**Table 3. ELECTRICAL CHARACTERISTICS** ( $T_A = 25^\circ\text{C}$ , unless otherwise noted)

Characteristic	Symbol	Min	Typ	Max	Unit
<b>OFF CHARACTERISTICS</b>					
Collector-Base Cutoff Current ( $V_{CB} = 50\text{ V}, I_E = 0$ )	$I_{CBO}$	-	-	100	nAdc
Collector-Emitter Cutoff Current ( $V_{CE} = 50\text{ V}, I_B = 0$ )	$I_{CEO}$	-	-	500	nAdc
Emitter-Base Cutoff Current ( $V_{EB} = 6.0\text{ V}, I_C = 0$ )	$I_{EBO}$	-	-	4.3	mAdc
Collector-Base Breakdown Voltage ( $I_C = 10\ \mu\text{A}, I_E = 0$ )	$V_{(BR)CBO}$	50	-	-	Vdc
Collector-Emitter Breakdown Voltage (Note 5) ( $I_C = 2.0\text{ mA}, I_B = 0$ )	$V_{(BR)CEO}$	50	-	-	Vdc
<b>ON CHARACTERISTICS</b>					
DC Current Gain (Note 5) ( $I_C = 5.0\text{ mA}, V_{CE} = 10\text{ V}$ )	$h_{FE}$	3.0	5.0	-	
Collector-Emitter Saturation Voltage (Note 5) ( $I_C = 10\text{ mA}, I_B = 5.0\text{ mA}$ )	$V_{CE(sat)}$	-	-	0.25	Vdc
Input Voltage (off) ( $V_{CE} = 5.0\text{ V}, I_C = 100\ \mu\text{A}$ )	$V_{i(off)}$	-	1.2	0.5	Vdc
Input Voltage (on) ( $V_{CE} = 0.3\text{ V}, I_C = 20\text{ mA}$ )	$V_{i(on)}$	2.0	1.6	-	Vdc
Output Voltage (on) ( $V_{CC} = 5.0\text{ V}, V_B = 2.5\text{ V}, R_L = 1.0\text{ k}\Omega$ )	$V_{OL}$	-	-	0.2	Vdc
Output Voltage (off) ( $V_{CC} = 5.0\text{ V}, V_B = 0.05\text{ V}, R_L = 1.0\text{ k}\Omega$ )	$V_{OH}$	4.9	-	-	Vdc
Input Resistor	$R_1$	0.7	1.0	1.3	k $\Omega$
Resistor Ratio	$R_1/R_2$	0.8	1.0	1.2	

Product parametric performance is indicated in the Electrical Characteristics for the listed test conditions, unless otherwise noted. Product performance may not be indicated by the Electrical Characteristics if operated under different conditions.

- Pulsed Condition: Pulse Width = 300 msec, Duty Cycle  $\leq 2\%$ .

# MECHANICAL CASE OUTLINE

## PACKAGE DIMENSIONS



**SOT-23 (TO-236)**  
**CASE 318**  
**ISSUE AT**

DATE 01 MAR 2023

SCALE 4:1



**NOTES:**

1. DIMENSIONING AND TOLERANCING PER ASME Y14.5M,1994.
2. CONTROLLING DIMENSION: MILLIMETERS
3. MAXIMUM LEAD THICKNESS INCLUDES LEAD FINISH. MINIMUM LEAD THICKNESS IS THE MINIMUM THICKNESS OF THE BASE MATERIAL.
4. DIMENSIONS D AND E DO NOT INCLUDE MOLD FLASH, PROTRUSIONS, OR GATE BURRS.

DIM	MILLIMETERS			INCHES		
	MIN.	NOM.	MAX.	MIN.	NOM.	MAX.
A	0.89	1.00	1.11	0.035	0.039	0.044
A1	0.01	0.06	0.10	0.000	0.002	0.004
b	0.37	0.44	0.50	0.015	0.017	0.020
c	0.08	0.14	0.20	0.003	0.006	0.008
D	2.80	2.90	3.04	0.110	0.114	0.120
E	1.20	1.30	1.40	0.047	0.051	0.055
e	1.78	1.90	2.04	0.070	0.075	0.080
L	0.30	0.43	0.55	0.012	0.017	0.022
L1	0.35	0.54	0.69	0.014	0.021	0.027
H <sub>E</sub>	2.10	2.40	2.64	0.083	0.094	0.104
T	0°	---	10°	0°	---	10°

**GENERIC MARKING DIAGRAM\***



- XXX = Specific Device Code
- M = Date Code
- = Pb-Free Package

\*This information is generic. Please refer to device data sheet for actual part marking. Pb-Free indicator, "G" or microdot "▪", may or may not be present. Some products may not follow the Generic Marking.



**RECOMMENDED MOUNTING FOOTPRINT**

\* For additional information on our Pb-Free strategy and soldering details, please download the ON Semiconductor Soldering and Mounting Techniques Reference Manual, SOLDERRM/D.

**STYLES ON PAGE 2**

<b>DOCUMENT NUMBER:</b>	<b>98ASB42226B</b>	Electronic versions are uncontrolled except when accessed directly from the Document Repository. Printed versions are uncontrolled except when stamped "CONTROLLED COPY" in red.
<b>DESCRIPTION:</b>	<b>SOT-23 (TO-236)</b>	<b>PAGE 1 OF 2</b>

onsemi and ONSEMI are trademarks of Semiconductor Components Industries, LLC dba onsemi or its subsidiaries in the United States and/or other countries. onsemi reserves the right to make changes without further notice to any products herein. onsemi makes no warranty, representation or guarantee regarding the suitability of its products for any particular purpose, nor does onsemi assume any liability arising out of the application or use of any product or circuit, and specifically disclaims any and all liability, including without limitation special, consequential or incidental damages. onsemi does not convey any license under its patent rights nor the rights of others.

**MECHANICAL CASE OUTLINE**  
**PACKAGE DIMENSIONS**



**SOT-23 (TO-236)**  
**CASE 318**  
**ISSUE AT**

DATE 01 MAR 2023

- |   |   |   |   |   |   |
|---|---|---|---|---|---|
| STYLE 1 THRU 5:<br>CANCELLED                            | STYLE 6:<br>PIN 1. BASE<br>2. EMITTER<br>3. COLLECTOR | STYLE 7:<br>PIN 1. EMITTER<br>2. BASE<br>3. COLLECTOR       | STYLE 8:<br>PIN 1. ANODE<br>2. NO CONNECTION<br>3. CATHODE  |   |   |
| STYLE 9:<br>PIN 1. ANODE<br>2. ANODE<br>3. CATHODE      | STYLE 10:<br>PIN 1. DRAIN<br>2. SOURCE<br>3. GATE     | STYLE 11:<br>PIN 1. ANODE<br>2. CATHODE<br>3. CATHODE-ANODE | STYLE 12:<br>PIN 1. CATHODE<br>2. CATHODE<br>3. ANODE       | STYLE 13:<br>PIN 1. SOURCE<br>2. DRAIN<br>3. GATE           | STYLE 14:<br>PIN 1. CATHODE<br>2. GATE<br>3. ANODE          |
| STYLE 15:<br>PIN 1. GATE<br>2. CATHODE<br>3. ANODE      | STYLE 16:<br>PIN 1. ANODE<br>2. CATHODE<br>3. CATHODE | STYLE 17:<br>PIN 1. NO CONNECTION<br>2. ANODE<br>3. CATHODE | STYLE 18:<br>PIN 1. NO CONNECTION<br>2. CATHODE<br>3. ANODE | STYLE 19:<br>PIN 1. CATHODE<br>2. ANODE<br>3. CATHODE-ANODE | STYLE 20:<br>PIN 1. CATHODE<br>2. ANODE<br>3. GATE          |
| STYLE 21:<br>PIN 1. GATE<br>2. SOURCE<br>3. DRAIN       | STYLE 22:<br>PIN 1. RETURN<br>2. OUTPUT<br>3. INPUT   | STYLE 23:<br>PIN 1. ANODE<br>2. ANODE<br>3. CATHODE         | STYLE 24:<br>PIN 1. GATE<br>2. DRAIN<br>3. SOURCE           | STYLE 25:<br>PIN 1. ANODE<br>2. CATHODE<br>3. GATE          | STYLE 26:<br>PIN 1. CATHODE<br>2. ANODE<br>3. NO CONNECTION |
| STYLE 27:<br>PIN 1. CATHODE<br>2. CATHODE<br>3. CATHODE | STYLE 28:<br>PIN 1. ANODE<br>2. ANODE<br>3. ANODE     |   |   |   |   |

<b>DOCUMENT NUMBER:</b>	<b>98ASB42226B</b>	Electronic versions are uncontrolled except when accessed directly from the Document Repository. Printed versions are uncontrolled except when stamped "CONTROLLED COPY" in red.
<b>DESCRIPTION:</b>	<b>SOT-23 (TO-236)</b>	<b>PAGE 2 OF 2</b>

**onsemi** and **ONSEMI** are trademarks of Semiconductor Components Industries, LLC dba **onsemi** or its subsidiaries in the United States and/or other countries. **onsemi** reserves the right to make changes without further notice to any products herein. **onsemi** makes no warranty, representation or guarantee regarding the suitability of its products for any particular purpose, nor does **onsemi** assume any liability arising out of the application or use of any product or circuit, and specifically disclaims any and all liability, including without limitation special, consequential or incidental damages. **onsemi** does not convey any license under its patent rights nor the rights of others.

# MECHANICAL CASE OUTLINE PACKAGE DIMENSIONS



SCALE 4:1

## SC-70 (SOT-323) CASE 419 ISSUE R

DATE 11 OCT 2022

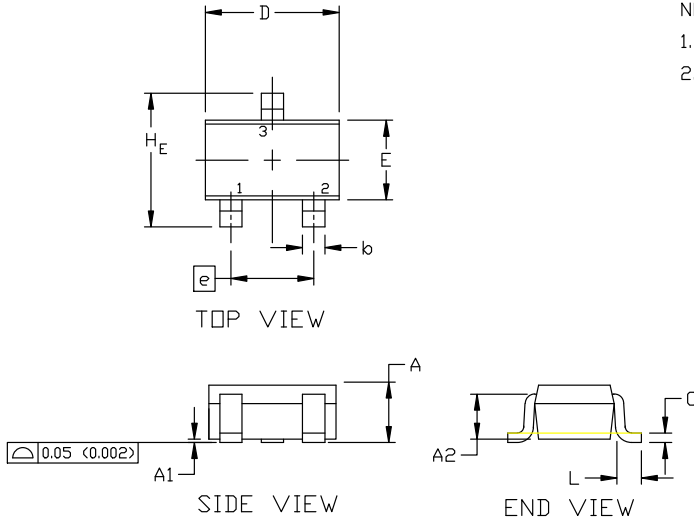

NOTES:

- DIMENSIONING AND TOLERANCING PER ASME Y14.5M, 1982.
- CONTROLLING DIMENSION: INCH

DIM	MILLIMETERS			INCHES		
	MIN.	NOM.	MAX.	MIN.	NOM.	MAX.
A	0.80	0.90	1.00	0.032	0.035	0.040
A1	0.00	0.05	0.10	0.000	0.002	0.004
A2	0.70 REF			0.028 BSC		
b	0.30	0.35	0.40	0.012	0.014	0.016
c	0.10	0.18	0.25	0.004	0.007	0.010
D	1.80	2.00	2.20	0.071	0.080	0.087
E	1.15	1.24	1.35	0.045	0.049	0.053
e	1.20	1.30	1.40	0.047	0.051	0.055
e1	0.65 BSC			0.026 BSC		
L	0.20	0.38	0.56	0.008	0.015	0.022
H <sub>E</sub>	2.00	2.10	2.40	0.079	0.083	0.095

### GENERIC MARKING DIAGRAM



- XX = Specific Device Code
- M = Date Code
- = Pb-Free Package

\*This information is generic. Please refer to device data sheet for actual part marking. Pb-Free indicator, "G" or microdot "▪", may or may not be present. Some products may not follow the Generic Marking.

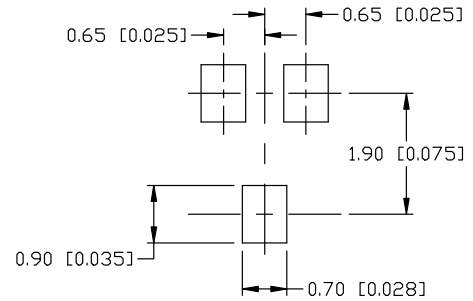

\* For additional information on our Pb-Free strategy and soldering details, please download the DN Semiconductor Soldering and Mounting Techniques Reference Manual, SOLDERM/D.

### SOLDERING FOOTPRINT

STYLE 1: CANCELLED	STYLE 2: PIN 1. ANODE 2. N.C. 3. CATHODE	STYLE 3: PIN 1. BASE 2. EMITTER 3. COLLECTOR	STYLE 4: PIN 1. CATHODE 2. CATHODE 3. ANODE	STYLE 5: PIN 1. ANODE 2. ANODE 3. CATHODE
STYLE 6: PIN 1. EMITTER 2. BASE 3. COLLECTOR	STYLE 7: PIN 1. BASE 2. EMITTER 3. COLLECTOR	STYLE 8: PIN 1. GATE 2. SOURCE 3. DRAIN	STYLE 9: PIN 1. ANODE 2. CATHODE 3. CATHODE-ANODE	STYLE 10: PIN 1. CATHODE 2. ANODE 3. ANODE-CATHODE
				STYLE 11: PIN 1. CATHODE 2. CATHODE 3. CATHODE

DOCUMENT NUMBER:	98ASB42819B	Electronic versions are uncontrolled except when accessed directly from the Document Repository. Printed versions are uncontrolled except when stamped "CONTROLLED COPY" in red.
DESCRIPTION:	SC-70 (SOT-323)	PAGE 1 OF 1

onsemi and ONSEMI are trademarks of Semiconductor Components Industries, LLC dba onsemi or its subsidiaries in the United States and/or other countries. onsemi reserves the right to make changes without further notice to any products herein. onsemi makes no warranty, representation or guarantee regarding the suitability of its products for any particular purpose, nor does onsemi assume any liability arising out of the application or use of any product or circuit, and specifically disclaims any and all liability, including without limitation special, consequential or incidental damages. onsemi does not convey any license under its patent rights nor the rights of others.



# MECHANICAL CASE OUTLINE

## PACKAGE DIMENSIONS



**SC75-3 1.60x0.80x0.80, 1.00P**  
**CASE 463**  
**ISSUE H**

DATE 01 FEB 2024

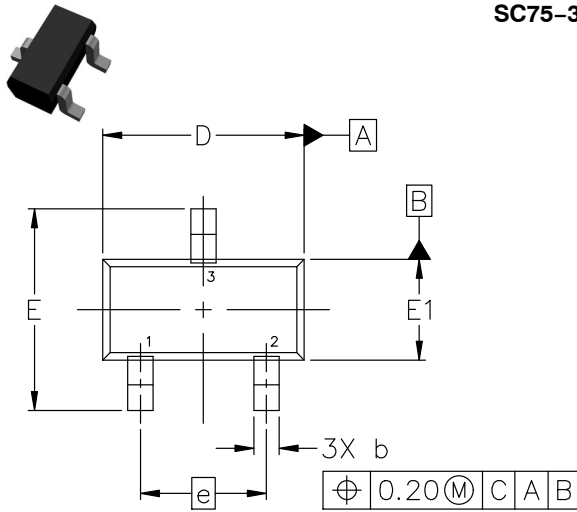

TOP VIEW

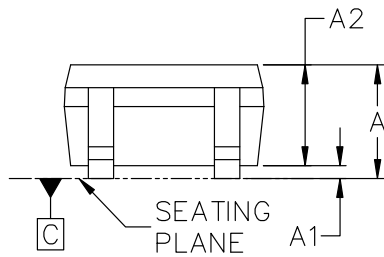

SIDE VIEW

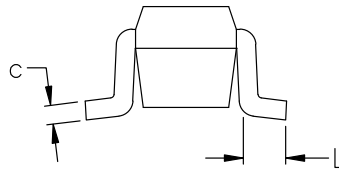

END VIEW

### GENERIC MARKING DIAGRAM\*

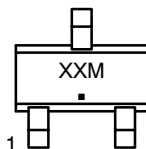

- XX = Specific Device Code
- M = Date Code
- = Pb-Free Package

\*This information is generic. Please refer to device data sheet for actual part marking. Pb-Free indicator, "G" or microdot "▪", may or may not be present. Some products may not follow the Generic Marking.

- STYLE 1:  
PIN 1. BASE  
2. EMITTER  
3. COLLECTOR
- STYLE 2:  
PIN 1. ANODE  
2. N/C  
3. CATHODE
- STYLE 3:  
PIN 1. ANODE  
2. ANODE  
3. CATHODE
- STYLE 4:  
PIN 1. CATHODE  
2. CATHODE  
3. ANODE
- STYLE 5:  
PIN 1. GATE  
2. SOURCE  
3. DRAIN

### NOTES:

- DIMENSIONING AND TOLERANCING CONFORM TO ASME Y14.5-2018.
- ALL DIMENSION ARE IN MILLIMETERS.

DIM	MILLIMETERS		
	MIN.	NOM.	MAX.
A	0.70	0.80	0.90
A1	0.00	0.05	0.10
A2	0.80 REF.		
b	0.15	0.20	0.30
c	0.10	0.15	0.25
D	1.55	1.60	1.65
E	1.50	1.60	1.70
E1	0.70	0.80	0.90
e	1.00 BSC		
L	0.10	0.15	0.20

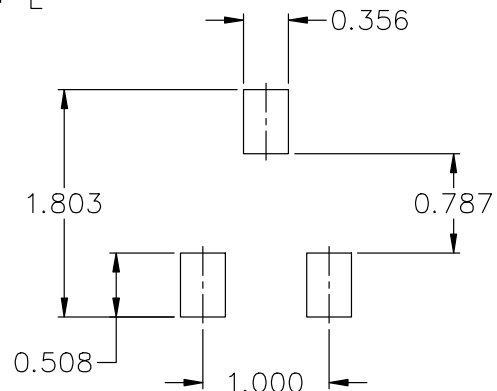

### RECOMMENDED MOUNTING FOOTPRINT\*

\* FOR ADDITIONAL INFORMATION ON OUR Pb-FREE STRATEGY AND SOLDERING DETAILS, PLEASE DOWNLOAD THE ON SEMICONDUCTOR SOLDERING AND MOUNTING TECHNIQUES REFERENCE MANUAL, SOLDERRM/D.

<b>DOCUMENT NUMBER:</b>	<b>98ASB15184C</b>	Electronic versions are uncontrolled except when accessed directly from the Document Repository. Printed versions are uncontrolled except when stamped "CONTROLLED COPY" in red.
<b>DESCRIPTION:</b>	<b>SC75-3 1.60x0.80x0.80, 1.00P</b>	<b>PAGE 1 OF 1</b>

onsemi and ONSEMI are trademarks of Semiconductor Components Industries, LLC dba onsemi or its subsidiaries in the United States and/or other countries. onsemi reserves the right to make changes without further notice to any products herein. onsemi makes no warranty, representation or guarantee regarding the suitability of its products for any particular purpose, nor does onsemi assume any liability arising out of the application or use of any product or circuit, and specifically disclaims any and all liability, including without limitation special, consequential or incidental damages. onsemi does not convey any license under its patent rights nor the rights of others.

# MECHANICAL CASE OUTLINE

## PACKAGE DIMENSIONS

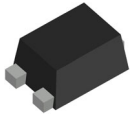

**SOT-1123 0.80x0.60x0.37, 0.35P**  
**CASE 524AA**  
**ISSUE D**

DATE 18 JAN 2024

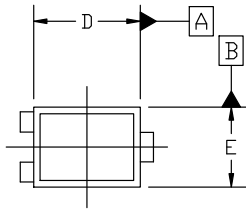

TOP VIEW

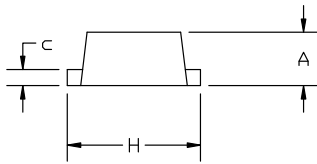

SIDE VIEW

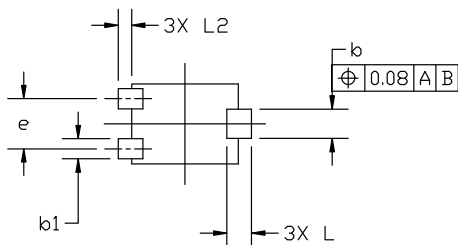

BOTTOM VIEW

**GENERIC MARKING DIAGRAM\***

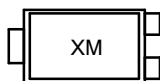

X = Specific Device Code  
M = Date Code

\*This information is generic. Please refer to device data sheet for actual part marking. Pb-Free indicator, "G" or microdot "•", may or may not be present. Some products may not follow the Generic Marking.

NOTES:

1. DIMENSIONING AND TOLERANCING PER ASME Y14.5M, 2018.
2. CONTROLLING DIMENSION: MILLIMETERS.
3. MAXIMUM LEAD THICKNESS INCLUDES LEAD FINISH. MINIMUM LEAD THICKNESS IS THE MINIMUM THICKNESS OF BASE MATERIAL.
4. DIMENSIONS D AND E DO NOT INCLUDE MOLD FLASH, PROTRUSIONS, OR GATE BURRS.

MILLIMETERS			
DIM	MIN	NOM	MAX
A	0.34	0.37	0.40
b	0.15	0.22	0.28
b1	0.10	0.15	0.20
c	0.07	0.12	0.17
D	0.75	0.80	0.85
E	0.55	0.60	0.65
e	0.35	0.38	0.40
H	0.950	1.000	1.050
L	0.185 REF		
L2	0.05	0.10	0.15

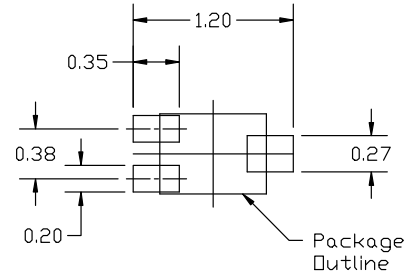

**RECOMMENDED MOUNTING FOOTPRINT**

\*For additional information on our Pb-Free strategy and soldering details, please download the ON Semiconductor Soldering and Mounting Techniques Reference manual, SOLDERM/D.

STYLE 1: PIN 1. BASE 2. EMITTER 3. COLLECTOR	STYLE 2: PIN 1. ANODE 2. N/C 3. CATHODE	STYLE 3: PIN 1. ANODE 2. ANODE 3. CATHODE	STYLE 4: PIN 1. CATHODE 2. CATHODE 3. ANODE	STYLE 5: PIN 1. GATE 2. SOURCE 3. DRAIN
---	--	--	--	--

<b>DOCUMENT NUMBER:</b>	<b>98AON23134D</b>	Electronic versions are uncontrolled except when accessed directly from the Document Repository. Printed versions are uncontrolled except when stamped "CONTROLLED COPY" in red.
<b>DESCRIPTION:</b>	<b>SOT-1123 0.80x0.60x0.37, 0.35P</b>	<b>PAGE 1 OF 1</b>

onsemi and ONSEMI are trademarks of Semiconductor Components Industries, LLC dba onsemi or its subsidiaries in the United States and/or other countries. onsemi reserves the right to make changes without further notice to any products herein. onsemi makes no warranty, representation or guarantee regarding the suitability of its products for any particular purpose, nor does onsemi assume any liability arising out of the application or use of any product or circuit, and specifically disclaims any and all liability, including without limitation special, consequential or incidental damages. onsemi does not convey any license under its patent rights nor the rights of others.

# MECHANICAL CASE OUTLINE

## PACKAGE DIMENSIONS

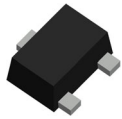

**SOT-723 1.20x0.80x0.50, 0.40P**  
**CASE 631AA**  
**ISSUE E**

DATE 24 JAN 2024

**NOTES:**

1. DIMENSIONING AND TOLERANCING PER ASME Y14.5M, 2018.
2. CONTROLLING DIMENSION: MILLIMETERS.
3. MAXIMUM LEAD THICKNESS INCLUDES LEAD FINISH. MINIMUM LEAD THICKNESS IS THE MINIMUM THICKNESS OF BASE MATERIAL.
4. DIMENSIONS D AND E DO NOT INCLUDE MOLD FLASH, PROTRUSIONS OR GATE BURRS.

DIM	MILLIMETERS		
	MIN.	NOM.	MAX.
A	0.45	0.50	0.55
b	0.15	0.21	0.27
b1	0.25	0.31	0.37
c	0.07	0.12	0.17
D	1.15	1.20	1.25
E	0.75	0.80	0.85
e	0.40 BSC		
H	1.15	1.20	1.25
L	0.29 REF		
L2	0.15	0.20	0.25

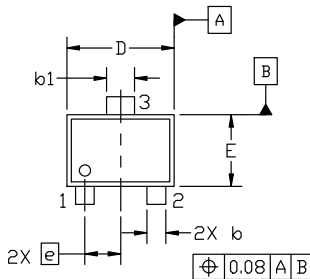

TOP VIEW

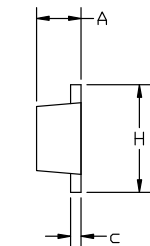

SIDE VIEW

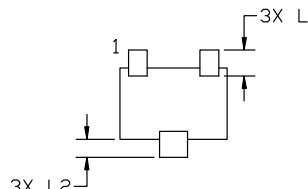

BOTTOM VIEW

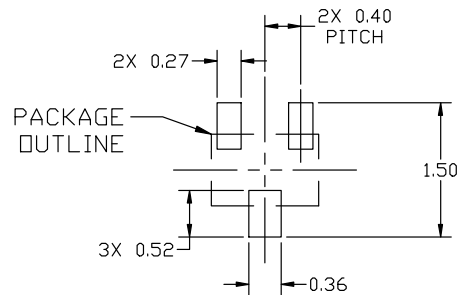

RECOMMENDED MOUNTING FOOTPRINT

**GENERIC MARKING DIAGRAM\***

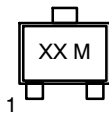

XX = Specific Device Code  
M = Date Code

\*This information is generic. Please refer to device data sheet for actual part marking. Pb-Free indicator, "G" or microdot "•", may or may not be present. Some products may not follow the Generic Marking.

\*For additional information on our Pb-Free strategy and soldering details, please download the ON Semiconductor Soldering and Mounting Techniques Reference Manual, SOLDERRM/D.

STYLE 1:	STYLE 2:	STYLE 3:	STYLE 4:	STYLE 5:
PIN 1. BASE	PIN 1. ANODE	PIN 1. ANODE	PIN 1. CATHODE	PIN 1. GATE
2. EMITTER	2. N/C	2. ANODE	2. CATHODE	2. SOURCE
3. COLLECTOR	3. CATHODE	3. CATHODE	3. ANODE	3. DRAIN

<b>DOCUMENT NUMBER:</b>	<b>98AON12989D</b>	Electronic versions are uncontrolled except when accessed directly from the Document Repository. Printed versions are uncontrolled except when stamped "CONTROLLED COPY" in red.
<b>DESCRIPTION:</b>	<b>SOT-723 1.20x0.80x0.50, 0.40P</b>	<b>PAGE 1 OF 1</b>

onsemi and ONSEMI are trademarks of Semiconductor Components Industries, LLC dba onsemi or its subsidiaries in the United States and/or other countries. onsemi reserves the right to make changes without further notice to any products herein. onsemi makes no warranty, representation or guarantee regarding the suitability of its products for any particular purpose, nor does onsemi assume any liability arising out of the application or use of any product or circuit, and specifically disclaims any and all liability, including without limitation special, consequential or incidental damages. onsemi does not convey any license under its patent rights nor the rights of others.

**onsemi**, **Onsemi**, and other names, marks, and brands are registered and/or common law trademarks of Semiconductor Components Industries, LLC dba "**onsemi**" or its affiliates and/or subsidiaries in the United States and/or other countries. **onsemi** owns the rights to a number of patents, trademarks, copyrights, trade secrets, and other intellectual property. A listing of **onsemi**'s product/patent coverage may be accessed at [www.onsemi.com/site/pdf/Patent-Marking.pdf](http://www.onsemi.com/site/pdf/Patent-Marking.pdf). **onsemi** reserves the right to make changes at any time to any products or information herein, without notice. The information herein is provided "as-is" and **onsemi** makes no warranty, representation or guarantee regarding the accuracy of the information, product features, availability, functionality, or suitability of its products for any particular purpose, nor does **onsemi** assume any liability arising out of the application or use of any product or circuit, and specifically disclaims any and all liability, including without limitation special, consequential or incidental damages. Buyer is responsible for its products and applications using **onsemi** products, including compliance with all laws, regulations and safety requirements or standards, regardless of any support or applications information provided by **onsemi**. "Typical" parameters which may be provided in **onsemi** data sheets and/or specifications can and do vary in different applications and actual performance may vary over time. All operating parameters, including "Typicals" must be validated for each customer application by customer's technical experts. **onsemi** does not convey any license under any of its intellectual property rights nor the rights of others. **onsemi** products are not designed, intended, or authorized for use as a critical component in life support systems or any FDA Class 3 medical devices or medical devices with a same or similar classification in a foreign jurisdiction or any devices intended for implantation in the human body. Should Buyer purchase or use **onsemi** products for any such unintended or unauthorized application, Buyer shall indemnify and hold **onsemi** and its officers, employees, subsidiaries, affiliates, and distributors harmless against all claims, costs, damages, and expenses, and reasonable attorney fees arising out of, directly or indirectly, any claim of personal injury or death associated with such unintended or unauthorized use, even if such claim alleges that **onsemi** was negligent regarding the design or manufacture of the part. **onsemi** is an Equal Opportunity/Affirmative Action Employer. This literature is subject to all applicable copyright laws and is not for resale in any manner.

## ADDITIONAL INFORMATION

### TECHNICAL PUBLICATIONS:

Technical Library: [www.onsemi.com/design/resources/technical-documentation](http://www.onsemi.com/design/resources/technical-documentation)  
onsemi Website: [www.onsemi.com](http://www.onsemi.com)

### ONLINE SUPPORT: [www.onsemi.com/support](http://www.onsemi.com/support)

For additional information, please contact your local Sales Representative at [www.onsemi.com/support/sales](http://www.onsemi.com/support/sales)