



NGW30T60M3DF

600 V, 30 A trench field-stop IGBT with full rated silicon diode

Rev. 1 — 3 July 2023

Product data sheet

1. General description

The NGW30T60M3DF is a robust Insulated-Gate Bipolar Transistor (IGBT) featuring third-generation technology. It combines carrier stored trench-gate and field-stop (FS) structures. The NGW30T60M3DF is rated to 175 °C with optimized IGBT turn-off losses, and has a short circuit withstand time of 5 μ s. This hard-switching 600 V, 30 A IGBT is optimized for high-voltage, low-frequency industrial power inverter and servo motor drive applications.

2. Features and benefits

- Collector current (I_C) rated at 30 A
- Low conduction and switching losses
- Stable and tight parameters for easy parallel operation
- Maximum junction temperature of 175 °C
- Fully rated as a soft fast reverse recovery diode
- 5 μ s short circuit withstand time
- RoHS compliant, lead-free plating

3. Applications

- Motor drives for industrial and consumer appliances
 - Servo motors operating between 5-20 kW (up to 20 kHz) for robotics, elevators, operating grippers, in-line manufacturing, etc.
- Power inverters
 - Uninterruptible Power Supply (UPS) inverter
 - Photovoltaic (PV) strings
 - EV charging
- Induction heating
- Welding

4. Quick reference data

Table 1. Quick reference data

Symbol	Parameter	Conditions	Min	Max	Unit
V_{CE}	collector-emitter voltage	$T_j = 25\text{ °C}$	-	600	V
T_j	operating junction temperature		-40	+175	°C
t_{sc}	short circuit withstand time	$V_{GE} = 15\text{ V}; V_{CC} = 400\text{ V}; T_j \leq 150\text{ °C}$	-	5	μ s

5. Pinning information

Table 2. Pinning information

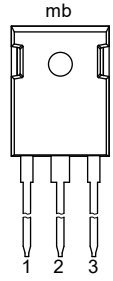
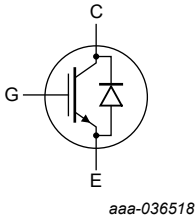
Pin	Symbol	Description	Simplified outline	Graphic symbol
1	G	gate		
2	C	collector		
3	E	emitter		
mb	C	mounting base; connected to collector		

6. Ordering information

Table 3. Ordering information

Type number	Package		
	Name	Description	Version
NGW30T60M3DF	TO-247-3L	Plastic single-ended through-hole package; heatsink mounted; 1 mounting hole; 3-lead TO-247-3L	SOT429-2

7. Limiting values

Table 4. Limiting values

In accordance with the Absolute Maximum Rating System (IEC 60134).

Symbol	Parameter	Conditions	Min	Max	Unit
IGBT					
V_{CE}	collector-emitter voltage	$T_j = 25\text{ °C}$	-	600	V
I_C	collector current	$T_{case} = 25\text{ °C}$ [1]	-	75	A
		$T_{case} = 100\text{ °C}$ [1]	-	45	A
I_{Cpuls}	peak pulse collector current [2]		-	90	A
t_{sc}	short circuit withstand time	$V_{GE} = 15\text{ V}; V_{CC} = 400\text{ V}; T_j \leq 150\text{ °C}$	-	5.0	μs
V_{GS}	gate-source voltage		-20	+20	V
P_{tot}	total power dissipation	$T_{case} = 25\text{ °C}$	-	285	W
		$T_{case} = 100\text{ °C}$	-	142	W
T_j	operating junction temperature		-40	+175	$^{\circ}\text{C}$
T_{stg}	storage temperature		-55	+150	$^{\circ}\text{C}$
T_{solder}	soldering temperature		-	260	$^{\circ}\text{C}$
M	mounting torque, M3 screw		-	0.6	Nm
Diode					
I_F	diode forward current	$T_{case} = 25\text{ °C}$ [1]	-	80	A
		$T_{case} = 100\text{ °C}$ [1]	-	58	A
I_{Fpuls}	peak pulse diode current [2]	$T_{case} = 25\text{ °C}$		90	A

[1] Value limited by bondwire and $T_{j(max)}$.

[2] t_p limited by $T_{j(max)}$.

8. Thermal characteristics

Table 5. Thermal characteristics

Symbol	Parameter	Conditions	Min	Typ	Max	Unit
$R_{th(j-c)}$	thermal resistance from junction to case	IGBT	-	0.45	0.53	K/W
		diode	-	0.71	0.84	K/W
$R_{th(j-a)}$	thermal resistance from junction to ambient	in free air	-	-	40	K/W

9. Characteristics

Table 6. Characteristics

All values at $T_j = 25\text{ °C}$, unless otherwise specified.

Symbol	Parameter	Conditions	Min	Typ	Max	Unit
Static characteristics						
$V_{(BR)CE}$	collector-emitter breakdown voltage	$V_{GE} = 0\text{ V}; I_C = 0.2\text{ mA}$	600	-	-	V
V_{CEsat}	collector-emitter saturation voltage	$V_{GE} = 15\text{ V}; I_C = 30\text{ A}; T_j = 25\text{ °C}$	-	1.4	1.7	V
		$V_{GE} = 15\text{ V}; I_C = 30\text{ A}; T_j = 175\text{ °C}$	-	1.7	-	V
V_F	diode forward voltage	$V_{GE} = 0\text{ V}; I_F = 30\text{ A}; T_j = 25\text{ °C}$	-	1.5	2.2	V
		$V_{GE} = 0\text{ V}; I_F = 30\text{ A}; T_j = 175\text{ °C}$	-	1.2	-	V
$V_{GE(th)}$	gate-emitter threshold voltage	$I_C = 0.3\text{ mA}; V_{CE} = V_{GE}; T_j = 25\text{ °C}$	4	5	7	V
I_{CES}	zero gate voltage collector current	$V_{CE} = 600\text{ V}; V_{GE} = 0\text{ V}; T_j = 25\text{ °C}$	-	-	400	μA
		$V_{CE} = 600\text{ V}; V_{GE} = 0\text{ V}; T_j = 175\text{ °C}$	-	-	10	mA
I_{GES}	gate-emitter leakage current	$V_{CE} = 0\text{ V}; V_{GE} = 20\text{ V}$	-	-	200	nA
g_{fs}	transconductance	$V_{CE} = 20\text{ V}; I_C = 30\text{ A}; T_j = 25\text{ °C}$	-	18.5	-	S
r_G	integrated gate resistor		-	0.9	-	Ω
Dynamic characteristics						
C_{ies}	input capacitance	$V_{CE} = 25\text{ V}; V_{GE} = 0\text{ V}; f = 1\text{ MHz}$	-	2040	-	pF
C_{oes}	output capacitance		-	136	-	pF
C_{res}	reverse transfer capacitance		-	31	-	pF
Q_G	gate charge	$V_{CC} = 480\text{ V}; V_{GE} = 15\text{ V}; I_C = 30\text{ A}$	-	130	-	nC
L_{sCE}	internal stray inductance	Measured 5 mm from case	-	7.9	-	nH
$I_{C(sc)}$	short circuit collector current	$V_{GE} = 15\text{ V}; V_{CC} = 400\text{ V}; t_{sc} \leq 5\text{ }\mu\text{s}; T_j \leq 150\text{ °C}$	-	130	-	A

600 V, 30 A trench field-stop IGBT with full rated silicon diode

Symbol	Parameter	Conditions	Min	Typ	Max	Unit	
IGBT switching characteristics, inductive load							
$t_{d(on)}$	turn-on delay time	$V_{GE} = 15/0\text{ V}$; $V_{CC} = 400\text{ V}$; $I_C = 30\text{ A}$; $r_{G(on)} = 10\ \Omega$; $r_{G(off)} = 10\ \Omega$; see Fig. 26 and Fig. 27	$T_j = 25\text{ }^\circ\text{C}$	-	60	-	ns
			$T_j = 175\text{ }^\circ\text{C}$	-	60	-	ns
t_r	rise time		$T_j = 25\text{ }^\circ\text{C}$	-	40	-	ns
			$T_j = 175\text{ }^\circ\text{C}$	-	45	-	ns
$t_{d(off)}$	turn-off delay time		$T_j = 25\text{ }^\circ\text{C}$	-	180	-	ns
			$T_j = 175\text{ }^\circ\text{C}$	-	225	-	ns
t_f	fall time		$T_j = 25\text{ }^\circ\text{C}$	-	15	-	ns
			$T_j = 175\text{ }^\circ\text{C}$	-	45	-	ns
E_{on}	turn-on switching loss		$T_j = 25\text{ }^\circ\text{C}$	-	0.7	-	mJ
			$T_j = 175\text{ }^\circ\text{C}$	-	0.85	-	mJ
E_{off}	turn-off switching loss		$T_j = 25\text{ }^\circ\text{C}$	-	0.4	-	mJ
			$T_j = 175\text{ }^\circ\text{C}$	-	0.75	-	mJ
E_{ts}	total switching loss		$T_j = 25\text{ }^\circ\text{C}$	-	1.1	-	mJ
			$T_j = 175\text{ }^\circ\text{C}$	-	1.6	-	mJ
Diode switching characteristics, inductive load							
t_{rr}	diode reverse recovery time	$V_R = 400\text{ V}$; $I_F = 30\text{ A}$; $\Delta I_F/\Delta t = 500\text{ A}/\mu\text{s}$; see Fig. 25	$T_j = 25\text{ }^\circ\text{C}$	-	110	-	ns
			$T_j = 175\text{ }^\circ\text{C}$	-	195	-	ns
Q_{rr}	diode reverse recovery charge		$T_j = 25\text{ }^\circ\text{C}$	-	850	-	nC
			$T_j = 175\text{ }^\circ\text{C}$	-	3250	-	nC
I_{rrm}	diode peak reverse recovery current		$T_j = 25\text{ }^\circ\text{C}$	-	13	-	A
			$T_j = 175\text{ }^\circ\text{C}$	-	25	-	A
E_{rr}	reverse recovery energy		$T_j = 25\text{ }^\circ\text{C}$	-	0.15	-	mJ
			$T_j = 175\text{ }^\circ\text{C}$	-	0.55	-	mJ
di_{rr}/dt	diode peak rate of fall of reverse recovery current		$T_j = 25\text{ }^\circ\text{C}$	-	650	-	A/ μs
			$T_j = 175\text{ }^\circ\text{C}$	-	760	-	A/ μs

9.1. Output characteristics

Table 7. Waveforms and output characteristics

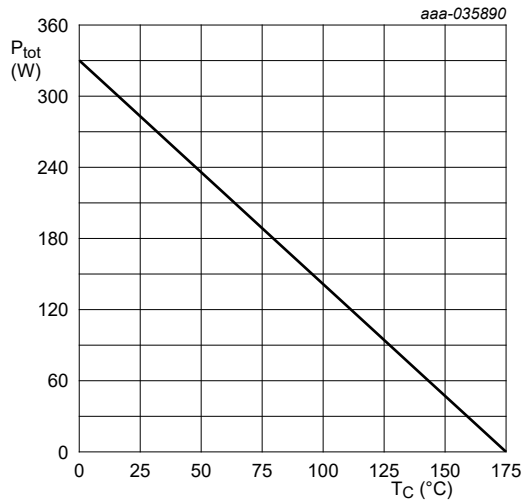

Fig. 1. Power dissipation (P_{tot}) as a function of case temperature

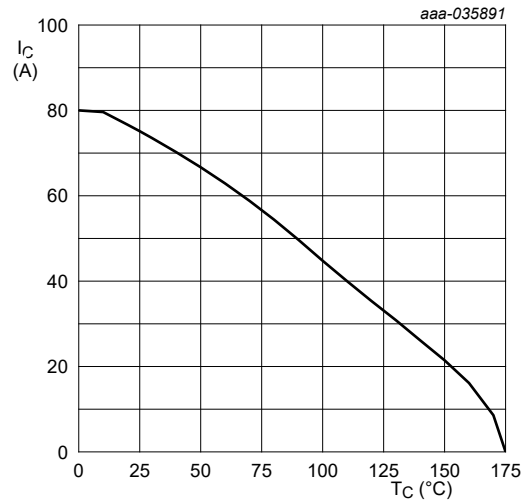
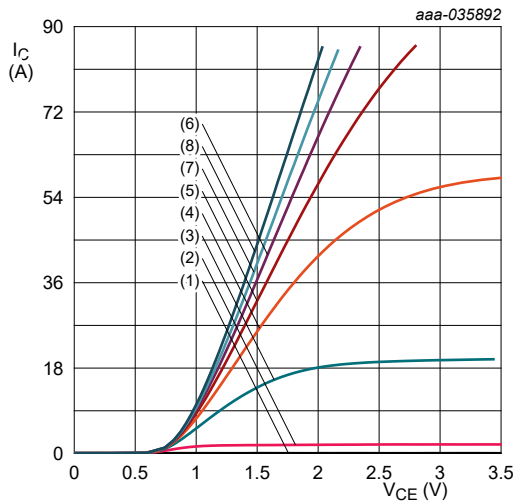
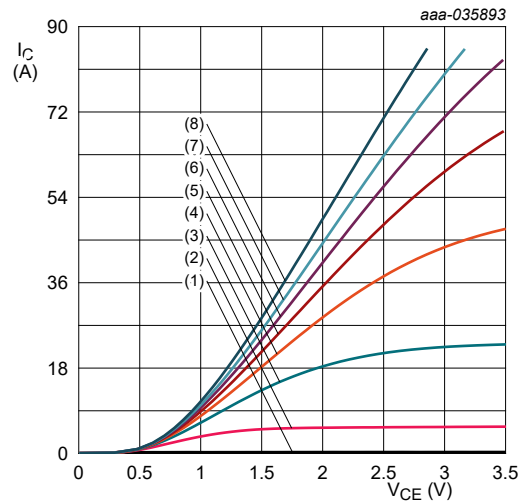

Fig. 2. Collector current (I_C) as a function of case temperature



- $T_j = 25\text{ °C}$
- (1) $V_{GE} = 5\text{ V}$
 - (2) $V_{GE} = 7\text{ V}$
 - (3) $V_{GE} = 9\text{ V}$
 - (4) $V_{GE} = 11\text{ V}$
 - (5) $V_{GE} = 13\text{ V}$
 - (6) $V_{GE} = 15\text{ V}$
 - (7) $V_{GE} = 17\text{ V}$
 - (8) $V_{GE} = 20\text{ V}$

Fig. 3. Collector current as a function of collector-emitter voltage



- $T_j = 175\text{ °C}$
- (1) $V_{GE} = 5\text{ V}$
 - (2) $V_{GE} = 7\text{ V}$
 - (3) $V_{GE} = 9\text{ V}$
 - (4) $V_{GE} = 11\text{ V}$
 - (5) $V_{GE} = 13\text{ V}$
 - (6) $V_{GE} = 15\text{ V}$
 - (7) $V_{GE} = 17\text{ V}$
 - (8) $V_{GE} = 20\text{ V}$

Fig. 4. Collector current as a function of collector-emitter voltage

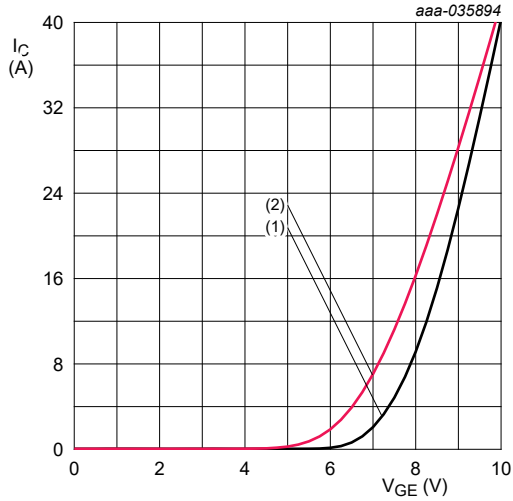

$V_{CE} = 20$ V
 (1) $T_j = 25$ °C
 (2) $T_j = 175$ °C

Fig. 5. Collector current as a function of gate-emitter voltage; typical values

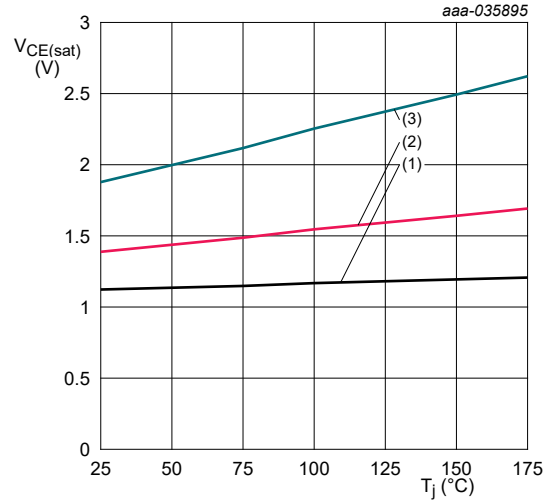

$V_{GE} = 15$ V
 (1) $I_C = 15$ A
 (2) $I_C = 30$ A
 (3) $I_C = 60$ A

Fig. 6. Collector-emitter saturation voltage as a function of junction temperature; typical values

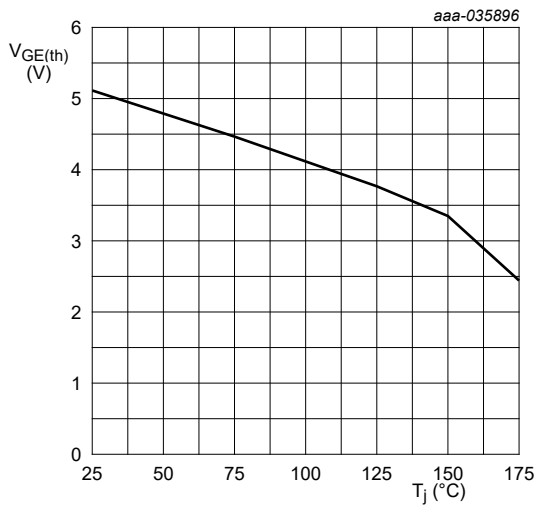
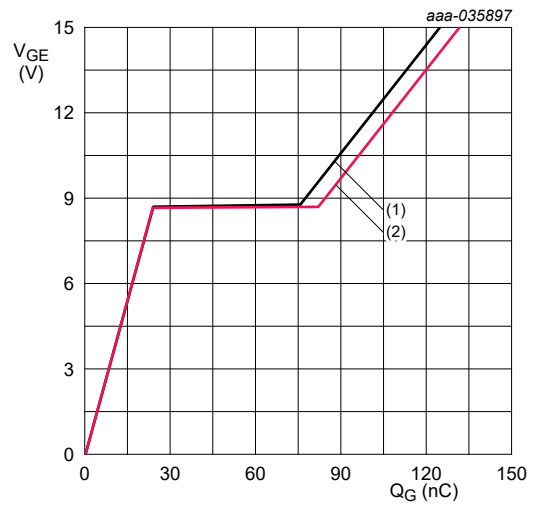
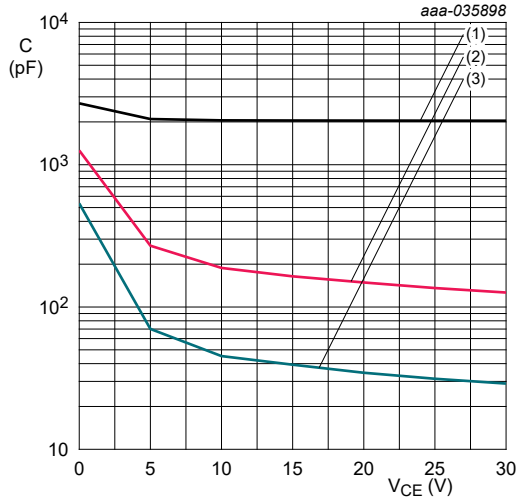

Fig. 7. Gate-emitter threshold voltage as a function of junction temperature



$I_C = 30$ A
 (1) $V_{CE} = 120$ V
 (2) $V_{CE} = 480$ V

Fig. 8. Gate-emitter voltage as a function of gate charge; typical values



$V_{GE} = 0 \text{ V}$, $f = 1 \text{ MHz}$

- (1) C_{ies}
- (2) C_{oes}
- (3) C_{res}

Fig. 9. Typical capacitance as a function of collector-emitter voltage

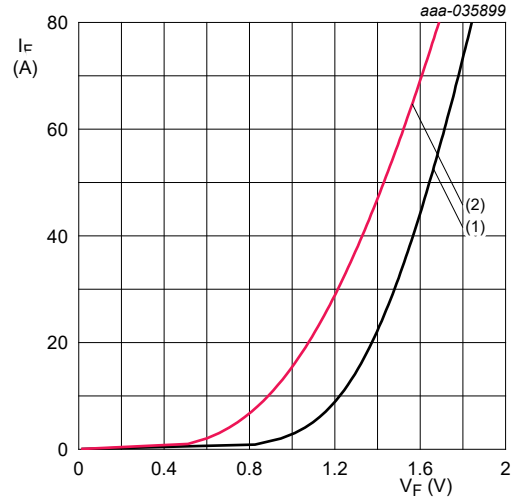

- (1) $T_{amb} = 25 \text{ °C}$
- (2) $T_{amb} = 175 \text{ °C}$

Fig. 10. Typical diode forward current as a function of forward voltage

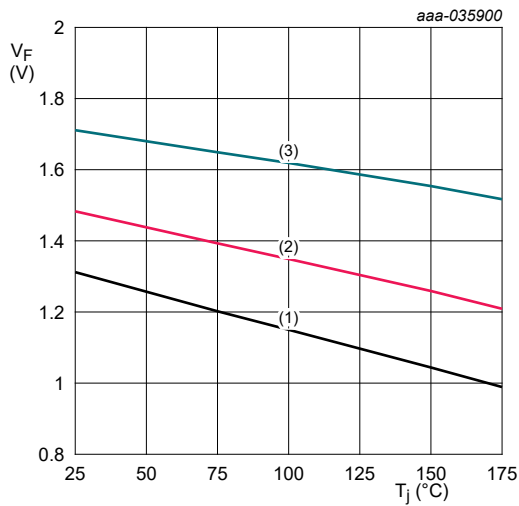

- (1) $I_F = 15 \text{ A}$
- (2) $I_F = 30 \text{ A}$
- (3) $I_F = 60 \text{ A}$

Fig. 11. Typical diode forward voltage as a function of junction temperature

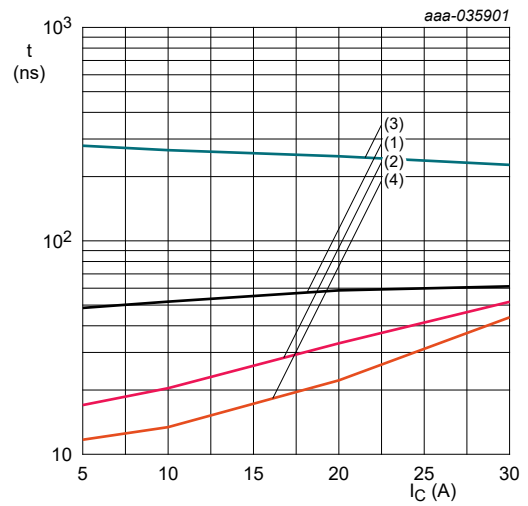

$V_{GE} = 15 \text{ V to } 0 \text{ V}$; $V_{CC} = 400 \text{ V}$; $r_{G(on)} = 10 \text{ } \Omega$;
 $r_{G(off)} = 10 \text{ } \Omega$

- (1) $t_{d(on)}$
- (2) t_r
- (3) $t_{d(off)}$
- (4) t_f

Fig. 12. Typical switching times as a function of collector current

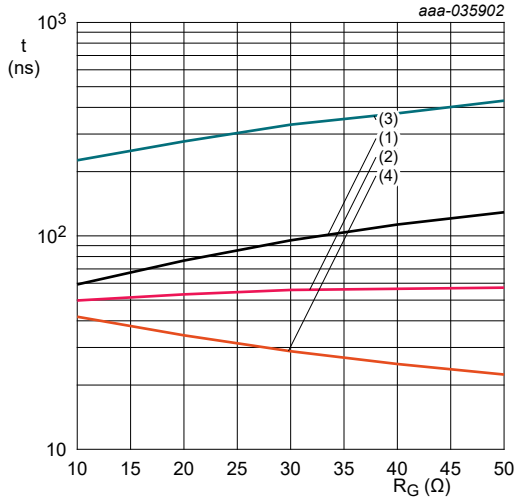

$V_{GE} = 15\text{ V to }0\text{ V}; V_{CC} = 400\text{ V}; I_C = 30\text{ A};$
 $T_j = 175\text{ }^\circ\text{C}$

- (1) $t_{d(on)}$
- (2) t_r
- (3) $t_{d(off)}$
- (4) t_f

Fig. 13. Typical switching times as a function of gate resistor

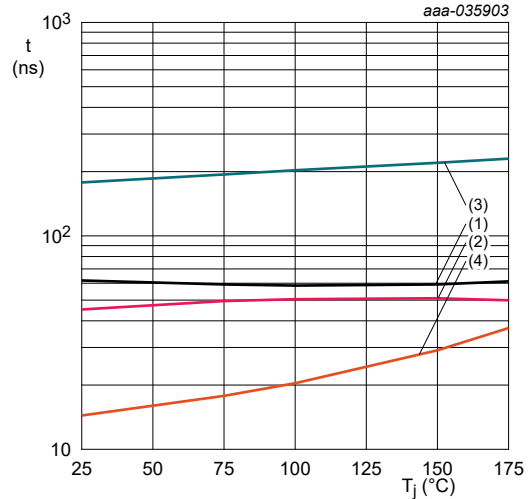

$V_{GE} = 15\text{ V to }0\text{ V}; I_C = 30\text{ A}; V_{CC} = 400\text{ V};$
 $r_{G(on)} = 10\text{ }^\Omega; r_{G(off)} = 10\text{ }^\Omega$

- (1) $t_{d(on)}$
- (2) t_r
- (3) $t_{d(off)}$
- (4) t_f

Fig. 14. Typical switching times as a function of junction temperature

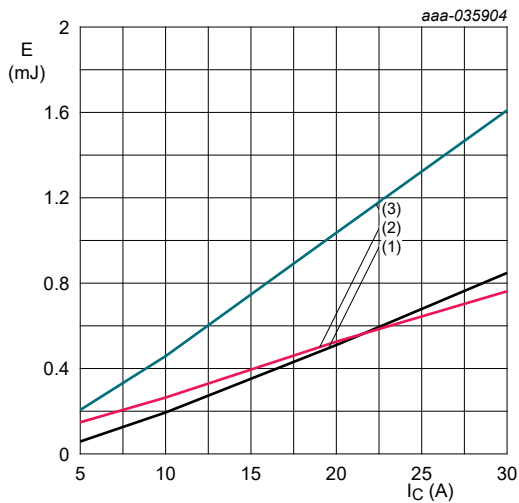

$V_{GE} = 15\text{ V to }0\text{ V}; V_{CC} = 400\text{ V}; r_{G(on)} = 10\text{ }^\Omega;$
 $r_{G(off)} = 10\text{ }^\Omega; T_j = 175\text{ }^\circ\text{C}$

- (1) E_{on}
- (2) E_{off}
- (3) E_{ts}

Fig. 15. Typical switching energy losses as a function of collector current

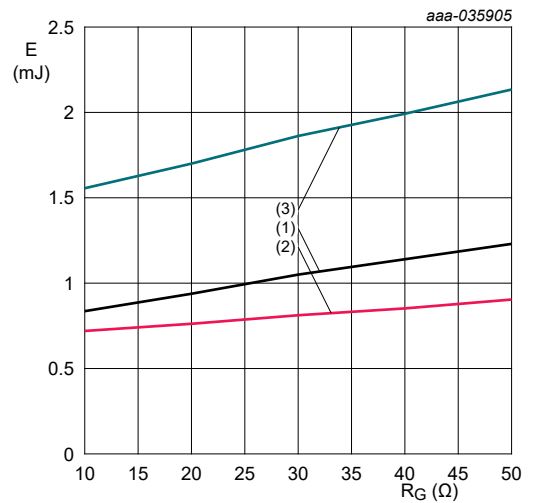

$V_{GE} = 15\text{ V to }0\text{ V}; V_{CC} = 400\text{ V}; I_C = 30\text{ A};$
 $T_j = 175\text{ }^\circ\text{C}$

- (1) E_{on}
- (2) E_{off}
- (3) E_{ts}

Fig. 16. Typical switching energy losses as a function of gate resistance

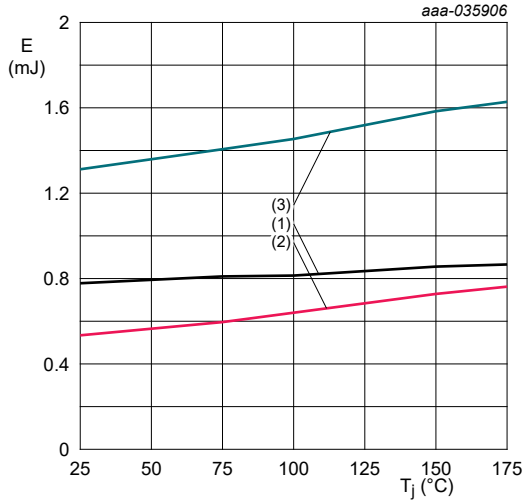

$V_{GE} = 15\text{ V to }0\text{ V}; I_C = 30\text{ A}; V_{CC} = 400\text{ V};$
 $r_{G(on)} = 10\ \Omega; r_{G(off)} = 10\ \Omega$
 (1) E_{on}
 (2) E_{off}
 (3) E_{ts}

Fig. 17. Typical switching energy losses as a function of junction temperature

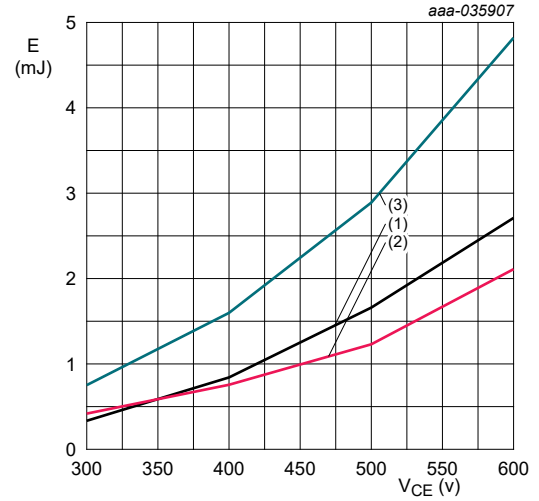

$V_{GE} = 15\text{ V to }0\text{ V}; I_C = 30\text{ A}; r_{G(on)} = 10\ \Omega;$
 $r_{G(off)} = 10\ \Omega; T_j = 175\text{ °C}$
 (1) E_{on}
 (2) E_{off}
 (3) E_{ts}

Fig. 18. Typical switching energy losses as a function of collector-emitter voltage

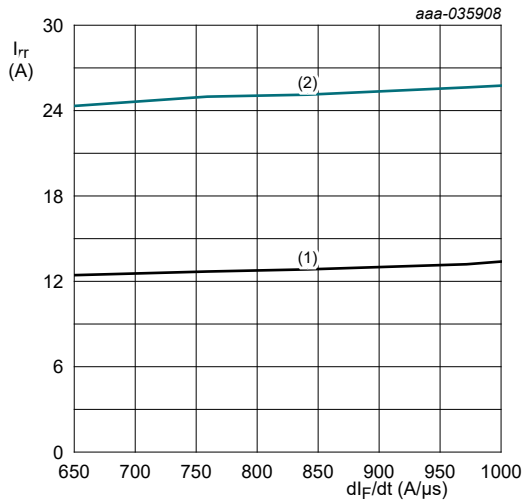

$V_R = 400\text{ V}; I_F = 30\text{ A}$
 (1) $T_{amb} = 25\text{ °C}$
 (2) $T_{amb} = 175\text{ °C}$

Fig. 19. Typical reverse recovery current as a function of rate of change of forward current

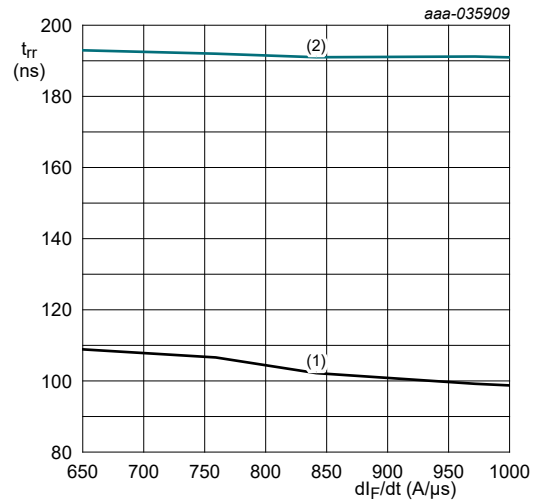

$V_R = 400\text{ V}; I_F = 30\text{ A}$
 (1) $T_{amb} = 25\text{ °C}$
 (2) $T_{amb} = 175\text{ °C}$

Fig. 20. Typical reverse recovery time as a function of rate of change of forward current

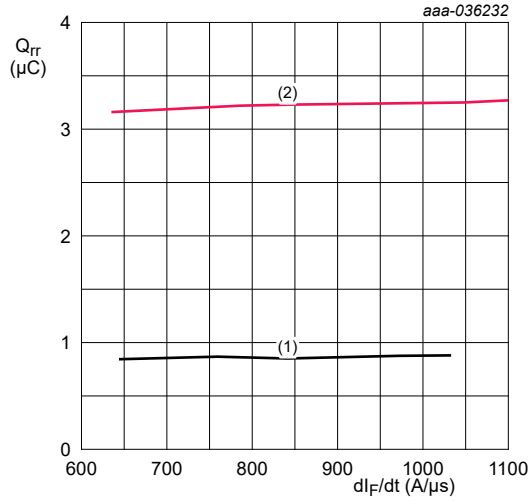

$V_R = 400 \text{ V}; I_F = 30 \text{ A}$
 (1) $T_{amb} = 25 \text{ °C}$
 (2) $T_{amb} = 175 \text{ °C}$

Fig. 21. Typical reverse recovery charge as a function of rate of change of forward current

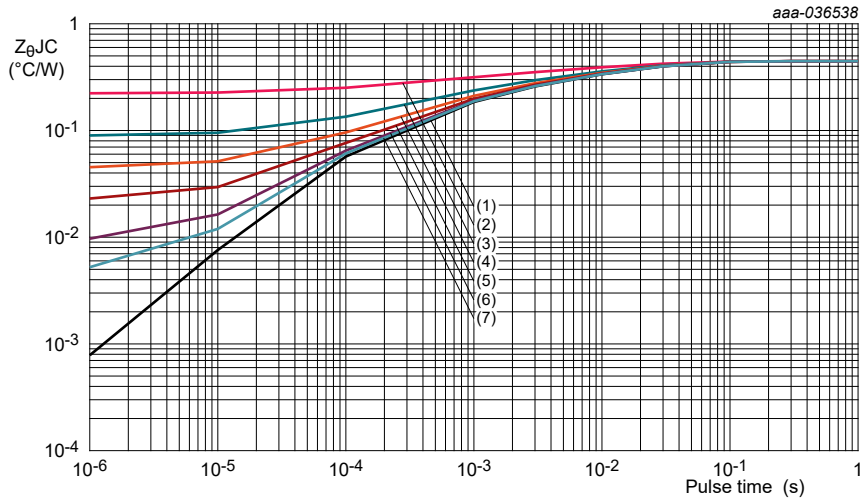

- (1) $Z_{th} (D = 0.5)$
- (2) $Z_{th} (D = 0.2)$
- (3) $Z_{th} (D = 0.1)$
- (4) $Z_{th} (D = 0.05)$
- (5) $Z_{th} (D = 0.02)$
- (6) $Z_{th} (D = 0.01)$
- (7) Single pulse ($D = 0.0$)

i	1	2	3	4
r_i [K/W]	0.056786	0.123135	0.144927	0.121162
T_i [s]	0.000113	0.000681	0.005543	0.036756

Fig. 22. Transient thermal impedance of IGBT as a function of pulse duration

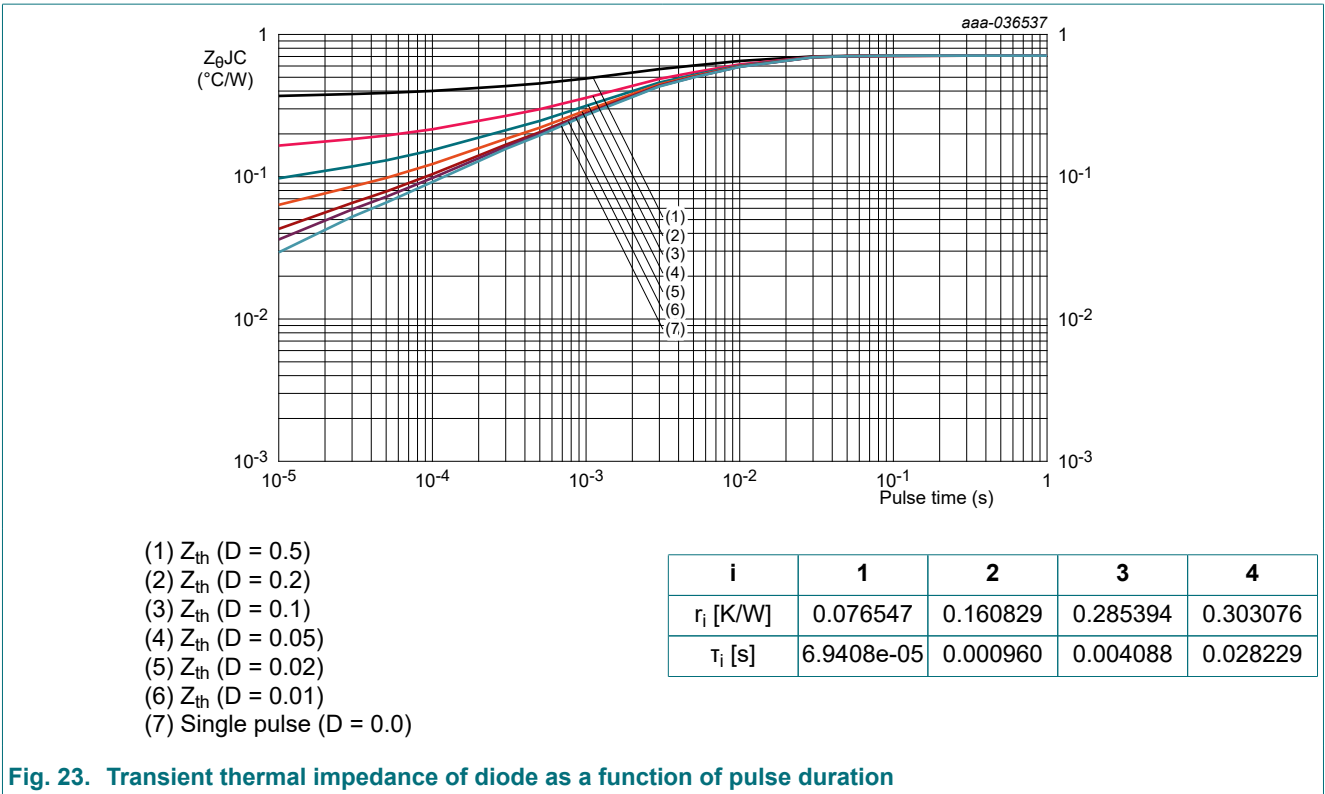

9.2. Waveforms

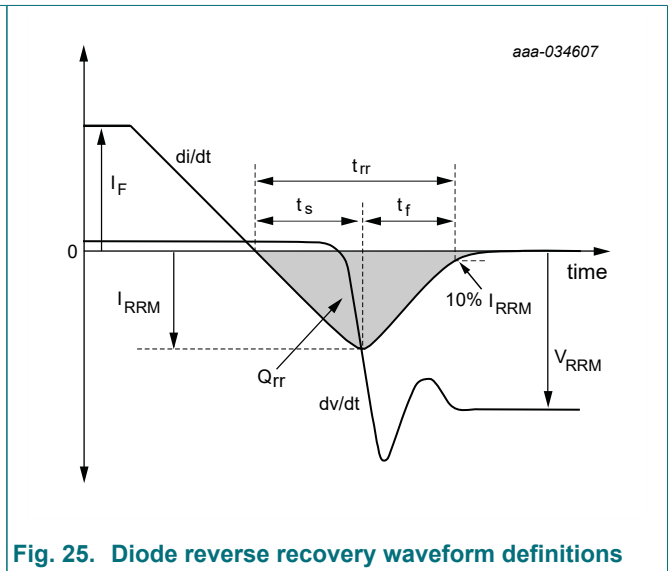
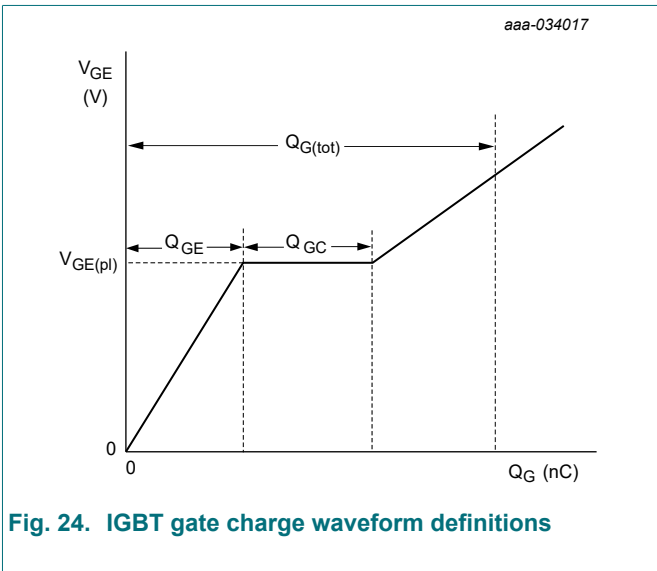

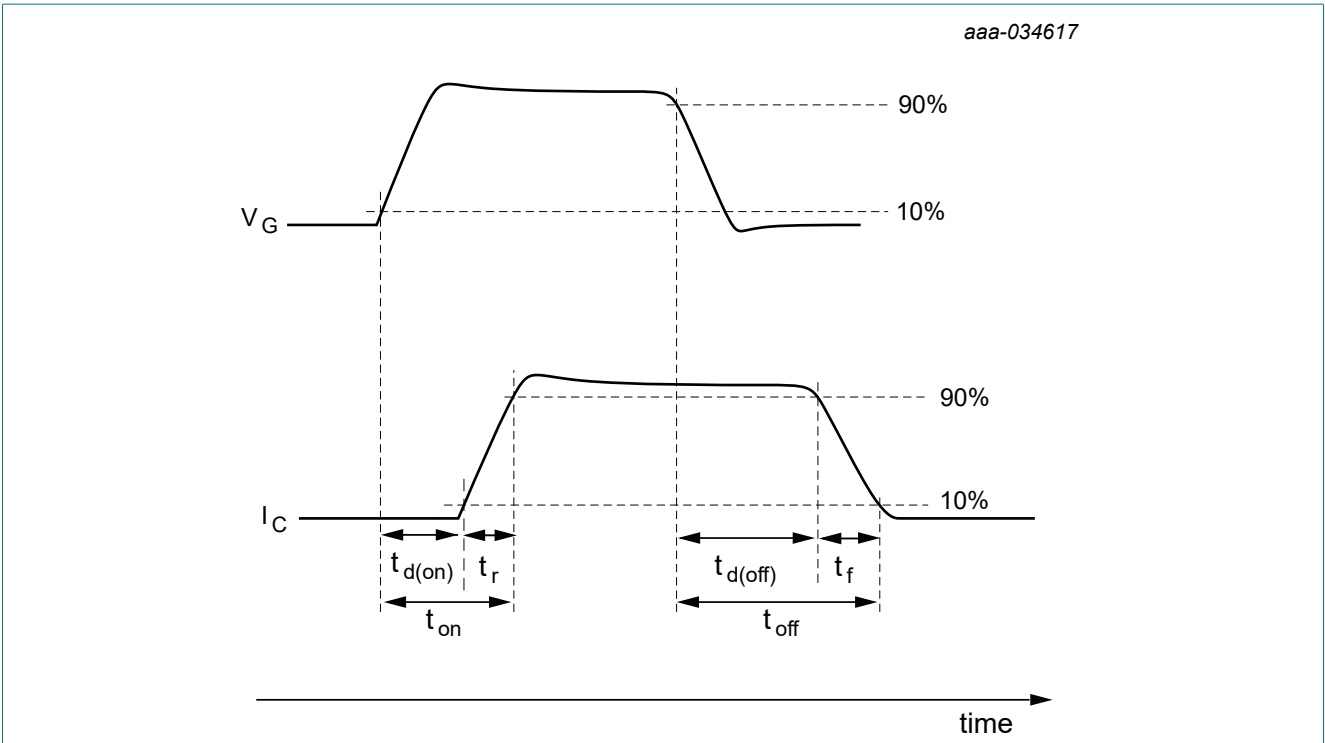

Fig. 26. IGBT switching times definitions

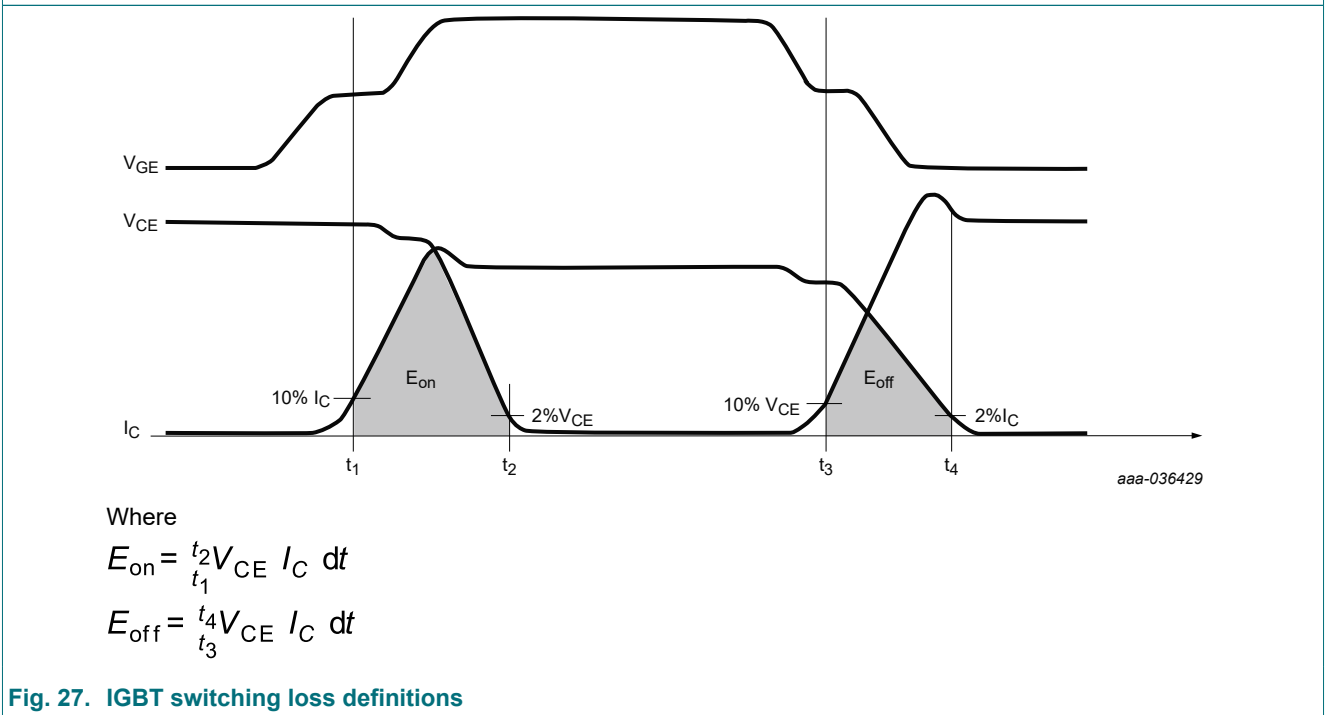

Fig. 27. IGBT switching loss definitions

10. Package outline

Plastic single-ended through-hole package; heatsink mounted; 1 mounting hole; 3-lead TO-247-3L

SOT429-2

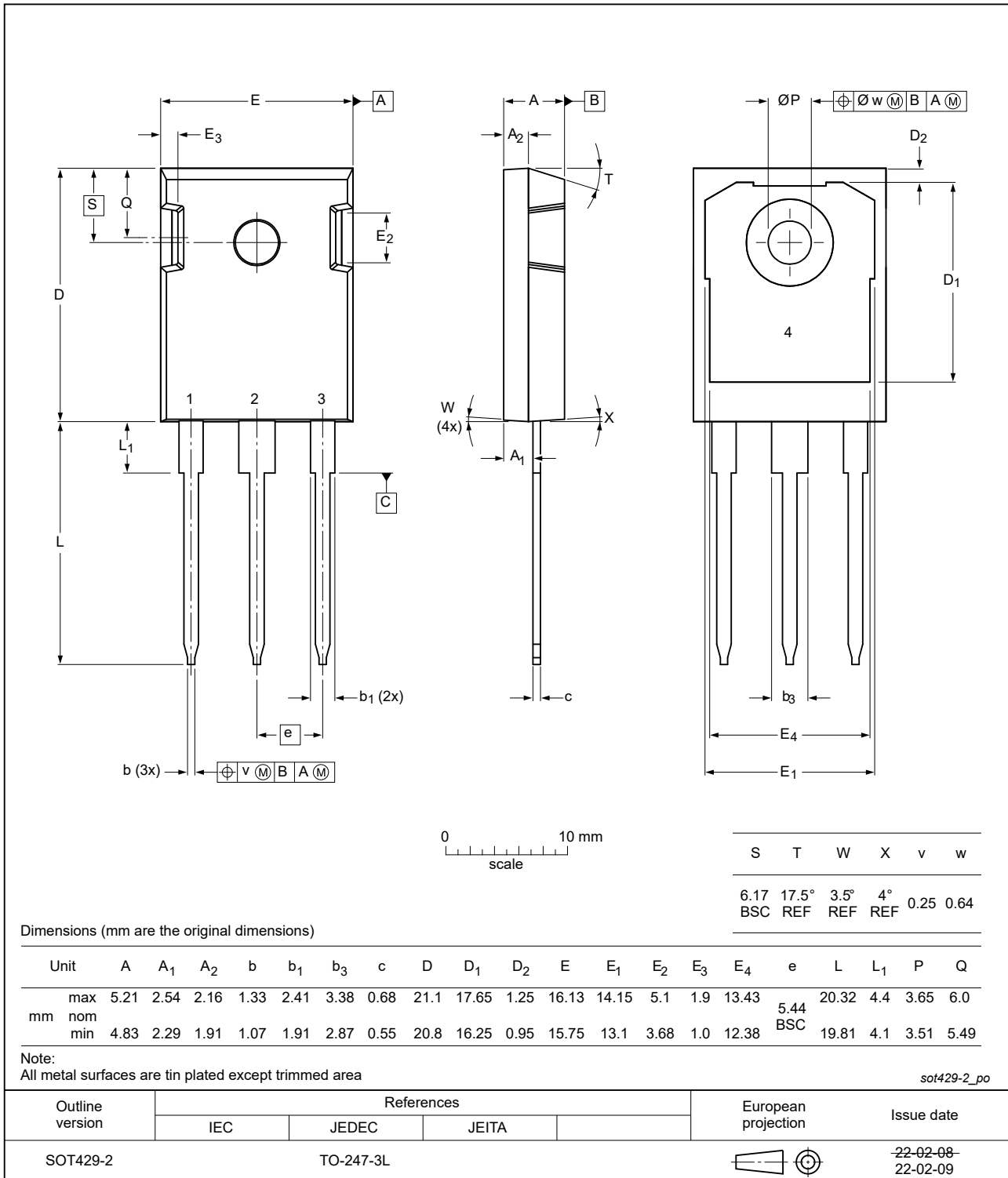

Fig. 28. Package outline TO-247-3L (SOT429-2)

11. Revision history

Table 8. Revision history

Document ID	Release date	Data sheet status	Change notice	Supersedes
NGW30T60M3DF v. 1	20230703	Product data sheet	-	-

12. Legal information

Data sheet status

Document status [1][2]	Product status [3]	Definition
Objective [short] data sheet	Development	This document contains data from the objective specification for product development.
Preliminary [short] data sheet	Qualification	This document contains data from the preliminary specification.
Product [short] data sheet	Production	This document contains the product specification.

- [1] Please consult the most recently issued document before initiating or completing a design.
- [2] The term 'short data sheet' is explained in section "Definitions".
- [3] The product status of device(s) described in this document may have changed since this document was published and may differ in case of multiple devices. The latest product status information is available on the internet at <https://www.nexperia.com>.

Definitions

Draft — The document is a draft version only. The content is still under internal review and subject to formal approval, which may result in modifications or additions. Nexperia does not give any representations or warranties as to the accuracy or completeness of information included herein and shall have no liability for the consequences of use of such information.

Short data sheet — A short data sheet is an extract from a full data sheet with the same product type number(s) and title. A short data sheet is intended for quick reference only and should not be relied upon to contain detailed and full information. For detailed and full information see the relevant full data sheet, which is available on request via the local Nexperia sales office. In case of any inconsistency or conflict with the short data sheet, the full data sheet shall prevail.

Product specification — The information and data provided in a Product data sheet shall define the specification of the product as agreed between Nexperia and its customer, unless Nexperia and customer have explicitly agreed otherwise in writing. In no event however, shall an agreement be valid in which the Nexperia product is deemed to offer functions and qualities beyond those described in the Product data sheet.

Disclaimers

Limited warranty and liability — Information in this document is believed to be accurate and reliable. However, Nexperia does not give any representations or warranties, expressed or implied, as to the accuracy or completeness of such information and shall have no liability for the consequences of use of such information. Nexperia takes no responsibility for the content in this document if provided by an information source outside of Nexperia.

In no event shall Nexperia be liable for any indirect, incidental, punitive, special or consequential damages (including - without limitation - lost profits, lost savings, business interruption, costs related to the removal or replacement of any products or rework charges) whether or not such damages are based on tort (including negligence), warranty, breach of contract or any other legal theory.

Notwithstanding any damages that customer might incur for any reason whatsoever, Nexperia's aggregate and cumulative liability towards customer for the products described herein shall be limited in accordance with the Terms and conditions of commercial sale of Nexperia.

Right to make changes — Nexperia reserves the right to make changes to information published in this document, including without limitation specifications and product descriptions, at any time and without notice. This document supersedes and replaces all information supplied prior to the publication hereof.

Suitability for use — Nexperia products are not designed, authorized or warranted to be suitable for use in life support, life-critical or safety-critical systems or equipment, nor in applications where failure or malfunction of an Nexperia product can reasonably be expected to result in personal

injury, death or severe property or environmental damage. Nexperia and its suppliers accept no liability for inclusion and/or use of Nexperia products in such equipment or applications and therefore such inclusion and/or use is at the customer's own risk.

Quick reference data — The Quick reference data is an extract of the product data given in the Limiting values and Characteristics sections of this document, and as such is not complete, exhaustive or legally binding.

Applications — Applications that are described herein for any of these products are for illustrative purposes only. Nexperia makes no representation or warranty that such applications will be suitable for the specified use without further testing or modification.

Customers are responsible for the design and operation of their applications and products using Nexperia products, and Nexperia accepts no liability for any assistance with applications or customer product design. It is customer's sole responsibility to determine whether the Nexperia product is suitable and fit for the customer's applications and products planned, as well as for the planned application and use of customer's third party customer(s). Customers should provide appropriate design and operating safeguards to minimize the risks associated with their applications and products.

Nexperia does not accept any liability related to any default, damage, costs or problem which is based on any weakness or default in the customer's applications or products, or the application or use by customer's third party customer(s). Customer is responsible for doing all necessary testing for the customer's applications and products using Nexperia products in order to avoid a default of the applications and the products or of the application or use by customer's third party customer(s). Nexperia does not accept any liability in this respect.

Limiting values — Stress above one or more limiting values (as defined in the Absolute Maximum Ratings System of IEC 60134) will cause permanent damage to the device. Limiting values are stress ratings only and (proper) operation of the device at these or any other conditions above those given in the Recommended operating conditions section (if present) or the Characteristics sections of this document is not warranted. Constant or repeated exposure to limiting values will permanently and irreversibly affect the quality and reliability of the device.

Terms and conditions of commercial sale — Nexperia products are sold subject to the general terms and conditions of commercial sale, as published at <http://www.nexperia.com/profile/terms>, unless otherwise agreed in a valid written individual agreement. In case an individual agreement is concluded only the terms and conditions of the respective agreement shall apply. Nexperia hereby expressly objects to applying the customer's general terms and conditions with regard to the purchase of Nexperia products by customer.

No offer to sell or license — Nothing in this document may be interpreted or construed as an offer to sell products that is open for acceptance or the grant, conveyance or implication of any license under any copyrights, patents or other industrial or intellectual property rights.

Export control — This document as well as the item(s) described herein may be subject to export control regulations. Export might require a prior authorization from competent authorities.

Non-automotive qualified products — Unless this data sheet expressly states that this specific Nexperia product is automotive qualified, the product is not suitable for automotive use. It is neither qualified nor tested in accordance with automotive testing or application requirements. Nexperia accepts no liability for inclusion and/or use of non-automotive qualified products in automotive equipment or applications.

In the event that customer uses the product for design-in and use in automotive applications to automotive specifications and standards, customer (a) shall use the product without Nexperia's warranty of the product for such automotive applications, use and specifications, and (b) whenever customer uses the product for automotive applications beyond Nexperia's specifications such use shall be solely at customer's own risk, and (c) customer fully indemnifies Nexperia for any liability, damages or failed product claims resulting from customer design and use of the product for automotive applications beyond Nexperia's standard warranty and Nexperia's product specifications.

Translations — A non-English (translated) version of a document is for reference only. The English version shall prevail in case of any discrepancy between the translated and English versions.

Trademarks

Notice: All referenced brands, product names, service names and trademarks are the property of their respective owners.

Contents

1. General description	1
2. Features and benefits	1
3. Applications	1
4. Quick reference data	1
5. Pinning information	2
6. Ordering information	2
7. Limiting values	2
8. Thermal characteristics	3
9. Characteristics	3
9.1. Output characteristics.....	5
9.2. Waveforms.....	11
10. Package outline	13
11. Revision history	14
12. Legal information	15

© Nexperia B.V. 2023. All rights reserved

For more information, please visit: <http://www.nexperia.com>

For sales office addresses, please send an email to: salesaddresses@nexperia.com

Date of release: 3 July 2023
