

MOSFET – N-Channel, Shielded Gate POWERTRENCH®

100 V, 128 A, 4.5 mΩ

FDP4D5N10C, FDPF4D5N10C

Description

This N-Channel MV MOSFET is produced using onsemi's advanced PowerTrench process that incorporates Shielded Gate technology. This Process has been Optimized to minimize on-state resistance and yet maintain superior switching performance with best in class soft body diode.

Features

- Max $R_{DS(on)}$ = 4.5 mΩ at $V_{GS} = 10\text{ V}$, $I_D = 100\text{ A}$
- Extremely Low Reverse Recovery Charge, Q_{rr}
- 100% UIL Tested
- This Device is Pb-Free Halide, Free and RoHS Compliant.

Applications

- Synchronous Rectification for ATX / Server / Telecom PSU
- Motor Drives and Uninterruptible Power Supplies
- Micro Solar Inverter

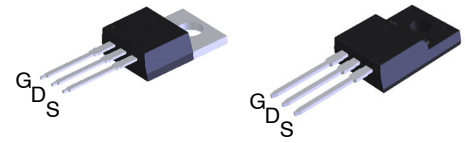

TO-220
 CASE 221A

TO-220 Fullpack, 3-Lead
 / TO-220F-3SG
 CASE 221AT

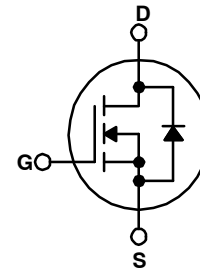

MARKING DIAGRAM

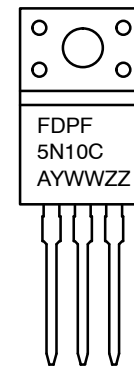

FDPF4D5N10C,
 FQD45N10C = Specific Device Code
 A = Assembly Location
 YWW = Date Code (Year and Week)
 ZZ = Assembly Lot Code

ORDERING INFORMATION

Device	Package	Shipping†
FDPF4D5N10C	TO-220F (Pb-Free)	1000 Units / Tube
FDP4D5N10C	TO-220 (Pb-Free)	800 Units / Tube

†For information on tape and reel specifications, including part orientation and tape sizes, please refer to our Tape and Reel Packaging Specifications Brochure, [BRD8011/D](#).

FDP4D5N10C,

MOSFET MAXIMUM RATINGS (T_C = 25°C unless otherwise noted.)

Symbol	Parameter	Ratings		Units
		FDP4D5N10C	FDPF4D5N10C	
V _{DS}	Drain to Source Voltage	100	100	V
V _{GS}	Gate to Source Voltage	±20	±20	V
I _D	Drain Current – Continuous (T _C = 25°C) (Note 3) – Continuous (T _C = 100°C) (Note 3) – Pulsed (Note 1)	128* 91 512	128* 91 512	A
E _{AS}	Single Pulsed–Avalanche Energy (Note 2)	486		mJ
P _D	Power Dissipation (T _C = 25°C)	150	37.5	W
	Power Dissipation (T _A = 25°C)	2.4	2.4	
T _J , T _{STG}	Operating and Storage Temperature Range	–55 to +175	–55 to +175	°C

*Drain current limited by maximum junction temperature. Package limitation current is 120 A.
Stresses exceeding those listed in the Maximum Ratings table may damage the device. If any of these limits are exceeded, device functionality should not be assumed, damage may occur and reliability may be affected.

THERMAL CHARACTERISTICS

Symbol	Parameter	FDP4D5N10C	FDPF4D5N10C	Units
R _{θJC}	Thermal Resistance, Junction to Case	1.0	4.0	°C/W
R _{θJA}	Thermal Resistance, Junction to Ambient	62.5	62.5	

ELECTRICAL CHARACTERISTICS (T_J = 25°C unless otherwise noted)

Symbol	Parameter	Test Conditions	Min	Typ	Max	Unit
Off Characteristics						
BV _{DSS}	Drain to Source Breakdown Voltage	I _D = 250 μA, V _{GS} = 0 V	100	–	–	V
$\frac{\Delta BV_{DSS}}{\Delta T_J}$	Breakdown Voltage Temperature Coefficient	I _D = 250 μA, Referenced to 25°C	–	53	–	mV/°C
I _{DSS}	Zero Gate Voltage Drain Current	V _{DS} = 80 V, V _{GS} = 0 V	–	–	1	μA
		V _{DS} = 80 V, T _J = 150°C	–	–	500	μA
I _{GSS}	Gate to Source Leakage Current	V _{GS} = ±20 V, V _{DS} = 0 V	–	–	±100	nA
On Characteristics						
V _{GS(th)}	Gate to Source Threshold Voltage	V _{GS} = V _{DS} , I _D = 310 μA	2.0	3.2	4.0	V
R _{DS(on)}	Static Drain to Source On–Resistance	V _{GS} = 10 V, I _D = 100 A	–	4.0	4.5	mΩ
g _{FS}	Forward Transconductance	V _{DS} = 5 V, I _D = 100 A	–	134	–	S
Dynamic Characteristics						
C _{iss}	Input Capacitance	V _{DS} = 50 V, V _{GS} = 0 V, f = 1 MHz	–	3615	5065	pF
C _{oss}	Output Capacitance		–	2330	3265	pF
C _{rss}	Reverse Transfer Capacitance		–	18	35	pF
R _g	Gate Resistance		0.1	1.1	2.2	S
Switching Characteristics						
t _{d(on)}	Turn–On Delay Time	V _{DD} = 50 V, I _D = 100 A, V _{GS} = 10 V, R _{GEN} = 6 Ω	–	29	47	ns
t _r	Rise Time		–	49	79	ns
t _{d(off)}	Turn–Off Delay Time		–	41	66	ns
t _f	Fall Time		–	13	24	ns
Q _g	Total Gate Charge	V _{GS} = 0 V to 10 V V _{DD} = 50 V, I _D = 100 A	–	48	68	nC
Q _{gs}	Gate to Source Gate Charge		–	19	–	nC
Q _{gd}	Gate to Drain “Miller” Charge		–	9	–	nC
Q _{oss}	Output Charge	V _{DD} = 50 V, V _{GS} = 0 V	–	150	–	nC

FDP4D5N10C,

ELECTRICAL CHARACTERISTICS (continued) ($T_J = 25^\circ\text{C}$ unless otherwise noted)

Symbol	Parameter	Test Conditions	Min	Typ	Max	Unit
Drain-Source Diode Characteristics						
I_S	Maximum Continuous Drain to Source Diode Forward Current		-	-	128	A
I_{SM}	Maximum Pulsed Drain to Source Diode Forward Current		-	-	512	A
V_{SD}	Source to Drain Diode Forward Voltage	$V_{GS} = 0\text{ V}, I_S = 100\text{ A}$	-	1.0	1.3	V
t_{rr}	Reverse Recovery Time	$V_{GS} = 0\text{ V}, V_{DD} = 50\text{ V},$ $I_F = 100\text{ A}, dI_F/dt = 100\text{ A}/\mu\text{s}$	-	82	132	ns
Q_{rr}	Reverse Recovery Charge		-	106	170	nC
t_{rr}	Reverse Recovery Time	$V_{GS} = 0\text{ V}, V_{DD} = 50\text{ V},$ $I_F = 100\text{ A}, dI_F/dt = 300\text{ A}/\mu\text{s}$	-	71	114	ns
Q_{rr}	Reverse Recovery Charge		-	258	413	nC

Product parametric performance is indicated in the Electrical Characteristics for the listed test conditions, unless otherwise noted. Product performance may not be indicated by the Electrical Characteristics if operated under different conditions.

NOTES:

1. Pulsed I_d please refer to Figure "Forward Bias Safe Operating Area" for more details.
2. E_{AS} of 486 mJ is based on starting $T_J = 25^\circ\text{C}$, $L = 3\text{ mH}$, $I_{AS} = 18\text{ A}$, $V_{DD} = 100\text{ V}$, $V_{GS} = 10\text{ V}$. 100% test at $L = 0.1\text{ mH}$, $I_{AS} = 58\text{ A}$.
3. Computed continuous current limited to Max Junction Temperature only, actual continuous current will be limited by thermal & electro-mechanical application board design.

FDP4D5N10C,

TYPICAL CHARACTERISTICS ($T_J = 25^\circ\text{C}$ unless otherwise noted)

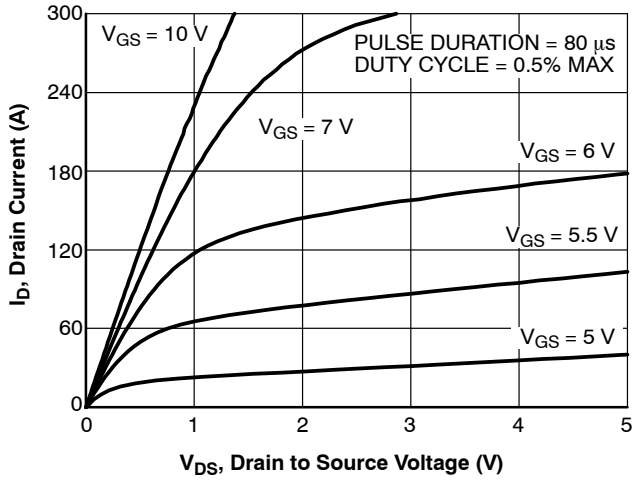

Figure 1. On-Region Characteristics

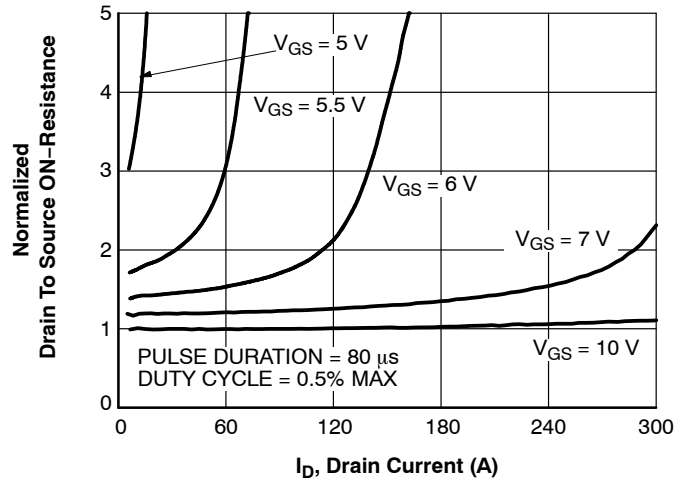

Figure 2. Normalized On-Resistance vs. Drain Current and Gate Voltage

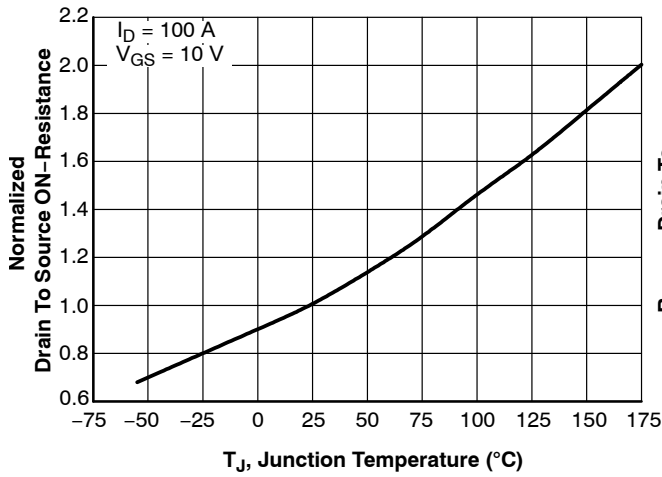

Figure 3. Normalized On Resistance vs. Junction Temperature

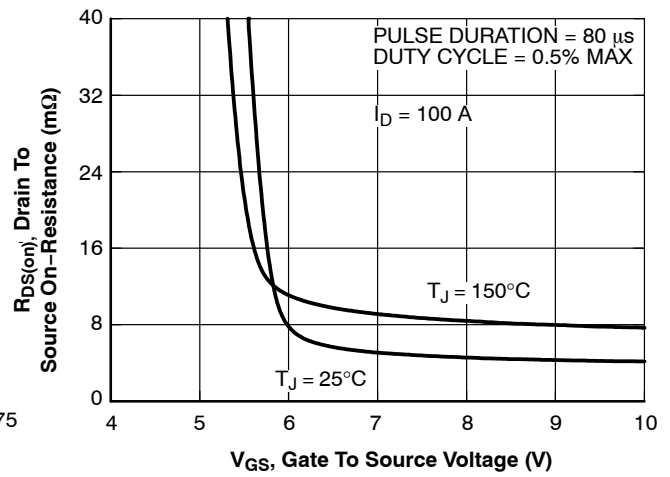

Figure 4. On-Resistance vs. Gate to Source Voltage

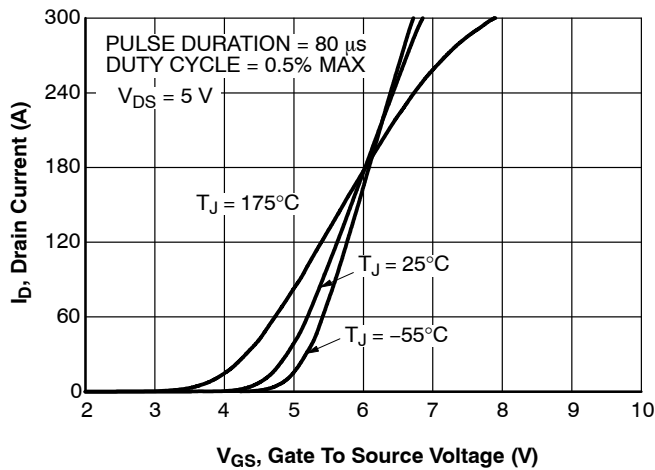

Figure 5. Transfer Characteristics

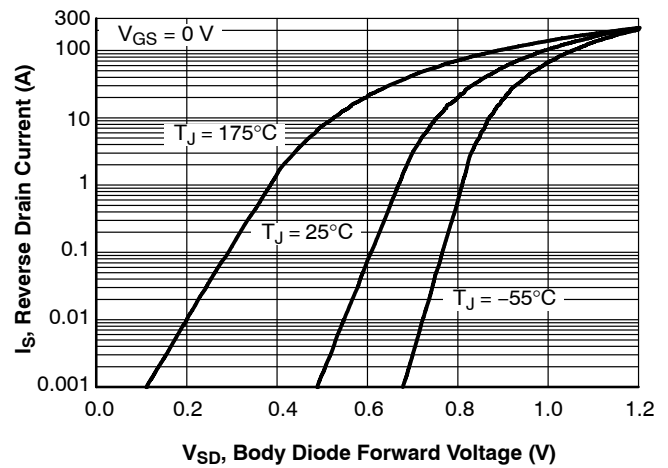

Figure 6. Source to Drain Diode Forward Voltage vs. Source Current

FDP4D5N10C,

TYPICAL CHARACTERISTICS (CONTINUED) ($T_J = 25^\circ\text{C}$ unless otherwise noted)

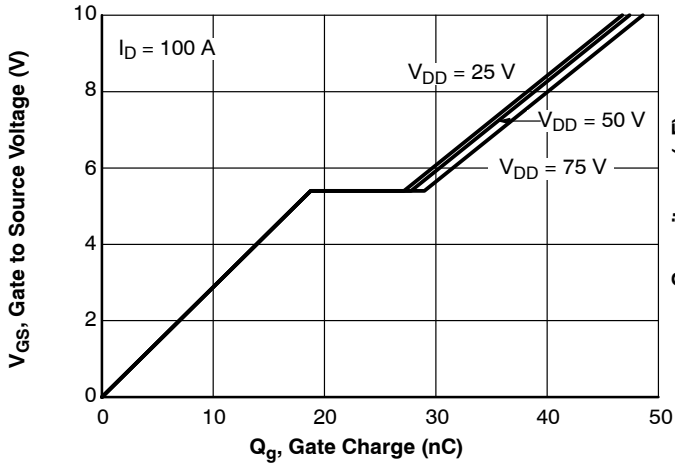

Figure 7. Gate Charge Characteristics

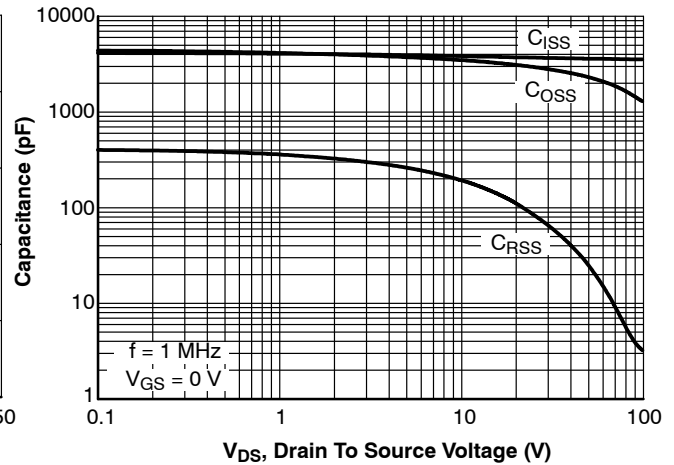

Figure 8. Capacitance vs Drain to Source Voltage

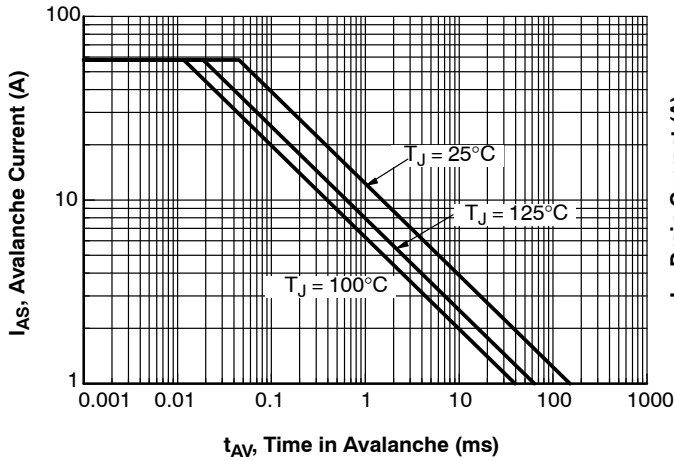

Figure 9. Unclamped Inductive Switching Capability

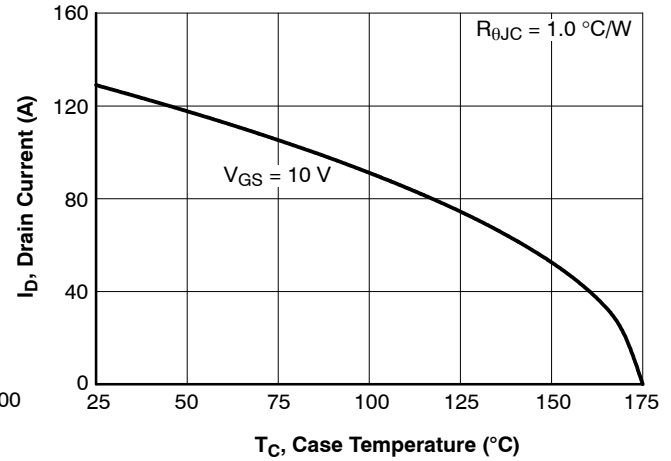

Figure 10. Maximum Continuous Drain Current vs. Case Temperature

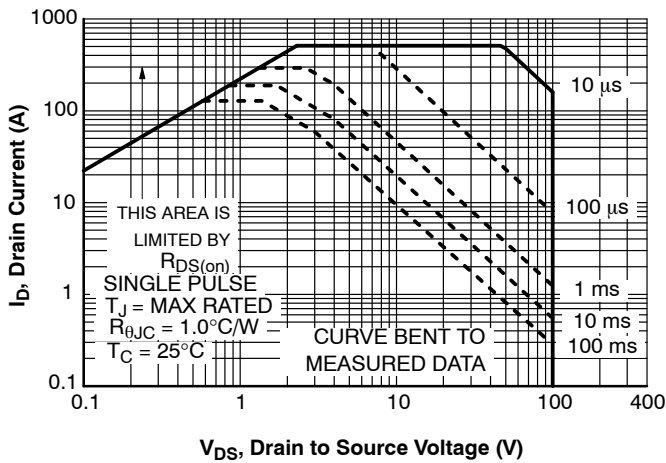

Figure 11. Forward Bias Safe Operating Area for FDP4D5N10C

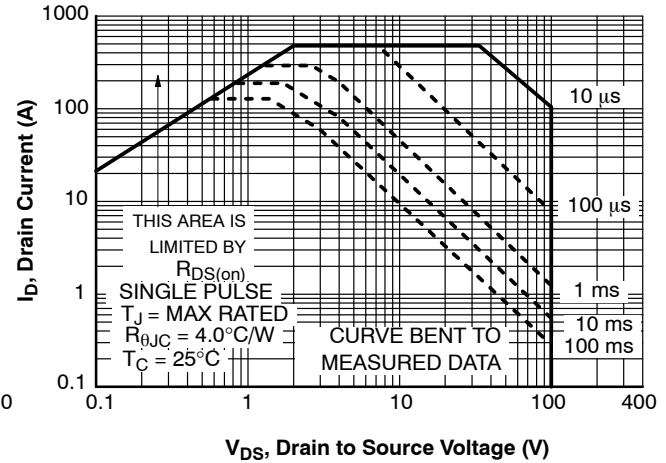

Figure 12. Forward Bias Safe Operating Area for FDP4D5N10C

FDP4D5N10C,

TYPICAL CHARACTERISTICS (CONTINUED) ($T_J = 25^\circ\text{C}$ unless otherwise noted)

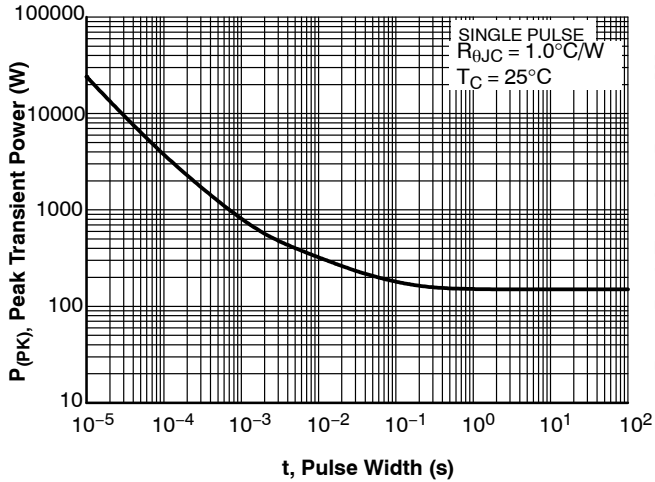

Figure 13. Single Pulse Maximum Power Dissipation for FDP4D5N10C

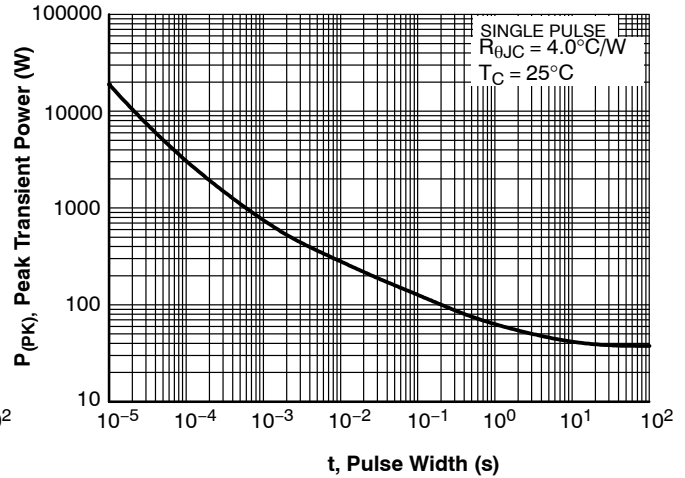

Figure 14. Single Pulse Maximum Power Dissipation for FDP4D5N10C

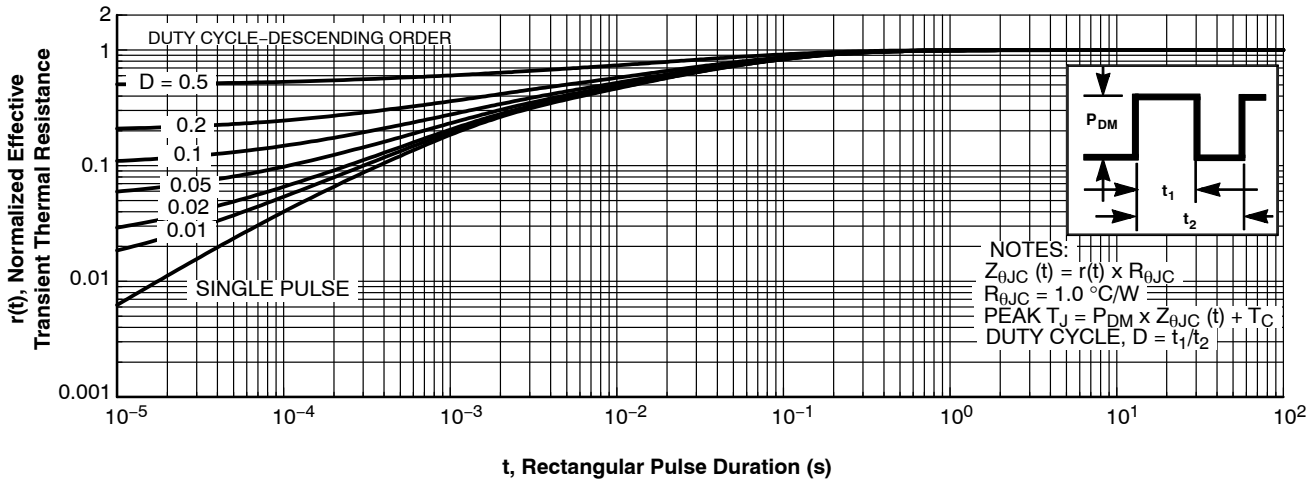

Figure 15. Junction-to-Case Transient Thermal Response Curve for FDP4D5N10C

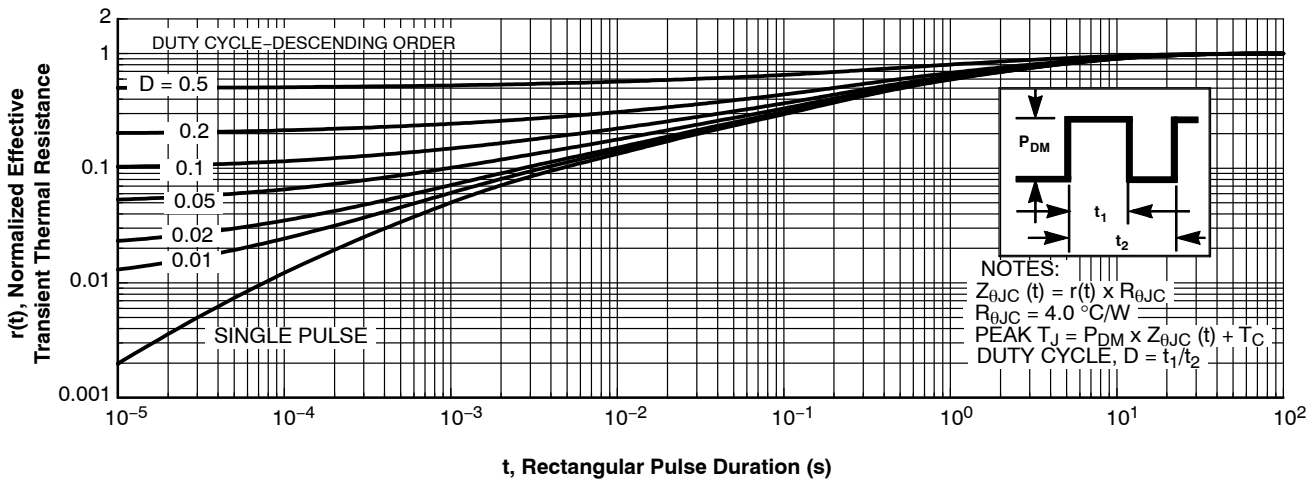
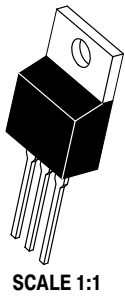

Figure 16. Junction-to-Case Transient Thermal Response Curve for FDP4D5N10C

MECHANICAL CASE OUTLINE PACKAGE DIMENSIONS



TO-220 CASE 221A ISSUE AK

DATE 13 JAN 2022

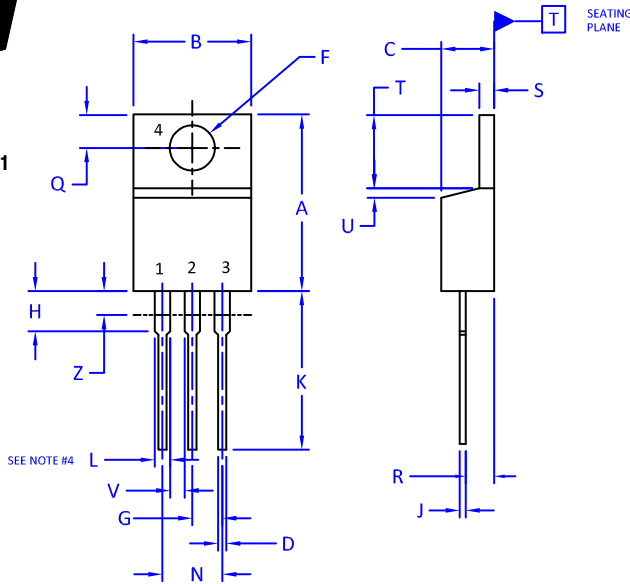

NOTES:

1. DIMENSIONING AND TOLERANCING PER ANSI Y14.5M, 2009.
2. CONTROLLING DIMENSION: INCHES
3. DIMENSION Z DEFINES A ZONE WHERE ALL BODY AND LEAD IRREGULARITIES ARE ALLOWED.
4. MAX WIDTH FOR F102 DEVICE = 1.35MM

DIM	INCHES		MILLIMETERS	
	MIN.	MAX.	MIN.	MAX.
A	0.570	0.620	14.48	15.75
B	0.380	0.415	9.66	10.53
C	0.160	0.190	4.07	4.83
D	0.025	0.038	0.64	0.96
F	0.142	0.161	3.60	4.09
G	0.095	0.105	2.42	2.66
H	0.110	0.161	2.80	4.10
J	0.014	0.024	0.36	0.61
K	0.500	0.562	12.70	14.27
L	0.045	0.060	1.15	1.52
N	0.190	0.210	4.83	5.33
Q	0.100	0.120	2.54	3.04
R	0.080	0.110	2.04	2.79
S	0.045	0.055	1.15	1.41
T	0.235	0.255	5.97	6.47
U	0.000	0.050	0.00	1.27
V	0.045	---	1.15	---
Z	---	0.080	---	2.04

STYLE 1:

- PIN 1. BASE
- 2. COLLECTOR
- 3. EMITTER
- 4. COLLECTOR

STYLE 2:

- PIN 1. BASE
- 2. EMITTER
- 3. COLLECTOR
- 4. EMITTER

STYLE 3:

- PIN 1. CATHODE
- 2. ANODE
- 3. GATE
- 4. ANODE

STYLE 4:

- PIN 1. MAIN TERMINAL 1
- 2. MAIN TERMINAL 2
- 3. GATE
- 4. MAIN TERMINAL 2

STYLE 5:

- PIN 1. GATE
- 2. DRAIN
- 3. SOURCE
- 4. DRAIN

STYLE 6:

- PIN 1. ANODE
- 2. CATHODE
- 3. ANODE
- 4. CATHODE

STYLE 7:

- PIN 1. CATHODE
- 2. ANODE
- 3. CATHODE
- 4. ANODE

STYLE 8:

- PIN 1. CATHODE
- 2. ANODE
- 3. EXTERNAL TRIP/DELAY
- 4. ANODE

STYLE 9:

- PIN 1. GATE
- 2. COLLECTOR
- 3. EMITTER
- 4. COLLECTOR

STYLE 10:

- PIN 1. GATE
- 2. SOURCE
- 3. DRAIN
- 4. SOURCE

STYLE 11:

- PIN 1. DRAIN
- 2. SOURCE
- 3. GATE
- 4. SOURCE

STYLE 12:

- PIN 1. MAIN TERMINAL 1
- 2. MAIN TERMINAL 2
- 3. GATE
- 4. NOT CONNECTED

DOCUMENT NUMBER:	98ASB42148B	Electronic versions are uncontrolled except when accessed directly from the Document Repository. Printed versions are uncontrolled except when stamped "CONTROLLED COPY" in red.
DESCRIPTION:	TO-220	PAGE 1 OF 1

onsemi and onsemi are trademarks of Semiconductor Components Industries, LLC dba onsemi or its subsidiaries in the United States and/or other countries. onsemi reserves the right to make changes without further notice to any products herein. onsemi makes no warranty, representation or guarantee regarding the suitability of its products for any particular purpose, nor does onsemi assume any liability arising out of the application or use of any product or circuit, and specifically disclaims any and all liability, including without limitation special, consequential or incidental damages. onsemi does not convey any license under its patent rights nor the rights of others.

MECHANICAL CASE OUTLINE

PACKAGE DIMENSIONS

ON Semiconductor®



TO-220 Fullpack, 3-Lead / TO-220F-3SG
CASE 221AT
ISSUE B

DATE 19 JAN 2021

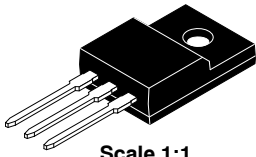

Scale 1:1

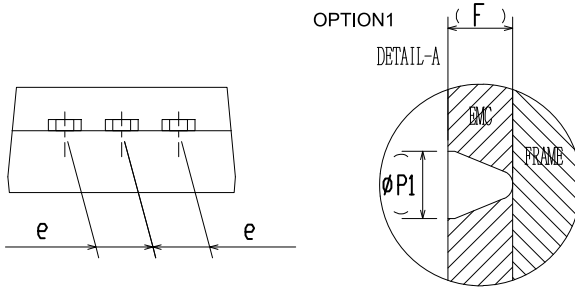
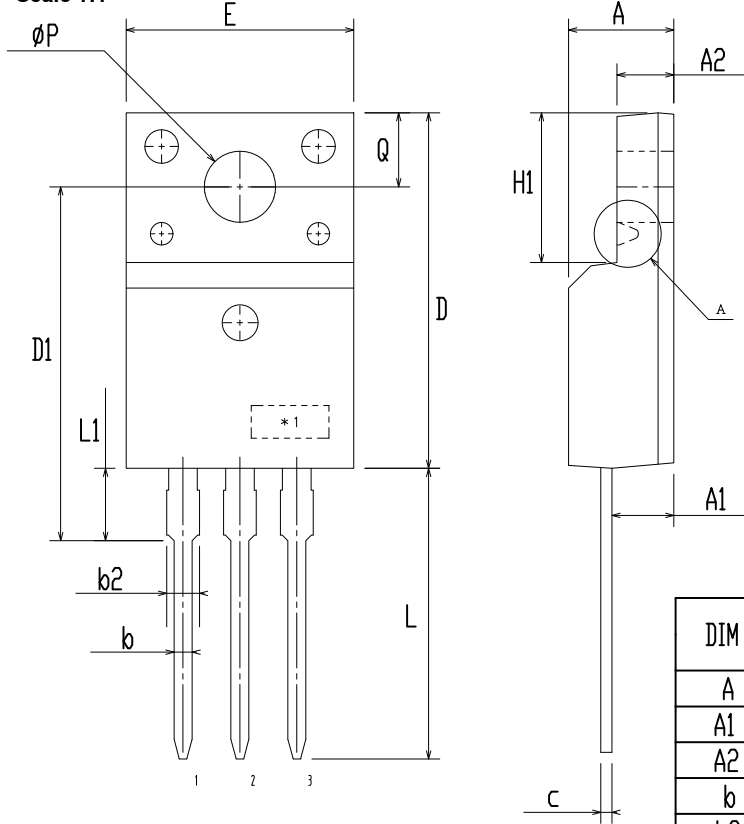

DIM	MILLIMETERS		
	MIN	NOM	MAX
A	4.50	4.70	4.90
A1	2.56	2.76	2.96
A2	2.34	2.54	2.74
b	0.70	0.80	0.90
b2	~	~	1.47
c	0.45	0.50	0.60
D	15.67	15.87	16.07
D1	15.60	15.80	16.00
E	9.96	10.16	10.36
e	2.34	2.54	2.74
F	~	0.84	~
H1	6.48	6.68	6.88
L	12.78	12.98	13.18
L1	3.03	3.23	3.43
∅ P	2.98	3.18	3.38
∅ P1	~	1.00	~
Q	3.20	3.30	3.40

NOTES:

- A. DIMENSION AND TOLERANCE AS ASME Y14.5-2009
- B. DIMENSIONS ARE EXCLUSIVE OF BURRS, MOLD FLASH AND TIE BAR PROTRUCTIONS.
- C. OPTION 1 - WITH SUPPORT PIN HOLE
- OPTION 2 - NO SUPPORT PIN HOLE

DOCUMENT NUMBER:	98AON67439E	Electronic versions are uncontrolled except when accessed directly from the Document Repository. Printed versions are uncontrolled except when stamped "CONTROLLED COPY" in red.
DESCRIPTION:	TO-220 FULLPACK, 3-LEAD / TO-220F-3SG	PAGE 1 OF 1

ON Semiconductor and are trademarks of Semiconductor Components Industries, LLC dba ON Semiconductor or its subsidiaries in the United States and/or other countries. ON Semiconductor reserves the right to make changes without further notice to any products herein. ON Semiconductor makes no warranty, representation or guarantee regarding the suitability of its products for any particular purpose, nor does ON Semiconductor assume any liability arising out of the application or use of any product or circuit, and specifically disclaims any and all liability, including without limitation special, consequential or incidental damages. ON Semiconductor does not convey any license under its patent rights nor the rights of others.

onsemi, **Onsemi**, and other names, marks, and brands are registered and/or common law trademarks of Semiconductor Components Industries, LLC dba "**onsemi**" or its affiliates and/or subsidiaries in the United States and/or other countries. **onsemi** owns the rights to a number of patents, trademarks, copyrights, trade secrets, and other intellectual property. A listing of **onsemi**'s product/patent coverage may be accessed at www.onsemi.com/site/pdf/Patent-Marking.pdf. **onsemi** reserves the right to make changes at any time to any products or information herein, without notice. The information herein is provided "as-is" and **onsemi** makes no warranty, representation or guarantee regarding the accuracy of the information, product features, availability, functionality, or suitability of its products for any particular purpose, nor does **onsemi** assume any liability arising out of the application or use of any product or circuit, and specifically disclaims any and all liability, including without limitation special, consequential or incidental damages. Buyer is responsible for its products and applications using **onsemi** products, including compliance with all laws, regulations and safety requirements or standards, regardless of any support or applications information provided by **onsemi**. "Typical" parameters which may be provided in **onsemi** data sheets and/or specifications can and do vary in different applications and actual performance may vary over time. All operating parameters, including "Typicals" must be validated for each customer application by customer's technical experts. **onsemi** does not convey any license under any of its intellectual property rights nor the rights of others. **onsemi** products are not designed, intended, or authorized for use as a critical component in life support systems or any FDA Class 3 medical devices or medical devices with a same or similar classification in a foreign jurisdiction or any devices intended for implantation in the human body. Should Buyer purchase or use **onsemi** products for any such unintended or unauthorized application, Buyer shall indemnify and hold **onsemi** and its officers, employees, subsidiaries, affiliates, and distributors harmless against all claims, costs, damages, and expenses, and reasonable attorney fees arising out of, directly or indirectly, any claim of personal injury or death associated with such unintended or unauthorized use, even if such claim alleges that **onsemi** was negligent regarding the design or manufacture of the part. **onsemi** is an Equal Opportunity/Affirmative Action Employer. This literature is subject to all applicable copyright laws and is not for resale in any manner.

ADDITIONAL INFORMATION

TECHNICAL PUBLICATIONS:

Technical Library: www.onsemi.com/design/resources/technical-documentation
onsemi Website: www.onsemi.com

ONLINE SUPPORT: www.onsemi.com/support

For additional information, please contact your local Sales Representative at www.onsemi.com/support/sales