

MOSFET – N-Channel, POWERTRENCH®

75 V, 235 A, 3.2 mΩ

FDA032N08

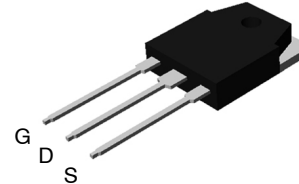

TO-3P-3LD / EIAJ SC-65, ISOLATED
CASE 340BZ

Description

This N-Channel MOSFET is produced using **onsemi**'s advanced POWERTRENCH process that has been tailored to minimize the on-state resistance while maintaining superior switching performance.

Features

- $R_{DS(on)} = 2.5 \text{ m}\Omega$ (Typ.) @ $V_{GS} = 10 \text{ V}$, $I_D = 75 \text{ A}$
- Fast Switching Speed
- Low Gate Charge
- High Performance Trench Technology for Extremely Low $R_{DS(on)}$
- High Power and Current Handling Capability
- RoHS Compliant

Applications

- Synchronous Rectification for ATX / Server / Telecom PSU
- Battery Protection Circuit
- Motor Drives and Uninterruptible Power Supplies

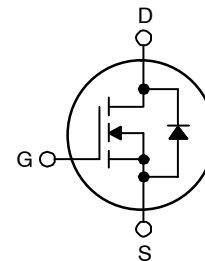

MARKING DIAGRAM

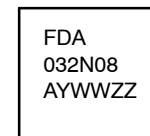

FDA032N08 = Specific Device Code
A = Assembly Location
YWW = Date Code (Year and Week)
ZZ = Assembly Lot

MOSFET MAXIMUM RATINGS ($T_C = 25^\circ\text{C}$ unless otherwise noted)

Symbol	Parameter	Value	Unit
V_{DSS}	Drain to Source Voltage	75	V
V_{GSS}	Gate to Source Voltage	± 20	V
I_D	Drain Current		A
	Continuous ($T_C = 25^\circ\text{C}$, Silicon Limited)	235	
	Continuous ($T_C = 100^\circ\text{C}$, Silicon Limited)	165	
	Continuous ($T_C = 25^\circ\text{C}$, Package Limited)	120	
I_{DM}	Drain Current – Pulsed (Note 1)	940	A
E_{AS}	Single Pulsed Avalanche Energy (Note 2)	1995	mJ
dv/dt	Peak Diode Recovery dv/dt (Note 3)	5.5	V/ns
P_D	Power Dissipation ($T_C = 25^\circ\text{C}$) – Derate above 25°C	375	W
		2.5	W/ $^\circ\text{C}$
T_J, T_{STG}	Operating and Storage Temperature Range	-55 to +175	$^\circ\text{C}$
T_L	Maximum Lead Temperature for Soldering, 1/8" from Case for 5 Seconds	300	$^\circ\text{C}$

Stresses exceeding those listed in the Maximum Ratings table may damage the device. If any of these limits are exceeded, device functionality should not be assumed, damage may occur and reliability may be affected.

ORDERING INFORMATION

Device	Package	Shipping
FDA032N08	TO-3P-3L (Pb-Free)	450 Units / Tube

FDA032N08

THERMAL CHARACTERISTICS

Symbol	Parameter	FDA032N08	Unit
$R_{\theta JC}$	Thermal Resistance, Junction-to-Case, Max	0.4	$^{\circ}\text{C}/\text{W}$
$R_{\theta JA}$	Thermal Resistance, Junction-to-Ambient, Max	40	$^{\circ}\text{C}/\text{W}$

ELECTRICAL CHARACTERISTICS ($T_C = 25^{\circ}\text{C}$, unless otherwise noted)

Symbol	Parameter	Test Conditions	Min	Typ	Max	Unit
OFF CHARACTERISTIC						
BV_{DSS}	Drain to Source Breakdown Voltage	$I_D = 250 \mu\text{A}$, $V_{GS} = 0 \text{V}$, $T_C = 25^{\circ}\text{C}$	75	-	-	V
$\Delta BV_{DSS} / \Delta T_J$	Breakdown Voltage Temperature Coefficient	$I_D = 250 \mu\text{A}$, Referenced to 25°C	-	0.05	-	$\text{V}/^{\circ}\text{C}$
I_{DSS}	Zero Gate Voltage Drain Current	$V_{DS} = 75 \text{V}$, $V_{GS} = 0 \text{V}$	-	-	1	μA
		$V_{DS} = 75 \text{V}$, $T_C = 150^{\circ}\text{C}$	-	-	10	
I_{GSS}	Gate to Body Leakage Current	$V_{GS} = \pm 20 \text{V}$, $V_{DS} = 0 \text{V}$	-	-	± 100	nA

ON CHARACTERISTICS

$V_{GS(th)}$	Gate Threshold Voltage	$V_{GS} = V_{DS}$, $I_D = 250 \mu\text{A}$	2.5	3.5	4.5	V
$R_{DS(on)}$	Static Drain to Source On-Resistance	$V_{GS} = 10 \text{V}$, $I_D = 75 \text{A}$	-	2.5	3.2	$\text{m}\Omega$
g_{FS}	Forward Transconductance	$V_{DS} = 20 \text{V}$, $I_D = 75 \text{A}$	-	180	-	S

DYNAMIC CHARACTERISTICS

C_{iss}	Input Capacitance	$V_{DS} = 25 \text{V}$, $V_{GS} = 0 \text{V}$, $f = 1 \text{MHz}$	-	11400	15160	pF
C_{oss}	Output Capacitance		-	1360	1810	pF
C_{rss}	Reverse Transfer Capacitance		-	595	800	pF
$Q_g(TOT)$	Total Gate Charge at 10 V	$V_{DS} = 60 \text{V}$, $I_D = 75 \text{A}$, $V_{GS} = 10 \text{V}$ (Note 4)	-	169	220	nC
Q_{gs}	Gate to Source Gate Charge		-	60	-	nC
Q_{gd}	Gate to Drain "Miller" Charge		-	47	-	nC

SWITCHING CHARACTERISTICS

$t_{d(on)}$	Turn-On Delay Time	$V_{DD} = 37.5 \text{V}$, $I_D = 75 \text{A}$, $R_G = 25 \Omega$, $V_{GS} = 10 \text{V}$ (Note 4)	-	230	470	ns
t_r	Turn-On Rise Time		-	191	392	ns
$t_{d(off)}$	Turn-Off Delay Time		-	335	680	ns
t_f	Turn-Off Fall Time		-	121	252	ns

DRAIN-SOURCE DIODE CHARACTERISTICS

I_S	Maximum Continuous Drain to Source Diode Forward Current	-	-	235	A	
I_{SM}	Maximum Pulsed Drain to Source Diode Forward Current	-	-	940	A	
V_{SD}	Drain to Source Diode Forward Voltage	$V_{GS} = 0 \text{V}$, $I_{SD} = 75 \text{A}$	-	-	1.3	V
t_{rr}	Reverse Recovery Time	$V_{GS} = 0 \text{V}$, $I_{SD} = 75 \text{A}$, $di/dt = 100 \text{A}/\mu\text{s}$	-	53	-	ns
Q_{rr}	Reverse Recovery Charge		-	77	-	nC

Product parametric performance is indicated in the Electrical Characteristics for the listed test conditions, unless otherwise noted. Product performance may not be indicated by the Electrical Characteristics if operated under different conditions.

1. Repetitive Rating: Pulse width limited by maximum junction temperature.
2. $L = 0.71 \text{mH}$, $I_{AS} = 75 \text{A}$, $V_{DD} = 50 \text{V}$, $R_G = 25 \Omega$, Starting $T_J = 25^{\circ}\text{C}$.
3. $I_{SD} \leq 75 \text{A}$, $di/dt \leq 200 \text{A}/\mu\text{s}$, $V_{DD} \leq BV_{DSS}$, Starting $T_J = 25^{\circ}\text{C}$.
4. Essentially independent of operating temperature typical characteristics.

TYPICAL PERFORMANCE CHARACTERISTICS

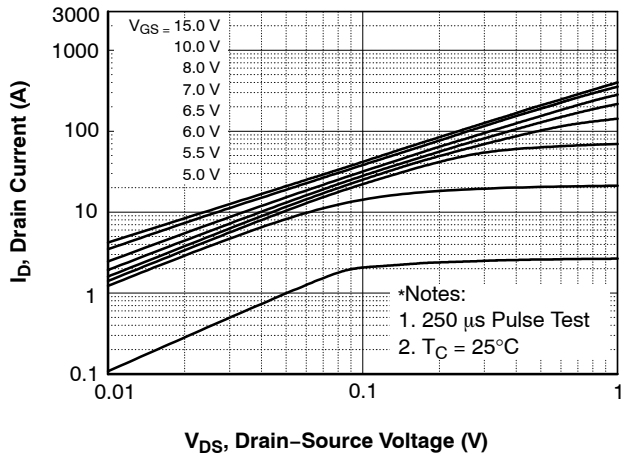

Figure 1. On-Region Characteristics

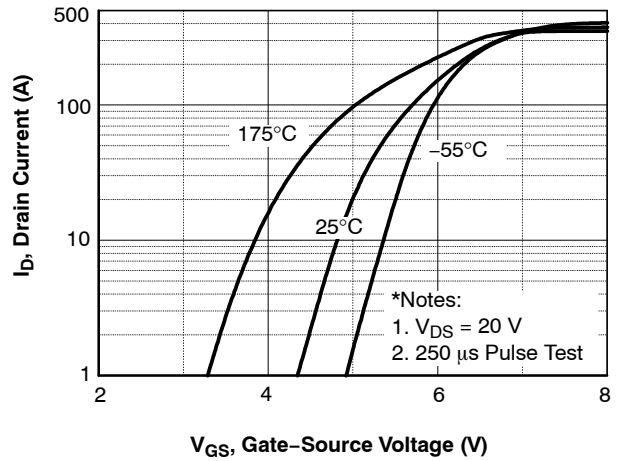

Figure 2. Transfer Characteristics

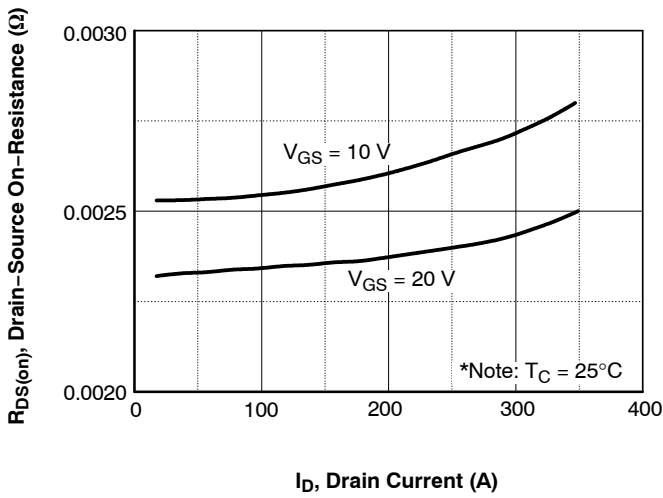

Figure 3. On-Resistance Variation vs. Drain Current and Gate Voltage

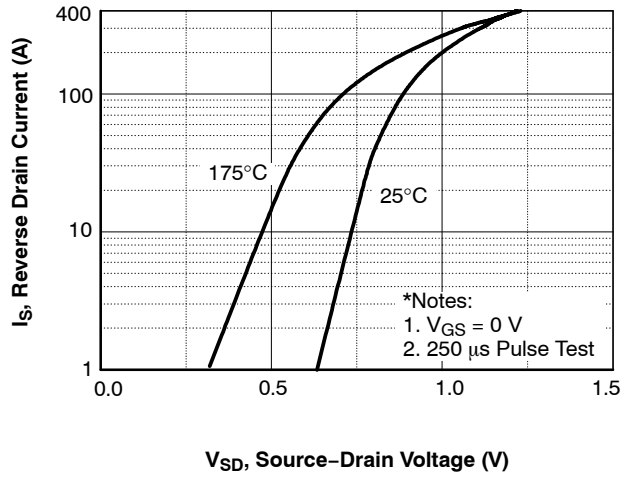

Figure 4. Body Diode Forward Voltage Variation vs. Source Current and Temperature

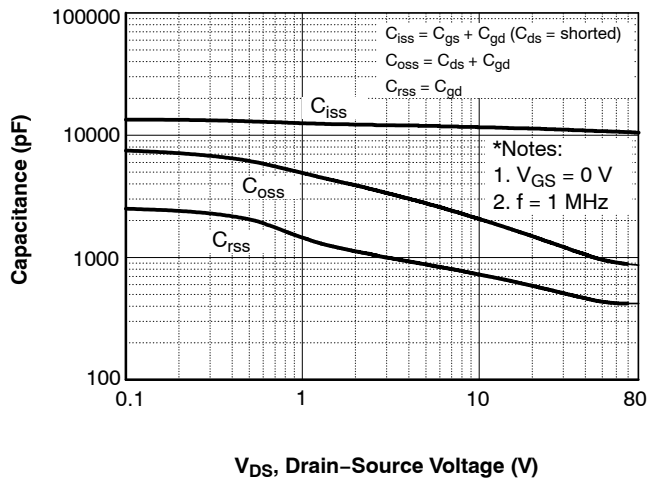

Figure 5. Capacitance Characteristics

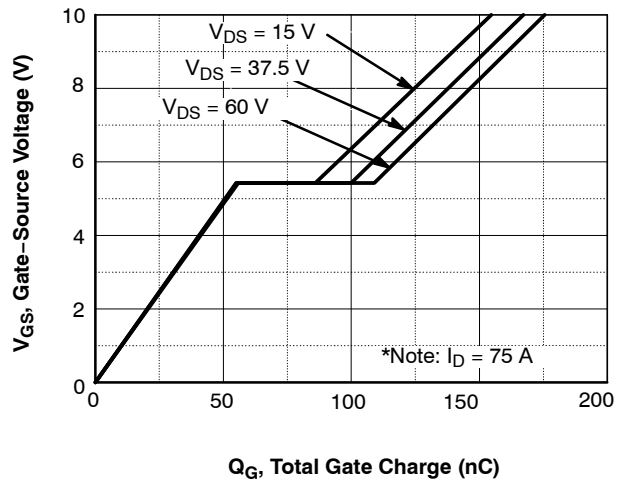

Figure 6. Gate Charge Characteristics

TYPICAL PERFORMANCE CHARACTERISTICS (continued)

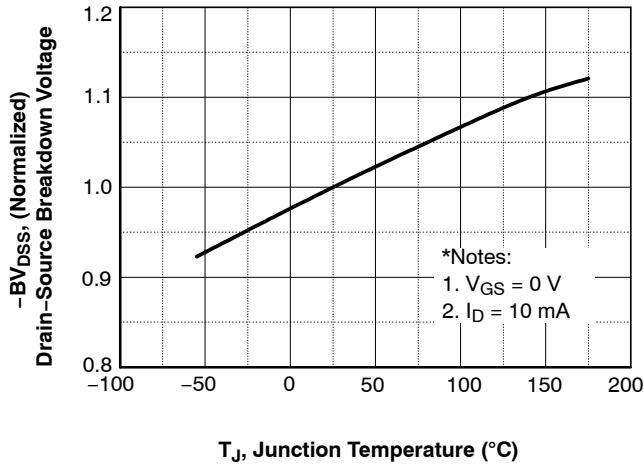

Figure 7. Breakdown Voltage Variation vs. Temperature

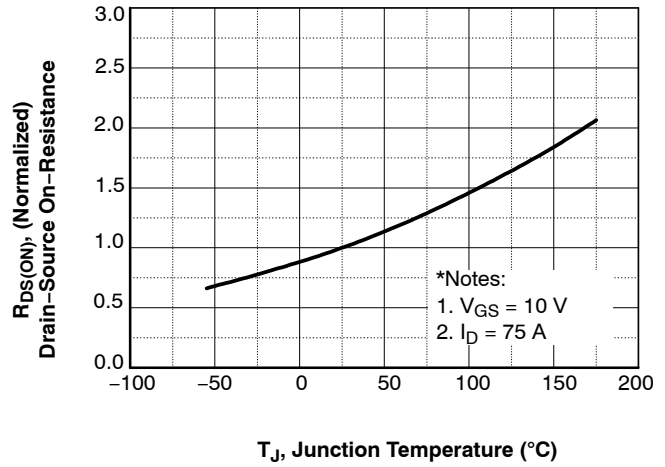

Figure 8. On-Resistance Variation vs. Temperature

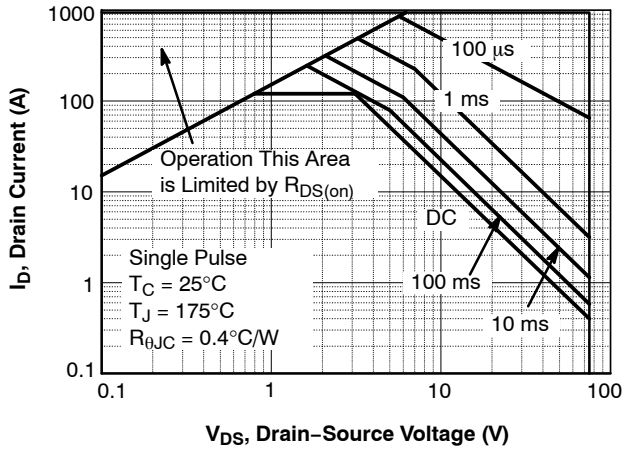

Figure 9. Maximum Safe Operating Area

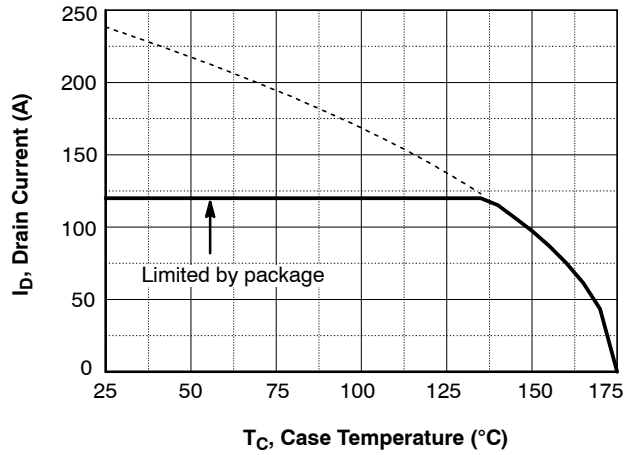

Figure 10. Maximum Drain Current vs. Case Temperature

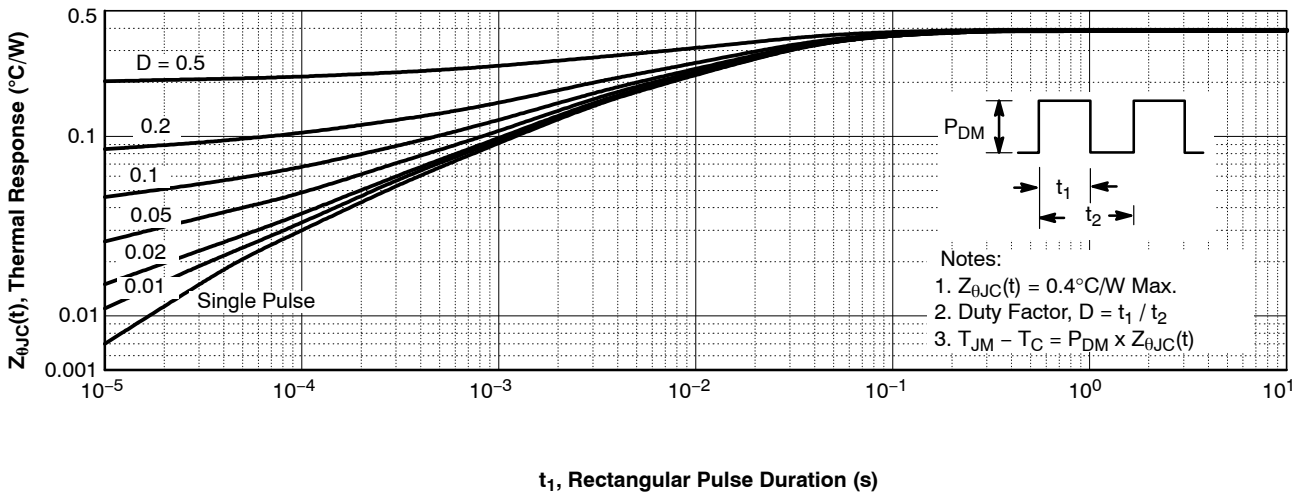

Figure 11. Transient Thermal Response Curve

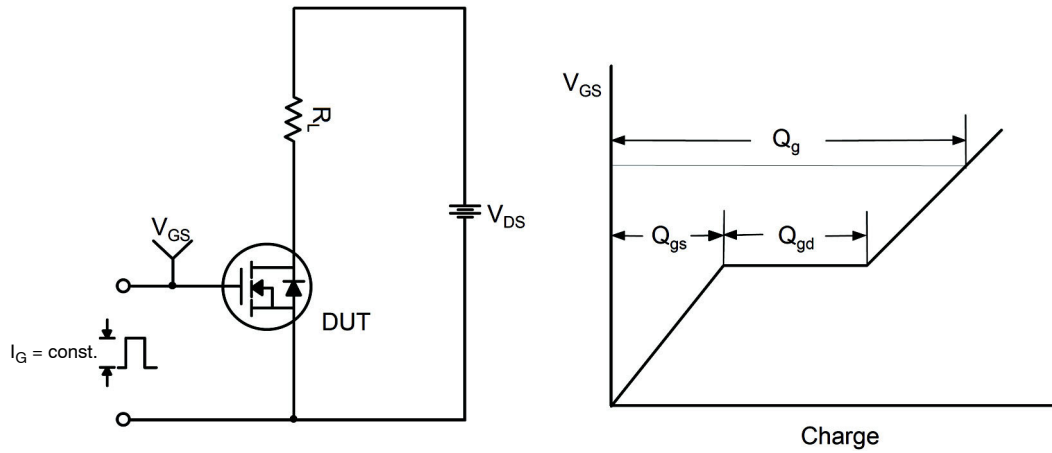

Figure 12. Gate Charge Test Circuit & Waveform

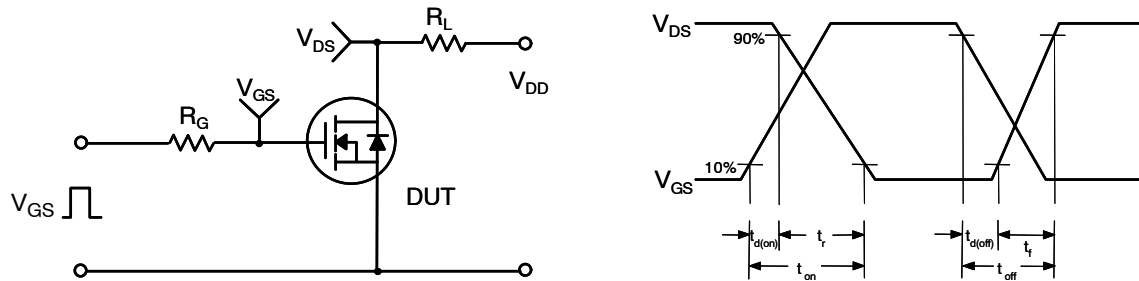

Figure 13. Resistive Switching Test Circuit & Waveforms

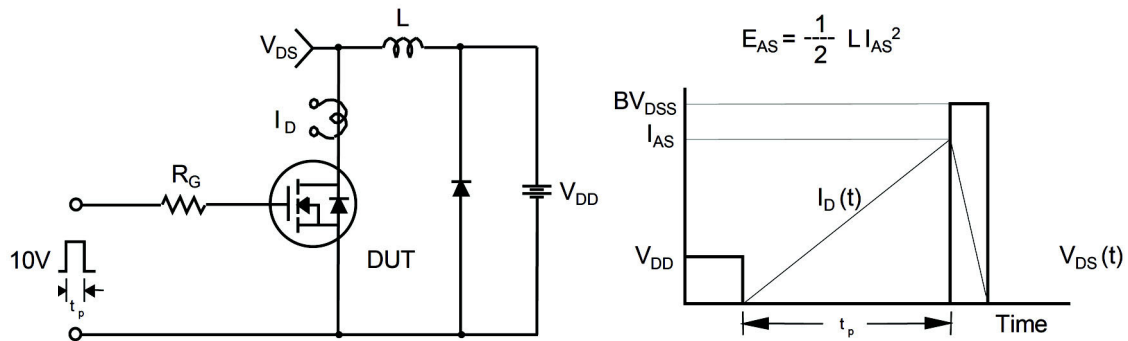

Figure 14. Unclamped Inductive Switching Test Circuit & Waveforms

FDA032N08

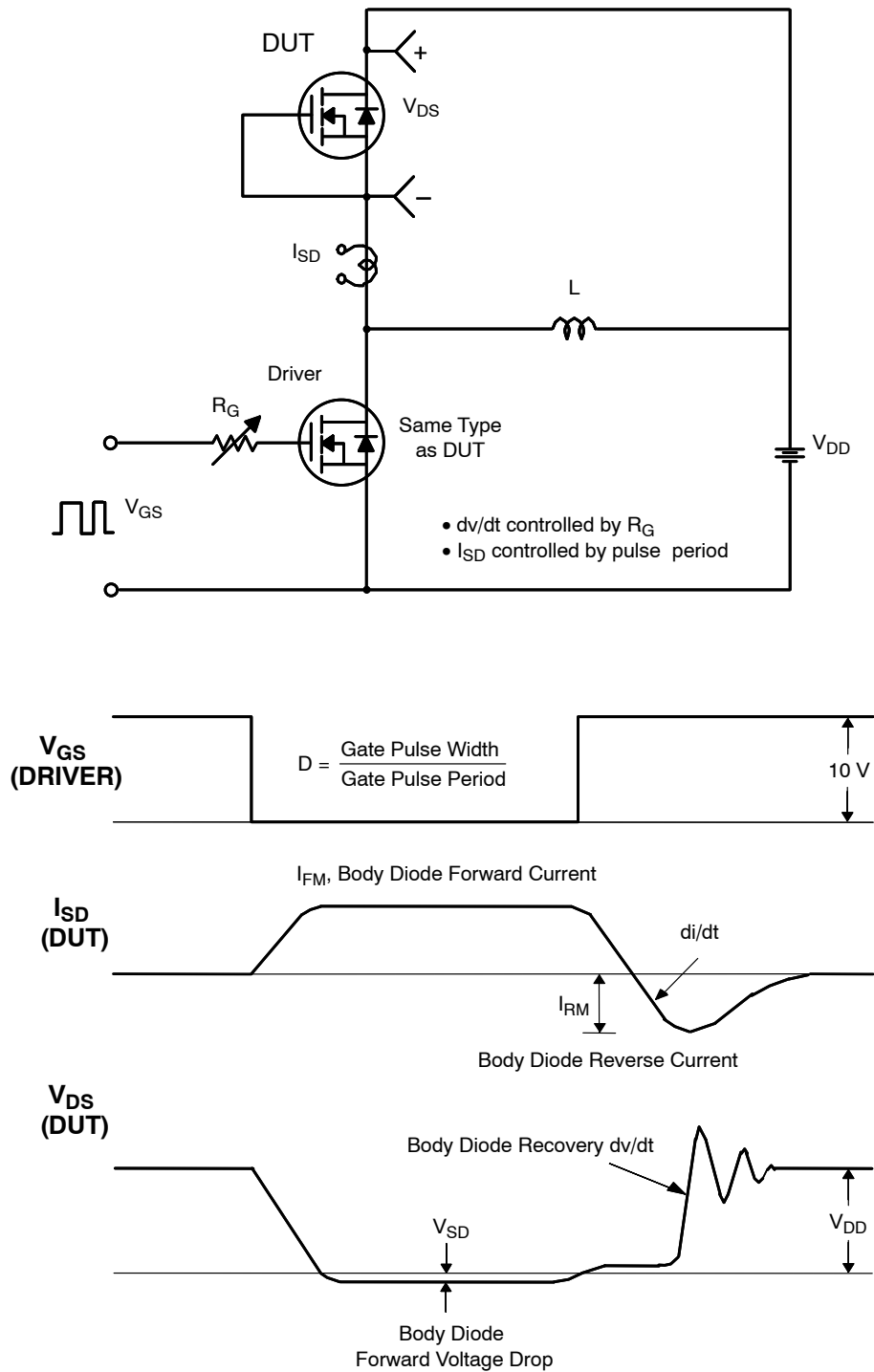

Figure 15. Peak Diode Recovery dv/dt Test Circuit & Waveforms

MECHANICAL CASE OUTLINE

PACKAGE DIMENSIONS

ON Semiconductor®



TO-3P-3LD / EIAJ SC-65, ISOLATED CASE 340BZ ISSUE O

DATE 31 OCT 2016

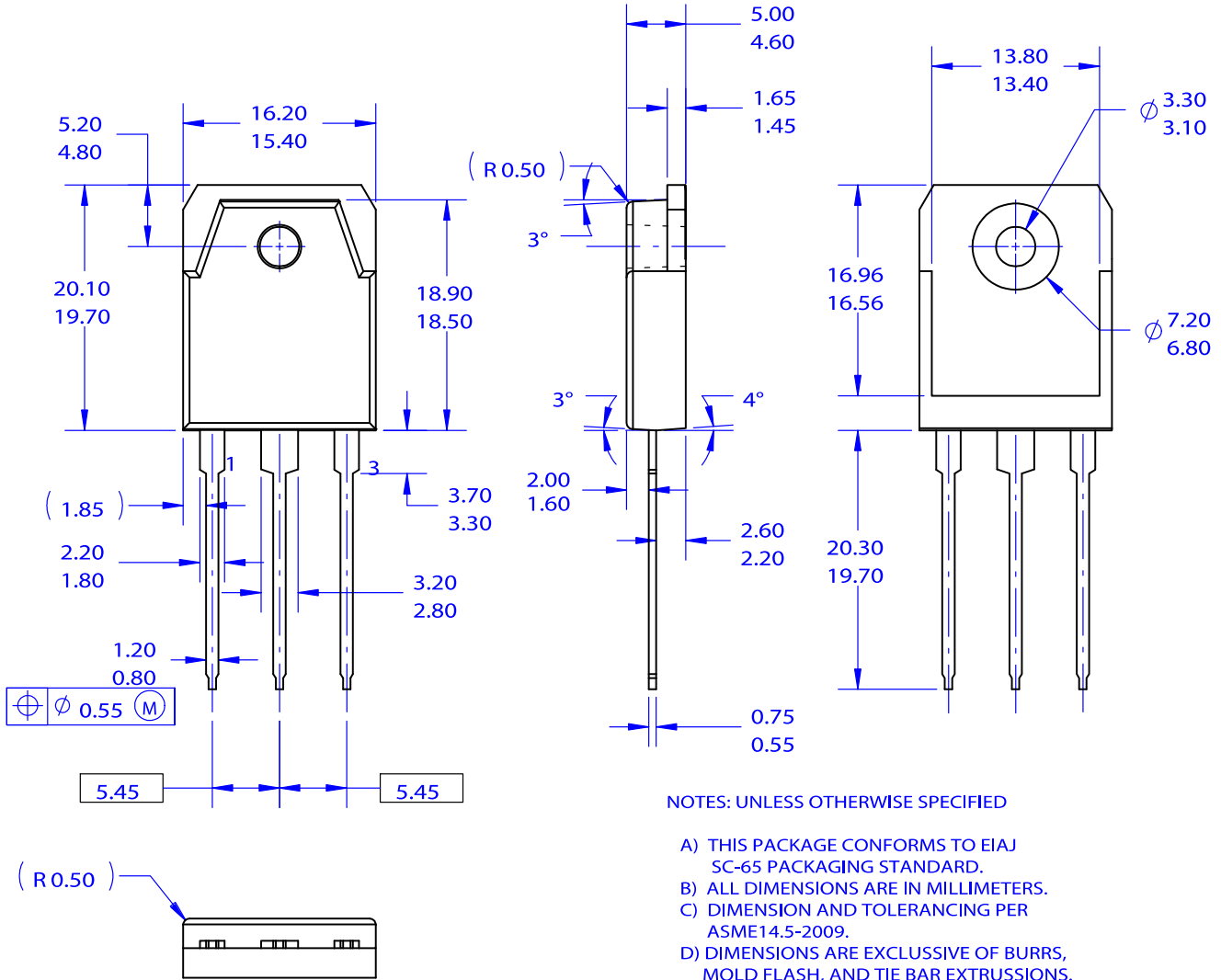

DOCUMENT NUMBER:	98AON13862G	Electronic versions are uncontrolled except when accessed directly from the Document Repository. Printed versions are uncontrolled except when stamped "CONTROLLED COPY" in red.
DESCRIPTION:	TO-3P-3LD / EIAJ SC-65, ISOLATED	PAGE 1 OF 1

ON Semiconductor and are trademarks of Semiconductor Components Industries, LLC dba ON Semiconductor or its subsidiaries in the United States and/or other countries. ON Semiconductor reserves the right to make changes without further notice to any products herein. ON Semiconductor makes no warranty, representation or guarantee regarding the suitability of its products for any particular purpose, nor does ON Semiconductor assume any liability arising out of the application or use of any product or circuit, and specifically disclaims any and all liability, including without limitation special, consequential or incidental damages. ON Semiconductor does not convey any license under its patent rights nor the rights of others.

onsemi, **Onsemi**, and other names, marks, and brands are registered and/or common law trademarks of Semiconductor Components Industries, LLC dba "**onsemi**" or its affiliates and/or subsidiaries in the United States and/or other countries. **onsemi** owns the rights to a number of patents, trademarks, copyrights, trade secrets, and other intellectual property. A listing of **onsemi**'s product/patent coverage may be accessed at www.onsemi.com/site/pdf/Patent-Marking.pdf. **onsemi** reserves the right to make changes at any time to any products or information herein, without notice. The information herein is provided "as-is" and **onsemi** makes no warranty, representation or guarantee regarding the accuracy of the information, product features, availability, functionality, or suitability of its products for any particular purpose, nor does **onsemi** assume any liability arising out of the application or use of any product or circuit, and specifically disclaims any and all liability, including without limitation special, consequential or incidental damages. Buyer is responsible for its products and applications using **onsemi** products, including compliance with all laws, regulations and safety requirements or standards, regardless of any support or applications information provided by **onsemi**. "Typical" parameters which may be provided in **onsemi** data sheets and/or specifications can and do vary in different applications and actual performance may vary over time. All operating parameters, including "Typicals" must be validated for each customer application by customer's technical experts. **onsemi** does not convey any license under any of its intellectual property rights nor the rights of others. **onsemi** products are not designed, intended, or authorized for use as a critical component in life support systems or any FDA Class 3 medical devices or medical devices with a same or similar classification in a foreign jurisdiction or any devices intended for implantation in the human body. Should Buyer purchase or use **onsemi** products for any such unintended or unauthorized application, Buyer shall indemnify and hold **onsemi** and its officers, employees, subsidiaries, affiliates, and distributors harmless against all claims, costs, damages, and expenses, and reasonable attorney fees arising out of, directly or indirectly, any claim of personal injury or death associated with such unintended or unauthorized use, even if such claim alleges that **onsemi** was negligent regarding the design or manufacture of the part. **onsemi** is an Equal Opportunity/Affirmative Action Employer. This literature is subject to all applicable copyright laws and is not for resale in any manner.

ADDITIONAL INFORMATION

TECHNICAL PUBLICATIONS:

Technical Library: www.onsemi.com/design/resources/technical-documentation
onsemi Website: www.onsemi.com

ONLINE SUPPORT: www.onsemi.com/support

For additional information, please contact your local Sales Representative at www.onsemi.com/support/sales