

# C6D20065D1

## 6th Generation 650 V, 20 A Silicon Carbide Schottky Diode

### Description

With the performance advantages of a Silicon Carbide (SiC) Schottky Barrier diode, power electronics systems can expect to meet higher efficiency standards than Si-based solutions, while also reaching higher frequencies and power densities. SiC diodes can be easily paralleled to meet various application demands, without concern of thermal runaway. In combination with the reduced cooling requirements and improved thermal performance of SiC products, SiC diodes are able to provide lower overall system costs in a variety of diverse applications.

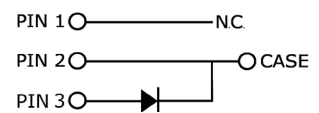
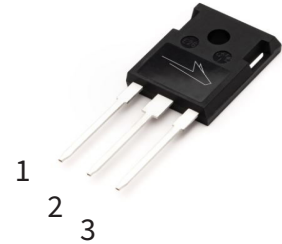

Package Types: TO-247-3  
Marking: C6D20065D1

### Features

- Low Forward Voltage ( $V_F$ ) Drop with Positive Temperature Coefficient
- Zero Reverse Recovery Current / Forward Recovery Voltage
- Temperature-Independent Switching Behavior
- Low Leakage Current ( $I_R$ )

### Applications

- Industrial Power Supplies
- Battery Charging Systems
- Switch Mode Power Supplies
- Solar Inverters
- Server/Telecom Power Supplies

### Maximum Ratings ( $T_c = 25^\circ\text{C}$ Unless Otherwise Specified)

Parameter	Symbol	Value	Unit	Test Conditions	Notes
Repetitive Peak Reverse Voltage	$V_{RRM}$	650	V		
DC Blocking Voltage	$V_{DC}$	650			
Continuous Forward Current	$I_F$	64	A	$T_J = 25^\circ\text{C}$	Fig. 3
		32		$T_J = 125^\circ\text{C}$	
		20		$T_J = 150^\circ\text{C}$	
Repetitive Peak Forward Surge Current	$I_{FRM}$	79	A	$T_c = 25^\circ\text{C}, t_p = 10\text{ ms}, \text{Half Sine Wave}$	
		45		$T_c = 110^\circ\text{C}, t_p = 10\text{ ms}, \text{Half Sine Wave}$	
Non-Repetitive Forward Surge Current	$I_{FSM}$	132	A	$T_c = 25^\circ\text{C}, t_p = 10\text{ ms}, \text{Half Sine Wave}$	Fig. 8
		104		$T_c = 110^\circ\text{C}, t_p = 10\text{ ms}, \text{Half Sine Wave}$	
Non-Repetitive Peak Forward Surge Current	$I_{F,Max}$	1550	A	$T_c = 25^\circ\text{C}, t_p = 10\text{ }\mu\text{s}, \text{Pulse}$	
		1290		$T_c = 110^\circ\text{C}, t_p = 10\text{ }\mu\text{s}, \text{Pulse}$	
Power Dissipation	$P_{tot}$	163	W	$T_J = 25^\circ\text{C}$	Fig. 4
		71		$T_J = 110^\circ\text{C}$	
$i^2t$ value	$\int i^2 dt$	87	$\text{A}^2\text{s}$	$T_c = 25\text{C}, t_p=10\text{ms}$	
		54		$T_c = 110\text{C}, t_p=10\text{ms}$	

## Electrical Characteristics

Parameter	Symbol	Typ.	Max.	Unit	Test Conditions	Notes
Forward Voltage	$V_F$	1.27	1.50	V	$I_F = 20 \text{ A}, T_j = 25 \text{ }^\circ\text{C}$	Fig. 1
		1.37	1.60		$I_F = 20 \text{ A}, T_j = 175 \text{ }^\circ\text{C}$	
Reverse Current	$I_R$	5	30	$\mu\text{A}$	$V_R = 650 \text{ V}, T_j = 25 \text{ }^\circ\text{C}$	Fig. 2
		40	300		$V_R = 650 \text{ V}, T_j = 175 \text{ }^\circ\text{C}$	
Total Capacitive Charge	$Q_C$	63		nC	$V_R = 400 \text{ V}, T_j = 25 \text{ }^\circ\text{C}$	Fig. 5
Total Capacitance	C	1153		pF	$V_R = 0 \text{ V}, T_j = 25 \text{ }^\circ\text{C}, f = 1 \text{ MHz}$	Fig. 6
		120			$V_R = 200 \text{ V}, T_j = 25 \text{ }^\circ\text{C}, f = 1 \text{ MHz}$	
		97			$V_R = 400 \text{ V}, T_j = 25 \text{ }^\circ\text{C}, f = 1 \text{ MHz}$	
Capacitance Stored Energy	$E_C$	9.5		$\mu\text{J}$	$V_R = 400 \text{ V}$	Fig. 7

### Notes:

SiC Schottky Diodes are majority carrier devices, so there is no reverse recovery charge.

## Thermal & Mechanical Characteristics

Parameter	Symbol	Value	Unit	Notes
Thermal Resistance, Junction to Case (Typical)	$R_{\theta, JC (TYP)}$	0.76	$^\circ\text{C} / \text{W}$	
Junction Temperature	$T_j$	-55 to +175	$^\circ\text{C}$	
Case & Storage Temperature	$T_c$	-55 to +175		
TO-247 Mounting Torque	-	1	Nm	M3 Screw
		8.8	lbf-in	6-32 Screw

## Electrostatic Discharge (ESD) Classifications

Parameter	Symbol	Notes
Human Body Model	HBM	Class 3B ( $\geq 8000 \text{ V}$ )
Charge Device Model	CDM	Class C3 ( $\geq 1000 \text{ V}$ )

Typical Performance

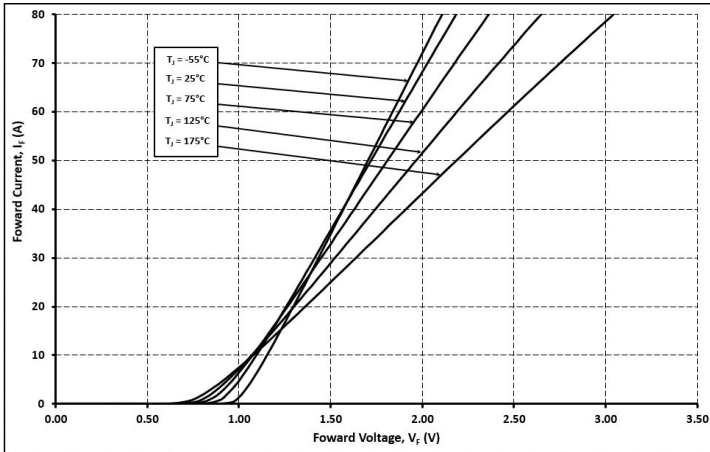

Figure 1  
Forward Characteristics

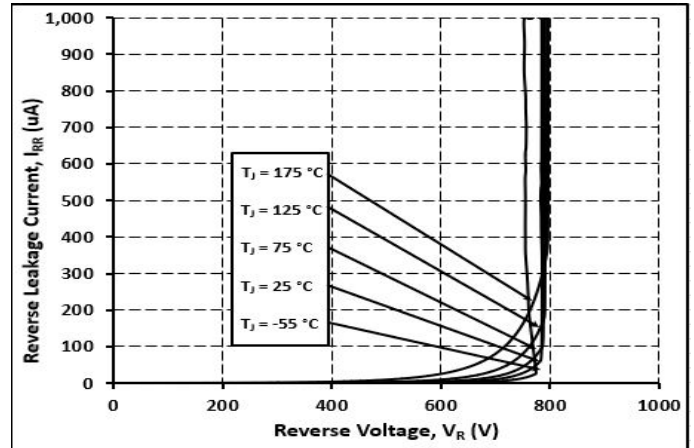

Figure 2  
Reverse Characteristics

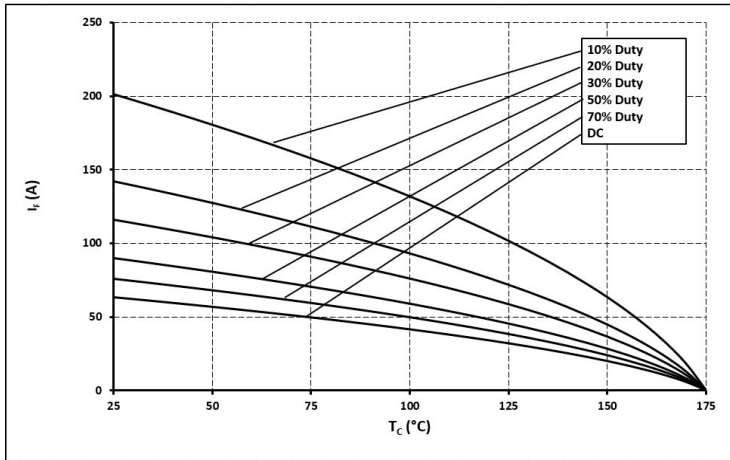

Figure 3  
Current Derating

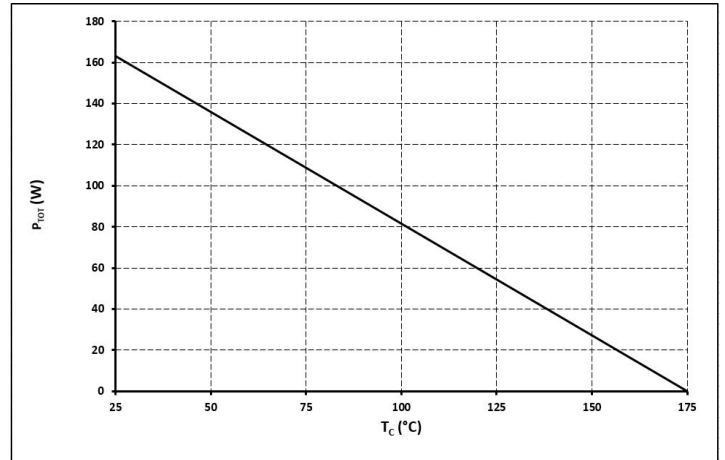

Figure 4  
Power Derating

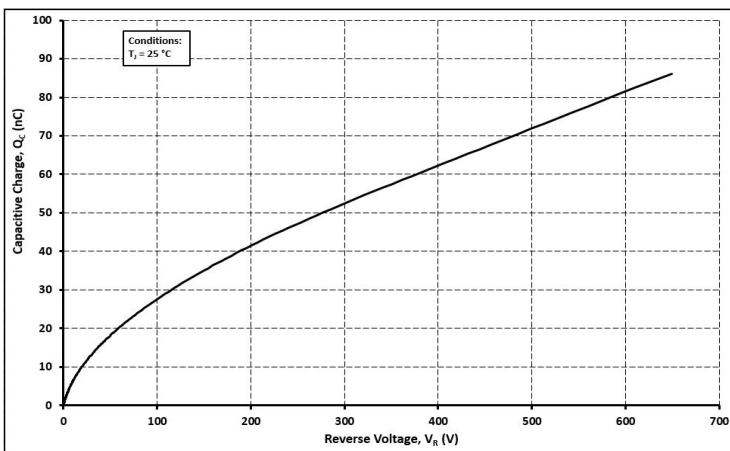

Figure 5  
Total Capacitance Charge vs. Reverse Voltage

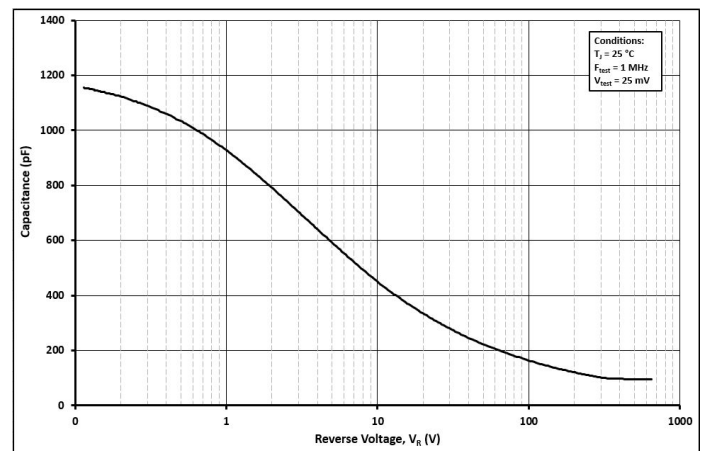
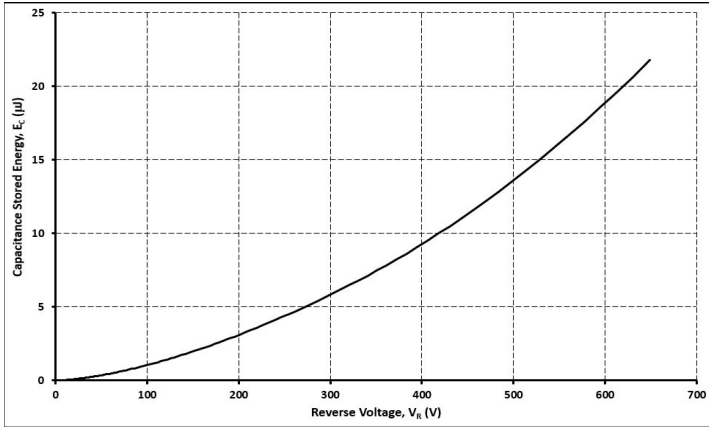

Figure 6  
Capacitance vs. Reverse Voltage



**Typical Performance**



**Figure 7**

Capacitance Stored Energy

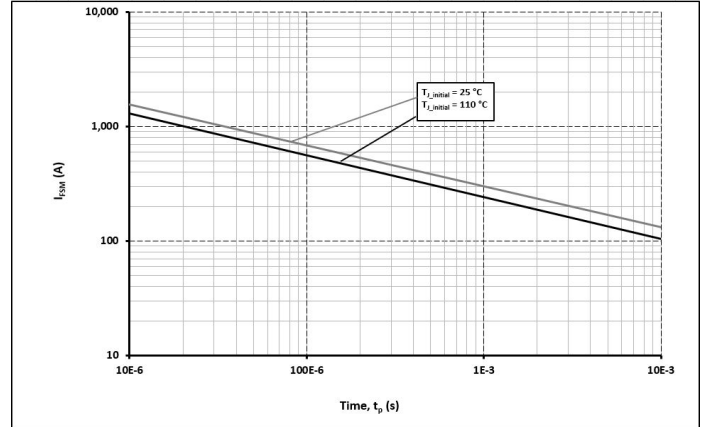

**Figure 8**

Non-Repetitive Peak Forward Surge Current vs. Pulse Duration

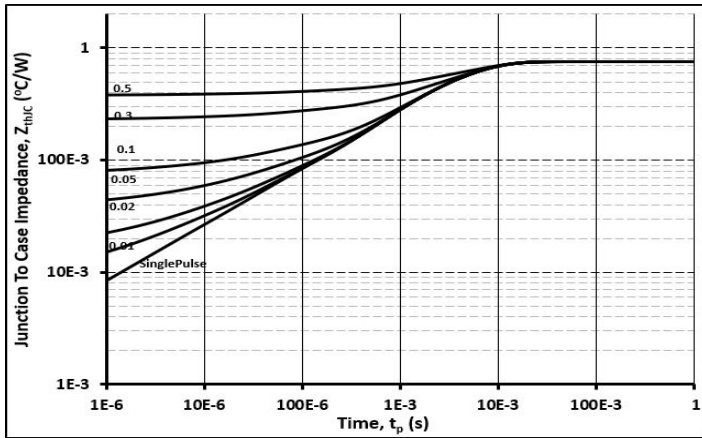
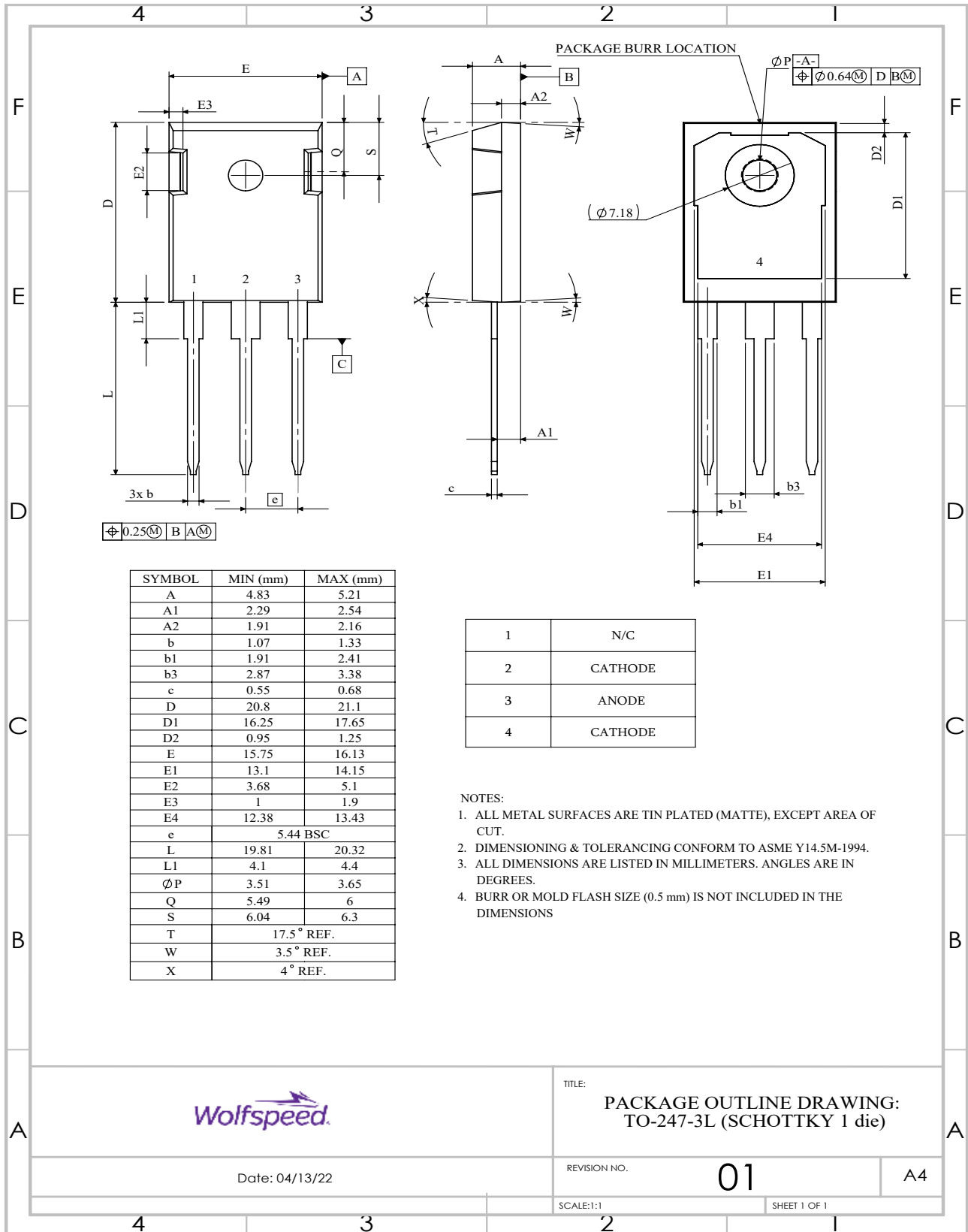

**Figure 9**

Transient Thermal Impedance

### Package Dimensions & Pin-Out

Package: TO-247-3



TITLE: PACKAGE OUTLINE DRAWING:  
TO-247-3L (SCHOTTKY 1 die)

Date: 04/13/22

REVISION NO.

01

A4

SCALE:1:1

SHEET 1 OF 1

### Recommended Solder Pad Layout

Primary dimensions shown in mm.

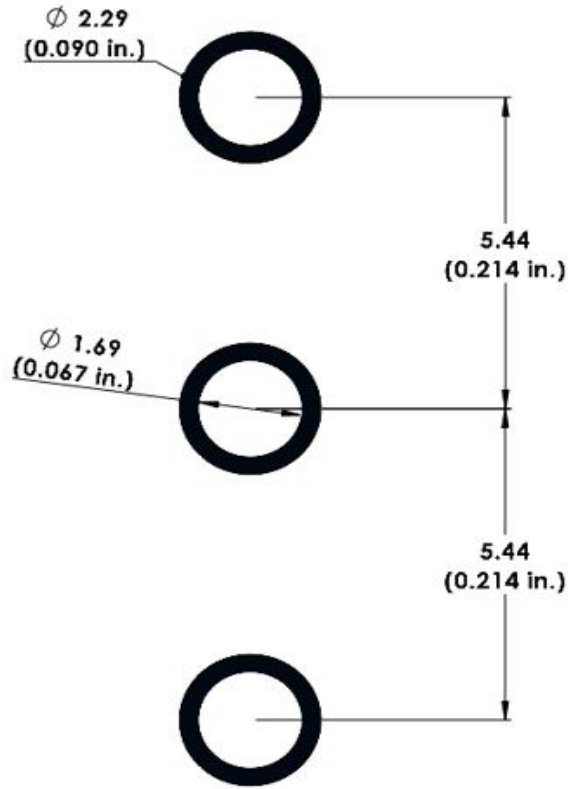

### Product Ordering Information

Order Number	Packing Type
C6D20065D1	Tube

REACH, RoHS, and Halogen-Free compliance documentation available for this product.



## Revision History

Document Version	Date of Release	Description of Changes
0	April-2023	Initial Release

## Notes & Disclaimer

---

This document and the information contained herein are subject to change without notice. Any such change shall be evidenced by the publication of an updated version of this document by Wolfspeed. No communication from any employee or agent of Wolfspeed or any third party shall effect an amendment or modification of this document. No responsibility is assumed by Wolfspeed for any infringement of patents or other rights of third parties which may result from use of the information contained herein. No license is granted by implication or otherwise under any patent or patent rights of Wolfspeed.

Notwithstanding any application-specific information, guidance, assistance, or support that Wolfspeed may provide, the buyer of this product is solely responsible for determining the suitability of this product for the buyer's purposes, including without limitation for use in the applications identified in the next bullet point, and for the compliance of the buyers' products, including those that incorporate this product, with all applicable legal, regulatory, and safety-related requirements.

This product has not been designed or tested for use in, and is not intended for use in, applications in which failure of the product would reasonably be expected to cause death, personal injury, or property damage, including but not limited to equipment implanted into the human body, life-support machines, cardiac defibrillators, and similar emergency medical equipment, aircraft navigation, communication, and control systems, aircraft power and propulsion systems, air traffic control systems, and equipment used in the planning, construction, maintenance, or operation of nuclear facilities.

### **RoHS Compliance**

The levels of RoHS restricted materials in this product are below the maximum concentration values (also referred to as the threshold limits) permitted for such substances, or are used in an exempted application, in accordance with EU Directive 2011/65/EC (RoHS2), as implemented January 2, 2013. RoHS Declarations for this product can be obtained from your Wolfspeed representative or from the Product Documentation sections of [www.wolfspeed.com](http://www.wolfspeed.com).

### **REACH Compliance**

REACH substances of high concern (SVHCs) information is available for this product. Since the European Chemical Agency (ECHA) has published notice of their intent to frequently revise the SVHC listing for the foreseeable future, please contact your Wolfspeed representative to ensure you get the most up-to-date REACH SVHC Declaration. REACH banned substance information (REACH Article 67) is also available upon request.

### **Contact info:**

4600 Silicon Drive  
Durham, NC 27703 USA  
Tel: +1.919.313.5300  
[www.wolfspeed.com/power](http://www.wolfspeed.com/power)