

High Voltage Schottky Rectifier

High Barrier Technology for Improved High Temperature Performance

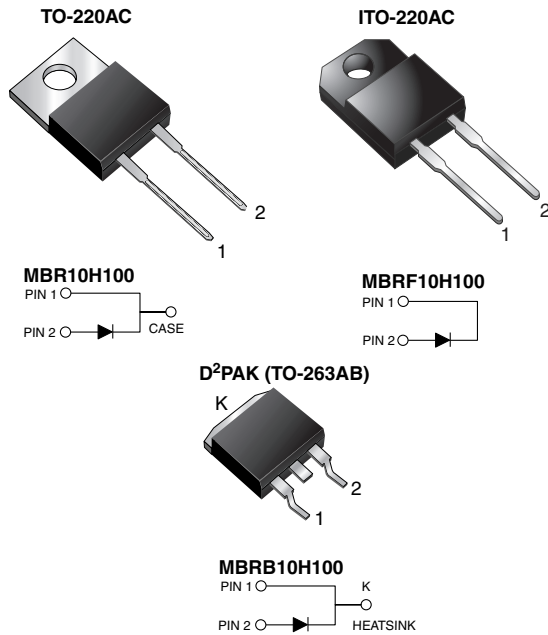

RoHS
COMPLIANT
HALOGEN
FREE
Available

FEATURES

- Power pack
- Guardring for overvoltage protection
- Low power loss, high efficiency
- Low forward voltage drop
- Low leakage current
- High forward surge capability
- High frequency operation
- Meets MSL level 1, per J-STD-020, LF maximum peak of 245 °C (for TO-263AB package)
- Solder bath temperature 275 °C maximum, 10 s, per JESD 22-B106 (for TO-220AC and ITO-220AC package)
- Material categorization: for definitions of compliance please see www.vishay.com/doc?99912

TYPICAL APPLICATIONS

For use in high frequency rectifier of switching mode power supplies, freewheeling diodes, DC/DC converters, or polarity protection application.

MECHANICAL DATA

Case: TO-220AC, ITO-220AC, D²PAK (TO-263AB)

Molding compound meets UL 94 V-0 flammability rating

Base P/N-E3 - RoHS-compliant, commercial grade

Base P/N-M3 - RoHS-compliant, halogen-free, commercial grade

Terminals: matte tin plated leads, solderable per J-STD-002 and JESD 22-B102

E3 and M3 suffix meets JESD 201 class 1A whisker test

Polarity: as marked

Mounting Torque: 10 in-lbs maximum

LINKS TO ADDITIONAL RESOURCES



PRIMARY CHARACTERISTICS	
$I_{F(AV)}$	10 A
V_{RRM}	100 V
I_{FSM}	250 A
V_F	0.64 V
I_R	4.5 μ A
T_J max.	175 °C
Package	TO-220AC, ITO-220AC, D ² PAK (TO-263AB)
Circuit configurations	Single

MAXIMUM RATINGS ($T_C = 25$ °C unless otherwise noted)			
PARAMETER	SYMBOL	MBR10H100 MBRB10H100 MBRF10H100	UNIT
Maximum repetitive peak reverse voltage	V_{RRM}	100	V
Working peak reverse voltage	V_{RWM}	100	
Maximum DC blocking voltage	V_{DC}	100	
Maximum average forward rectified current	$I_{F(AV)}$	10	A
Peak forward surge current 8.3 ms single half sine-wave superimposed on rated load	I_{FSM}	250	
Peak repetitive reverse current at $t_p = 2.0$ μ s, 1 kHz	I_{RRM}	0.5	
Voltage rate of change (rated V_R)	dV/dt	10 000	V/ μ s
Operating junction and storage temperature range	T_J, T_{STG}	-65 to +175	°C
Isolation voltage (ITO-220AC only) from terminal to heatsink $t = 1$ min	V_{AC}	1500	V



ELECTRICAL CHARACTERISTICS ($T_C = 25\text{ }^\circ\text{C}$ unless otherwise noted)					
PARAMETER	SYMBOL	TEST CONDITIONS		VALUE	UNIT
Maximum instantaneous forward voltage	$V_F^{(1)}$	$I_F = 10\text{ A}$	$T_C = 25\text{ }^\circ\text{C}$	0.77	V
		$I_F = 10\text{ A}$	$T_C = 125\text{ }^\circ\text{C}$	0.64	
		$I_F = 20\text{ A}$	$T_C = 25\text{ }^\circ\text{C}$	0.88	
		$I_F = 20\text{ A}$	$T_C = 125\text{ }^\circ\text{C}$	0.73	
Maximum reverse current	$I_R^{(2)}$	Rated V_R	$T_J = 25\text{ }^\circ\text{C}$	4.5	μA
			$T_J = 125\text{ }^\circ\text{C}$	6.0	mA

Notes

(1) Pulse test: 300 μs pulse width, 1 % duty cycle

(2) Pulse test: Pulse width $\leq 40\text{ ms}$

THERMAL CHARACTERISTICS ($T_C = 25\text{ }^\circ\text{C}$ unless otherwise noted)					
PARAMETER	SYMBOL	MBR10H100	MBRF10H100	MBRB10H100	UNIT
Typical thermal resistance	$R_{\theta JC}$	2.7	5.8	2.7	$^\circ\text{C/W}$

ORDERING INFORMATION					
PACKAGE	PREFERRED P/N	UNIT WEIGHT (g)	PACKAGE CODE	BASE QUANTITY	DELIVERY MODE
TO-220AC	MBR10H100-E3/45	1.80	45	50/tube	Tube
ITO-220AC	MBRF10H100-E3/45	1.94	45	50/tube	Tube
D ² PAK (TO-263AB)	MBRB10H100-M3/I	1.33	I	800/reel	Tape and reel



RATINGS AND CHARACTERISTICS CURVES ($T_C = 25\text{ }^\circ\text{C}$ unless otherwise noted)

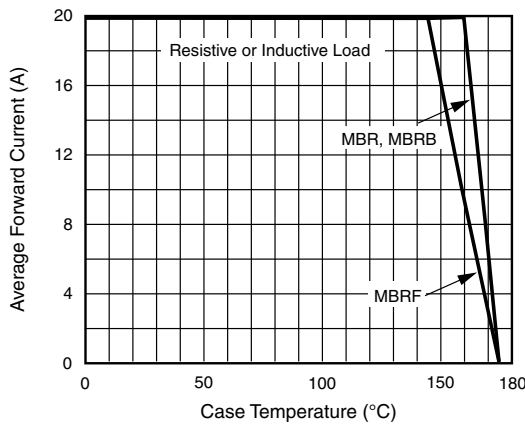

Fig. 1 - Forward Current Derating Curve

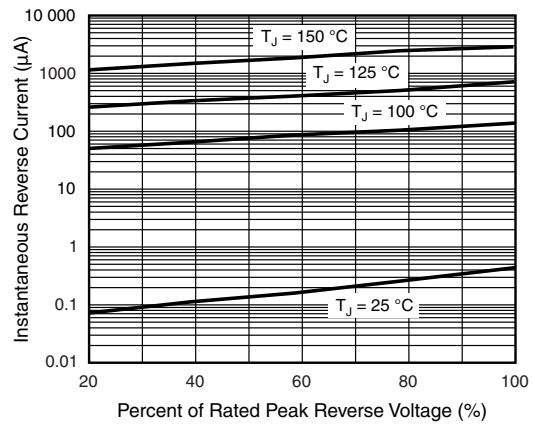

Fig. 4 - Typical Reverse Characteristics

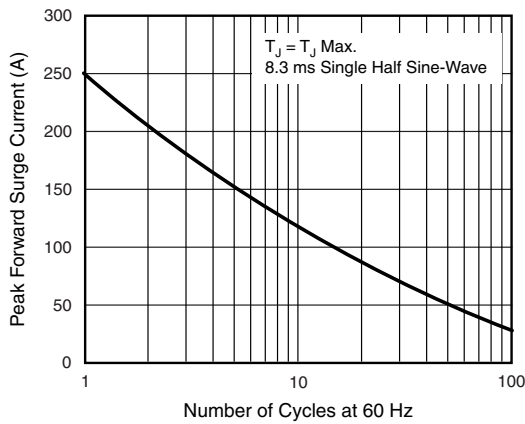

Fig. 2 - Maximum Non-Repetitive Peak Forward Surge Current

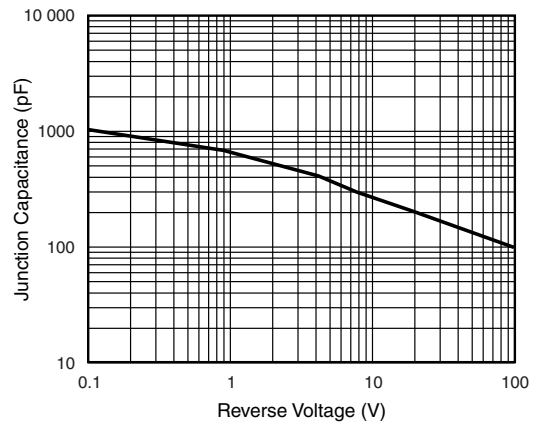

Fig. 5 - Typical Junction Capacitance

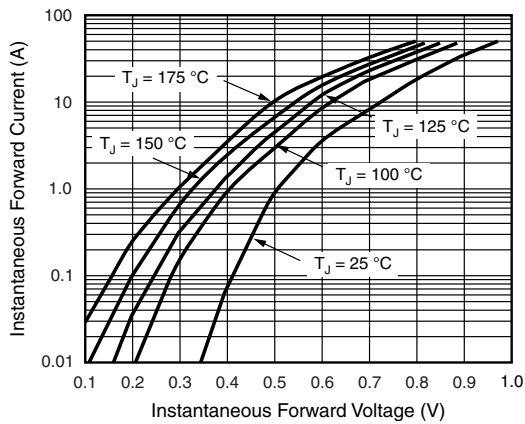

Fig. 3 - Typical Instantaneous Forward Characteristics

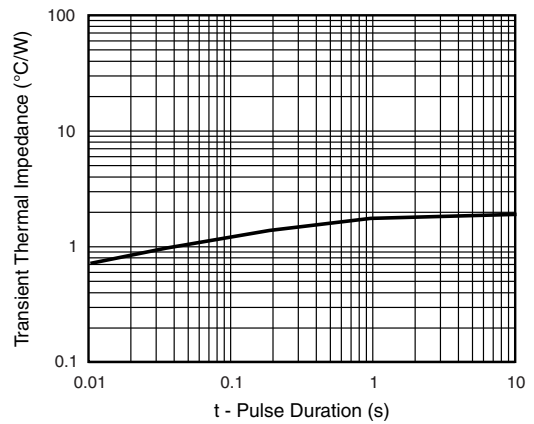
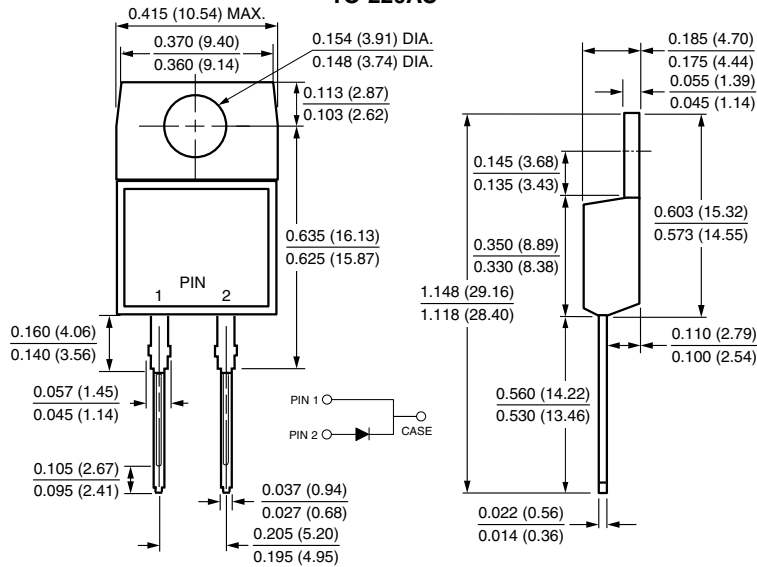

Fig. 6 - Typical Transient Thermal Impedance



PACKAGE OUTLINE DIMENSIONS in inches (millimeters)

TO-220AC



ITO-220AC

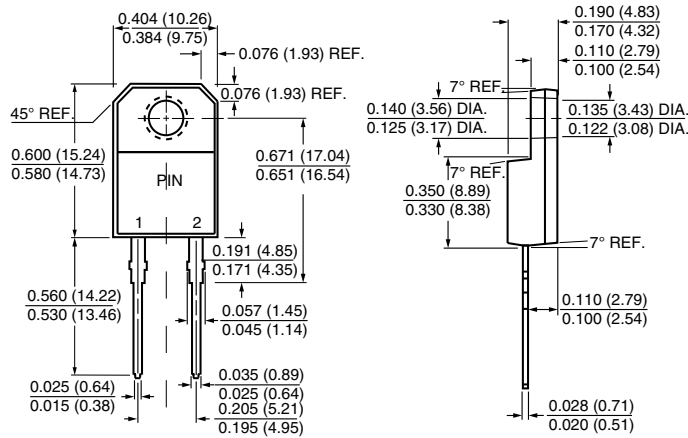

D²PAK (TO-263AB)

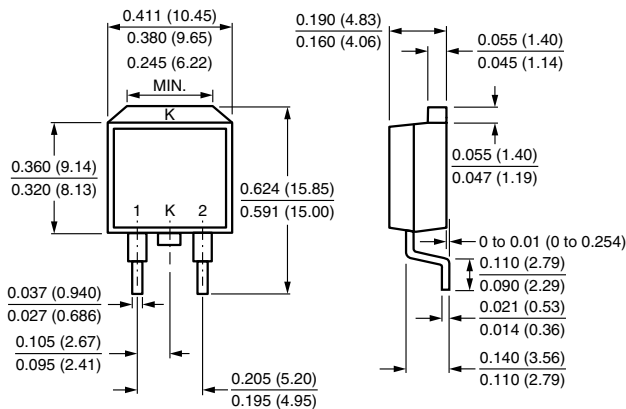

Mounting Pad Layout

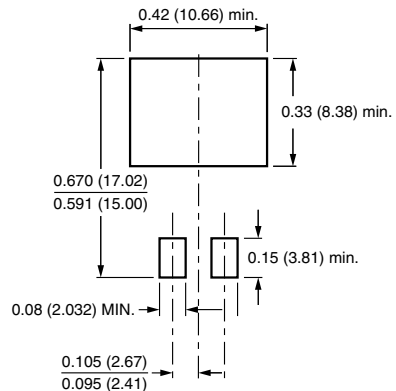



Disclaimer

ALL PRODUCT, PRODUCT SPECIFICATIONS AND DATA ARE SUBJECT TO CHANGE WITHOUT NOTICE TO IMPROVE RELIABILITY, FUNCTION OR DESIGN OR OTHERWISE.

Vishay Intertechnology, Inc., its affiliates, agents, and employees, and all persons acting on its or their behalf (collectively, "Vishay"), disclaim any and all liability for any errors, inaccuracies or incompleteness contained in any datasheet or in any other disclosure relating to any product.

Vishay makes no warranty, representation or guarantee regarding the suitability of the products for any particular purpose or the continuing production of any product. To the maximum extent permitted by applicable law, Vishay disclaims (i) any and all liability arising out of the application or use of any product, (ii) any and all liability, including without limitation special, consequential or incidental damages, and (iii) any and all implied warranties, including warranties of fitness for particular purpose, non-infringement and merchantability.

Statements regarding the suitability of products for certain types of applications are based on Vishay's knowledge of typical requirements that are often placed on Vishay products in generic applications. Such statements are not binding statements about the suitability of products for a particular application. It is the customer's responsibility to validate that a particular product with the properties described in the product specification is suitable for use in a particular application. Parameters provided in datasheets and / or specifications may vary in different applications and performance may vary over time. All operating parameters, including typical parameters, must be validated for each customer application by the customer's technical experts. Product specifications do not expand or otherwise modify Vishay's terms and conditions of purchase, including but not limited to the warranty expressed therein.

Hyperlinks included in this datasheet may direct users to third-party websites. These links are provided as a convenience and for informational purposes only. Inclusion of these hyperlinks does not constitute an endorsement or an approval by Vishay of any of the products, services or opinions of the corporation, organization or individual associated with the third-party website. Vishay disclaims any and all liability and bears no responsibility for the accuracy, legality or content of the third-party website or for that of subsequent links.

Except as expressly indicated in writing, Vishay products are not designed for use in medical, life-saving, or life-sustaining applications or for any other application in which the failure of the Vishay product could result in personal injury or death. Customers using or selling Vishay products not expressly indicated for use in such applications do so at their own risk. Please contact authorized Vishay personnel to obtain written terms and conditions regarding products designed for such applications.

No license, express or implied, by estoppel or otherwise, to any intellectual property rights is granted by this document or by any conduct of Vishay. Product names and markings noted herein may be trademarks of their respective owners.