

# MPS6717

## One Watt Amplifier Transistor

### NPN Silicon

#### Features

- Pb-Free Packages are Available\*

#### MAXIMUM RATINGS

Rating	Symbol	Value	Unit
Collector-Emitter Voltage	$V_{CEO}$	80	Vdc
Collector-Base Voltage	$V_{CBO}$	80	Vdc
Emitter-Base Voltage	$V_{EBO}$	5.0	Vdc
Collector Current - Continuous	$I_C$	500	mAdc
Total Device Dissipation @ $T_A = 25^\circ\text{C}$ Derate above $25^\circ\text{C}$	$P_D$	1.0 8.0	W mW/ $^\circ\text{C}$
Total Device Dissipation @ $T_C = 25^\circ\text{C}$ Derate above $25^\circ\text{C}$	$P_D$	2.5 20	W mW/ $^\circ\text{C}$
Operating and Storage Junction Temperature Range	$T_J, T_{stg}$	-55 to +150	$^\circ\text{C}$

#### THERMAL CHARACTERISTICS

Characteristic	Symbol	Max	Unit
Thermal Resistance, Junction-to-Ambient	$R_{\theta JA}$	125	$^\circ\text{C}/\text{W}$
Thermal Resistance, Junction-to-Case	$R_{\theta JC}$	50	$^\circ\text{C}/\text{W}$

Maximum ratings are those values beyond which device damage can occur. Maximum ratings applied to the device are individual stress limit values (not normal operating conditions) and are not valid simultaneously. If these limits are exceeded, device functional operation is not implied, damage may occur and reliability may be affected.

\*For additional information on our Pb-Free strategy and soldering details, please download the ON Semiconductor Soldering and Mounting Techniques Reference Manual, SOLDERRM/D.



ON Semiconductor®

<http://onsemi.com>

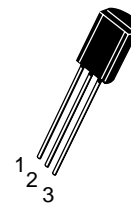
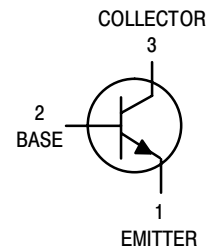

TO-92 (TO-226)  
CASE 29-10  
STYLE 1

#### MARKING DIAGRAM

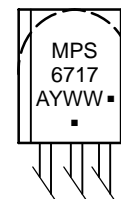

MPS6717 = Device Code  
A = Assembly Location  
Y = Year  
WW = Work Week  
▪ = Pb-Free Package  
(Note: Microdot may be in either location)

#### ORDERING INFORMATION

Device	Package	Shipping†
MPS6717	TO-92	5000 Units / Bulk
MPS6717G	TO-92 (Pb-Free)	5000 Units / Bulk
MPS6717RLRA	TO-92	2000/Tape & Reel
MPS6717RLRAG	TO-92 (Pb-Free)	2000/Tape & Reel

†For information on tape and reel specifications, including part orientation and tape sizes, please refer to our Tape and Reel Packaging Specifications Brochure, BRD8011/D.

# MPS6717

## ELECTRICAL CHARACTERISTICS (T<sub>A</sub> = 25°C unless otherwise noted)

Characteristic	Symbol	Min	Max	Unit
<b>OFF CHARACTERISTICS</b>				
Collector–Emitter Breakdown Voltage (Note 1) (I <sub>C</sub> = 1.0 mA, I <sub>B</sub> = 0)	V <sub>(BR)CEO</sub>	80	–	Vdc
Collector–Base Breakdown Voltage (I <sub>C</sub> = 100 μA, I <sub>E</sub> = 0)	V <sub>(BR)CBO</sub>	80	–	Vdc
Emitter–Base Breakdown Voltage (I <sub>E</sub> = 10 μA, I <sub>C</sub> = 0)	V <sub>(BR)EBO</sub>	5.0	–	Vdc
Collector Cutoff Current (V <sub>CB</sub> = 60 Vdc, I <sub>E</sub> = 0)	I <sub>CBO</sub>	–	0.1	μA
Emitter Cutoff Current (V <sub>EB</sub> = 5.0 Vdc, I <sub>C</sub> = 0)	I <sub>EBO</sub>	–	10	μA

## ON CHARACTERISTICS

DC Current Gain (I <sub>C</sub> = 50 mA, V <sub>CE</sub> = 1.0 Vdc) (I <sub>C</sub> = 250 mA, V <sub>CE</sub> = 1.0 Vdc)	h <sub>FE</sub>	80 50	– 250	–
Collector–Emitter Saturation Voltage (I <sub>C</sub> = 250 mA, I <sub>B</sub> = 10 mA)	V <sub>CE(sat)</sub>	–	0.5	Vdc
Base–Emitter On Voltage (I <sub>C</sub> = 250 mA, V <sub>CE</sub> = 1.0 Vdc)	V <sub>BE(on)</sub>	–	1.2	Vdc

## SMALL-SIGNAL CHARACTERISTICS

Collector–Base Capacitance (V <sub>CB</sub> = 10 Vdc, I <sub>E</sub> = 0, f = 1.0 MHz)	C <sub>cb</sub>	–	30	pF
Small–Signal Current Gain (I <sub>C</sub> = 200 mA, V <sub>CE</sub> = 5.0 Vdc, f = 20 MHz)	h <sub>fe</sub>	2.5	25	–

1. Pulse Test: Pulse Width ≤ 300 μs; Duty Cycle ≤ 2.0%.

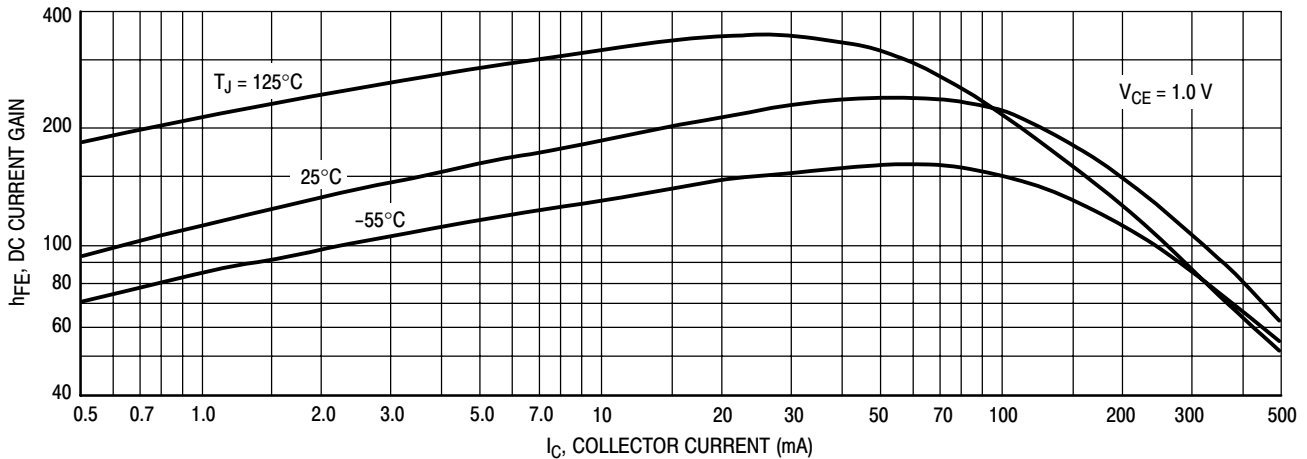

Figure 1. DC Current Gain

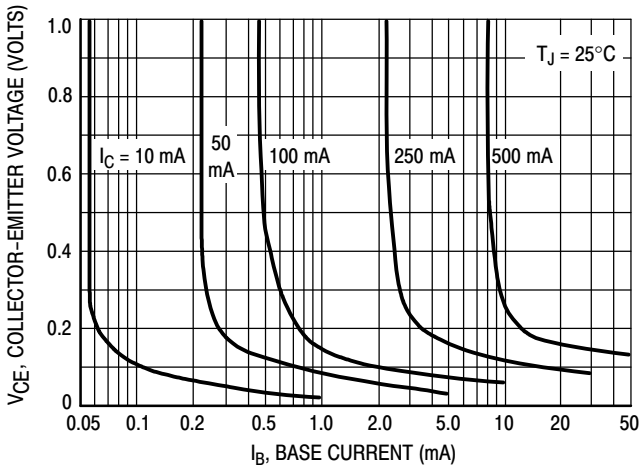

Figure 2. Collector Saturation Region

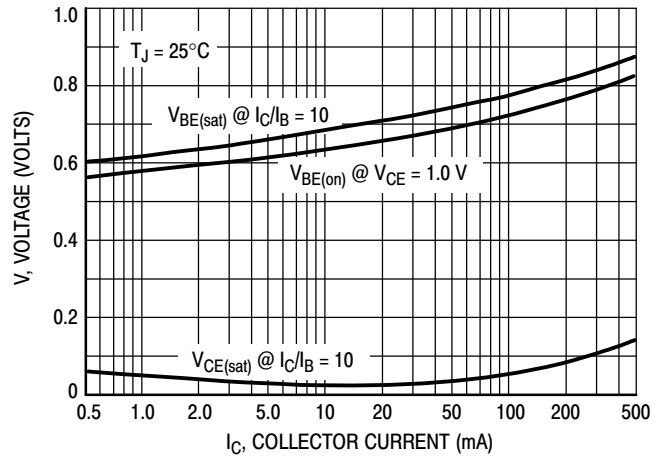

Figure 3. "On" Voltages

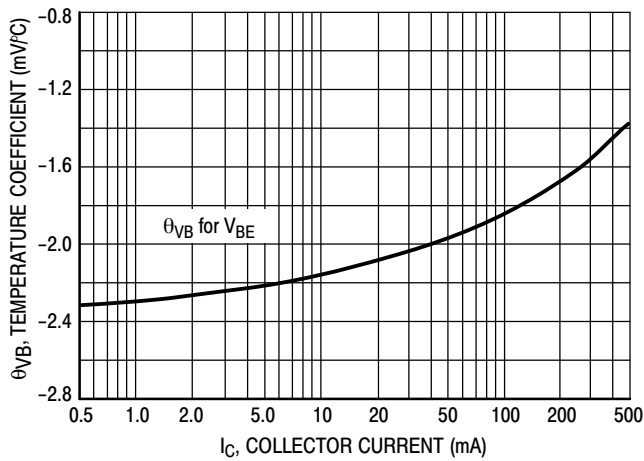

Figure 4. Base-Emitter Temperature Coefficient

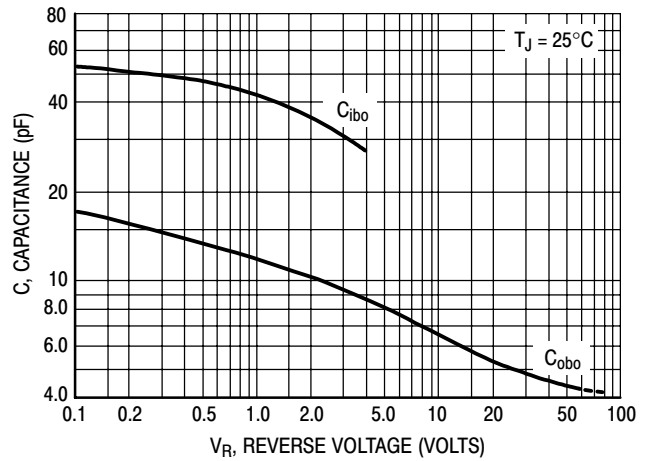

Figure 5. Capacitance

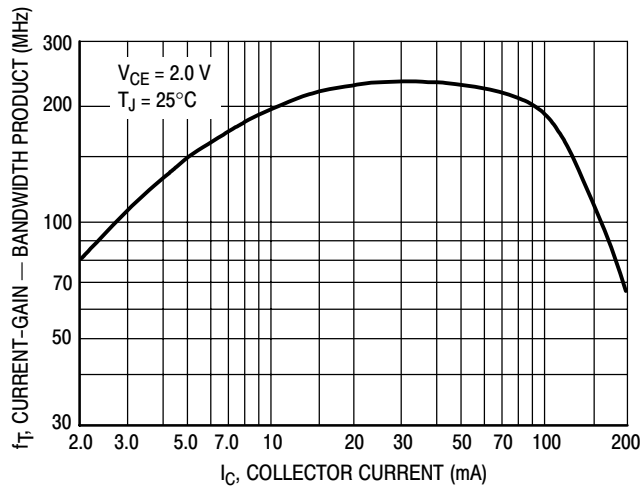

Figure 6. Current-Gain — Bandwidth Product

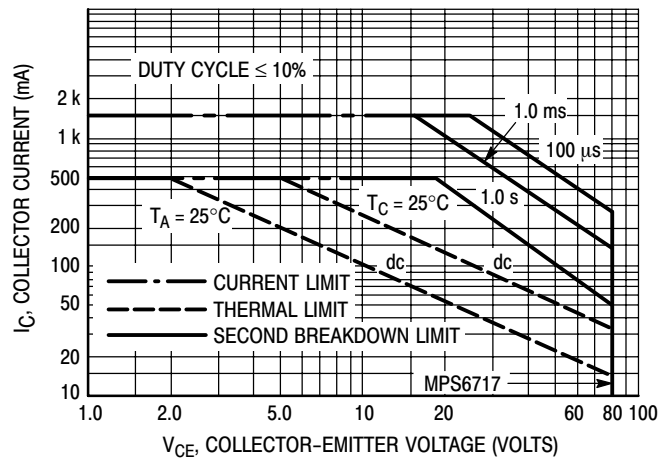

Figure 7. Active Region — Safe Operating Area

# MECHANICAL CASE OUTLINE

## PACKAGE DIMENSIONS

ON Semiconductor®



SCALE 1:1

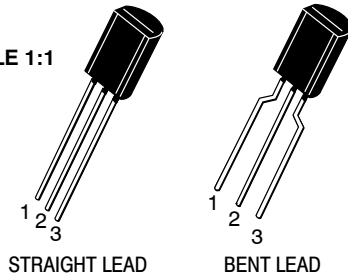

TO-92 (TO-226) 1 WATT  
CASE 29-10  
ISSUE D

DATE 05 MAR 2021

### STRAIGHT LEAD

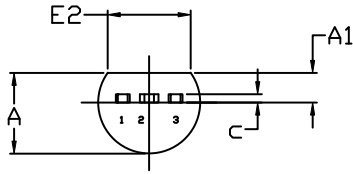

END VIEW

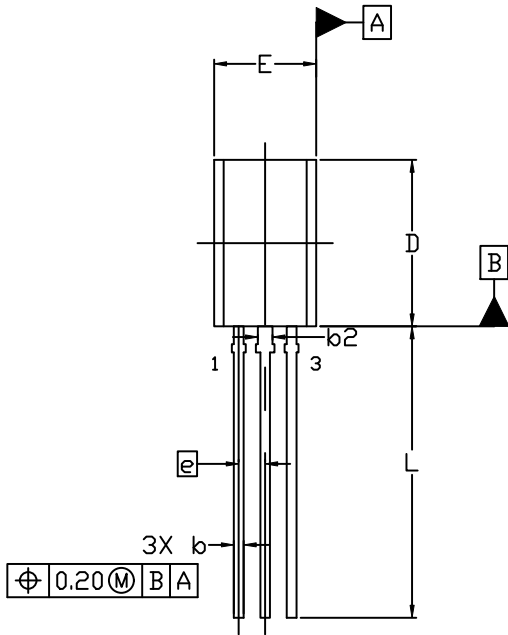

TOP VIEW

#### NOTES:

1. DIMENSIONING AND TOLERANCING PER ASME Y14.5M, 2009.
2. CONTROLLING DIMENSION: MILLIMETERS
3. DIMENSIONS D AND E DO NOT INCLUDE MOLD FLASH OR GATE PROTRUSIONS.
4. DIMENSION b AND b2 DOES NOT INCLUDE DAMBAR PROTRUSION. LEAD WIDTH INCLUDING PROTRUSION SHALL NOT EXCEED 0.20. DIMENSION b2 LOCATED ABOVE THE DAMBAR PORTION OF MIDDLE LEAD.

DIM	MILLIMETERS		
	MIN.	NOM.	MAX.
A	3.75	3.90	4.05
A1	1.28	1.43	1.58
b	0.38	0.465	0.55
b2	0.62	0.70	0.78
c	0.35	0.40	0.45
D	7.85	8.00	8.15
E	4.75	4.90	5.05
E2	3.90	---	---
e	1.27 BSC		
L	13.80	14.00	14.20

### STYLES AND MARKING ON PAGE 3

DOCUMENT NUMBER:	98AON52857E	Electronic versions are uncontrolled except when accessed directly from the Document Repository. Printed versions are uncontrolled except when stamped "CONTROLLED COPY" in red.
DESCRIPTION:	TO-92 (TO-226) 1 WATT	PAGE 1 OF 3

ON Semiconductor and are trademarks of Semiconductor Components Industries, LLC dba ON Semiconductor or its subsidiaries in the United States and/or other countries. ON Semiconductor reserves the right to make changes without further notice to any products herein. ON Semiconductor makes no warranty, representation or guarantee regarding the suitability of its products for any particular purpose, nor does ON Semiconductor assume any liability arising out of the application or use of any product or circuit, and specifically disclaims any and all liability, including without limitation special, consequential or incidental damages. ON Semiconductor does not convey any license under its patent rights nor the rights of others.

**TO-92 (TO-226) 1 WATT**  
**CASE 29-10**  
**ISSUE D**

DATE 05 MAR 2021

FORMED LEAD



END VIEW

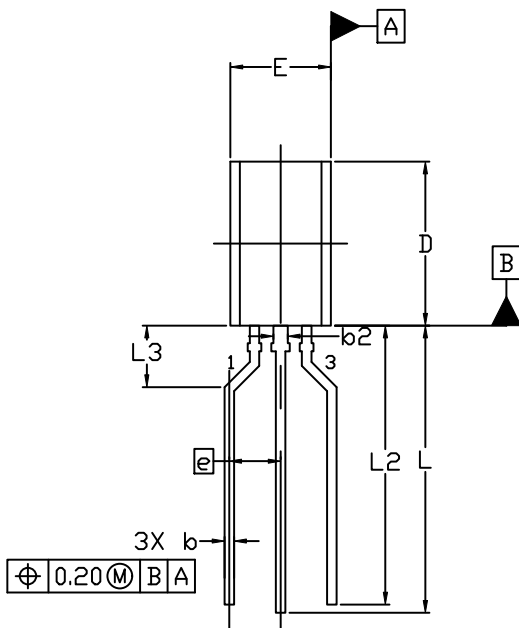

TOP VIEW

NOTES:

1. DIMENSIONING AND TOLERANCING PER ASME Y14.5M, 2009.
2. CONTROLLING DIMENSION: MILLIMETERS
3. DIMENSIONS D AND E DO NOT INCLUDE MOLD FLASH OR GATE PROTRUSIONS.
4. DIMENSION b AND b2 DOES NOT INCLUDE DAMBAR PROTRUSION. LEAD WIDTH INCLUDING PROTRUSION SHALL NOT EXCEED 0.20. DIMENSION b2 LOCATED ABOVE THE DAMBAR PORTION OF MIDDLE LEAD.

DIM	MILLIMETERS		
	MIN.	NOM.	MAX.
A	3.75	3.90	4.05
A1	1.28	1.43	1.58
b	0.38	0.465	0.55
b2	0.62	0.70	0.78
c	0.35	0.40	0.45
D	7.85	8.00	8.15
E	4.75	4.90	5.05
E2	3.90	---	---
e	2.50 BSC		
L	13.80	14.00	14.20
L2	13.20	13.60	14.00
L3	3.00 REF		

**STYLES AND MARKING ON PAGE 3**

<b>DOCUMENT NUMBER:</b>	<b>98AON52857E</b>	Electronic versions are uncontrolled except when accessed directly from the Document Repository. Printed versions are uncontrolled except when stamped "CONTROLLED COPY" in red.
<b>DESCRIPTION:</b>	<b>TO-92 (TO-226) 1 WATT</b>	<b>PAGE 2 OF 3</b>

ON Semiconductor and  are trademarks of Semiconductor Components Industries, LLC dba ON Semiconductor or its subsidiaries in the United States and/or other countries. ON Semiconductor reserves the right to make changes without further notice to any products herein. ON Semiconductor makes no warranty, representation or guarantee regarding the suitability of its products for any particular purpose, nor does ON Semiconductor assume any liability arising out of the application or use of any product or circuit, and specifically disclaims any and all liability, including without limitation special, consequential or incidental damages. ON Semiconductor does not convey any license under its patent rights nor the rights of others.

**TO-92 (TO-226) 1 WATT  
CASE 29-10  
ISSUE D**

DATE 05 MAR 2021

- |   |  |  |   |   |
|---|--|--|---|---|
| STYLE 1:<br>PIN 1. EMITTER<br>2. BASE<br>3. COLLECTOR           | STYLE 2:<br>PIN 1. BASE<br>2. EMITTER<br>3. COLLECTOR                | STYLE 3:<br>PIN 1. ANODE<br>2. ANODE<br>3. CATHODE           | STYLE 4:<br>PIN 1. CATHODE<br>2. CATHODE<br>3. ANODE            | STYLE 5:<br>PIN 1. DRAIN<br>2. SOURCE<br>3. GATE            |
| STYLE 6:<br>PIN 1. GATE<br>2. SOURCE & SUBSTRATE<br>3. DRAIN    | STYLE 7:<br>PIN 1. SOURCE<br>2. DRAIN<br>3. GATE                     | STYLE 8:<br>PIN 1. DRAIN<br>2. GATE<br>3. SOURCE & SUBSTRATE | STYLE 9:<br>PIN 1. BASE 1<br>2. EMITTER<br>3. BASE 2            | STYLE 10:<br>PIN 1. CATHODE<br>2. GATE<br>3. ANODE          |
| STYLE 11:<br>PIN 1. ANODE<br>2. CATHODE & ANODE<br>3. CATHODE   | STYLE 12:<br>PIN 1. MAIN TERMINAL 1<br>2. GATE<br>3. MAIN TERMINAL 2 | STYLE 13:<br>PIN 1. ANODE 1<br>2. GATE<br>3. CATHODE 2       | STYLE 14:<br>PIN 1. EMITTER<br>2. COLLECTOR<br>3. BASE          | STYLE 15:<br>PIN 1. ANODE 1<br>2. CATHODE<br>3. ANODE 2     |
| STYLE 16:<br>PIN 1. ANODE<br>2. GATE<br>3. CATHODE              | STYLE 17:<br>PIN 1. COLLECTOR<br>2. BASE<br>3. EMITTER               | STYLE 18:<br>PIN 1. ANODE<br>2. CATHODE<br>3. NOT CONNECTED  | STYLE 19:<br>PIN 1. GATE<br>2. ANODE<br>3. CATHODE              | STYLE 20:<br>PIN 1. NOT CONNECTED<br>2. CATHODE<br>3. ANODE |
| STYLE 21:<br>PIN 1. COLLECTOR<br>2. EMITTER<br>3. BASE          | STYLE 22:<br>PIN 1. SOURCE<br>2. GATE<br>3. DRAIN                    | STYLE 23:<br>PIN 1. GATE<br>2. SOURCE<br>3. DRAIN            | STYLE 24:<br>PIN 1. EMITTER<br>2. COLLECTOR/ANODE<br>3. CATHODE | STYLE 25:<br>PIN 1. MT 1<br>2. GATE<br>3. MT 2              |
| STYLE 26:<br>PIN 1. V <sub>CC</sub><br>2. GROUND 2<br>3. OUTPUT | STYLE 27:<br>PIN 1. MT<br>2. SUBSTRATE<br>3. MT                      | STYLE 28:<br>PIN 1. CATHODE<br>2. ANODE<br>3. GATE           | STYLE 29:<br>PIN 1. NOT CONNECTED<br>2. ANODE<br>3. CATHODE     | STYLE 30:<br>PIN 1. DRAIN<br>2. GATE<br>3. SOURCE           |
| STYLE 31:<br>PIN 1. GATE<br>2. DRAIN<br>3. SOURCE               | STYLE 32:<br>PIN 1. BASE<br>2. COLLECTOR<br>3. EMITTER               | STYLE 33:<br>PIN 1. RETURN<br>2. INPUT<br>3. OUTPUT          | STYLE 34:<br>PIN 1. INPUT<br>2. GROUND<br>3. LOGIC              | STYLE 35:<br>PIN 1. GATE<br>2. COLLECTOR<br>3. EMITTER      |

**GENERIC  
MARKING DIAGRAM\***



- XXXX = Specific Device Code  
A = Assembly Location  
L = Wafer Lot  
Y = Year  
W = Work Week  
▪ = Pb-Free Package

(Note: Microdot may be in either location)

\*This information is generic. Please refer to device data sheet for actual part marking. Pb-Free indicator, "G" or microdot "▪", may or may not be present. Some products may not follow the Generic Marking.

<b>DOCUMENT NUMBER:</b>	<b>98AON52857E</b>	Electronic versions are uncontrolled except when accessed directly from the Document Repository. Printed versions are uncontrolled except when stamped "CONTROLLED COPY" in red.
<b>DESCRIPTION:</b>	<b>TO-92 (TO-226) 1 WATT</b>	<b>PAGE 3 OF 3</b>

ON Semiconductor and  are trademarks of Semiconductor Components Industries, LLC dba ON Semiconductor or its subsidiaries in the United States and/or other countries. ON Semiconductor reserves the right to make changes without further notice to any products herein. ON Semiconductor makes no warranty, representation or guarantee regarding the suitability of its products for any particular purpose, nor does ON Semiconductor assume any liability arising out of the application or use of any product or circuit, and specifically disclaims any and all liability, including without limitation special, consequential or incidental damages. ON Semiconductor does not convey any license under its patent rights nor the rights of others.

**onsemi**, **Onsemi**, and other names, marks, and brands are registered and/or common law trademarks of Semiconductor Components Industries, LLC dba "**onsemi**" or its affiliates and/or subsidiaries in the United States and/or other countries. **onsemi** owns the rights to a number of patents, trademarks, copyrights, trade secrets, and other intellectual property. A listing of **onsemi**'s product/patent coverage may be accessed at [www.onsemi.com/site/pdf/Patent-Marking.pdf](http://www.onsemi.com/site/pdf/Patent-Marking.pdf). **onsemi** reserves the right to make changes at any time to any products or information herein, without notice. The information herein is provided "as-is" and **onsemi** makes no warranty, representation or guarantee regarding the accuracy of the information, product features, availability, functionality, or suitability of its products for any particular purpose, nor does **onsemi** assume any liability arising out of the application or use of any product or circuit, and specifically disclaims any and all liability, including without limitation special, consequential or incidental damages. Buyer is responsible for its products and applications using **onsemi** products, including compliance with all laws, regulations and safety requirements or standards, regardless of any support or applications information provided by **onsemi**. "Typical" parameters which may be provided in **onsemi** data sheets and/or specifications can and do vary in different applications and actual performance may vary over time. All operating parameters, including "Typicals" must be validated for each customer application by customer's technical experts. **onsemi** does not convey any license under any of its intellectual property rights nor the rights of others. **onsemi** products are not designed, intended, or authorized for use as a critical component in life support systems or any FDA Class 3 medical devices or medical devices with a same or similar classification in a foreign jurisdiction or any devices intended for implantation in the human body. Should Buyer purchase or use **onsemi** products for any such unintended or unauthorized application, Buyer shall indemnify and hold **onsemi** and its officers, employees, subsidiaries, affiliates, and distributors harmless against all claims, costs, damages, and expenses, and reasonable attorney fees arising out of, directly or indirectly, any claim of personal injury or death associated with such unintended or unauthorized use, even if such claim alleges that **onsemi** was negligent regarding the design or manufacture of the part. **onsemi** is an Equal Opportunity/Affirmative Action Employer. This literature is subject to all applicable copyright laws and is not for resale in any manner.

## ADDITIONAL INFORMATION

### TECHNICAL PUBLICATIONS:

Technical Library: [www.onsemi.com/design/resources/technical-documentation](http://www.onsemi.com/design/resources/technical-documentation)  
onsemi Website: [www.onsemi.com](http://www.onsemi.com)

### ONLINE SUPPORT: [www.onsemi.com/support](http://www.onsemi.com/support)

For additional information, please contact your local Sales Representative at [www.onsemi.com/support/sales](http://www.onsemi.com/support/sales)