

NPN Epitaxial Silicon Transistor

KSD1616A

Features

- Audio Frequency Power Amplifier and Medium Speed Switching
- Complement to KSB1116/KSB1116A
- These are Pb-Free Devices

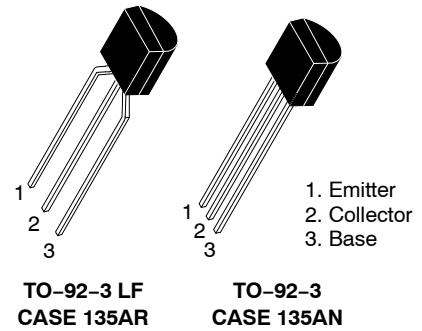

ABSOLUTE MAXIMUM RATINGS

(Values are at $T_A = 25^\circ\text{C}$ unless otherwise noted.)

Symbol	Parameter	Value	Unit
V_{CBO}	Collector-Base Voltage	120	V
V_{CEO}	Collector-Emitter Voltage	60	V
V_{EBO}	Emitter-Base Voltage	6	V
I_C	Collector Current (DC)	1	A
I_{CP}	Collector Current (Pulse) (Note 1)	2	A
T_J	Junction Temperature	150	$^\circ\text{C}$
T_{STG}	Storage Temperature	-55 to 150	$^\circ\text{C}$

Stresses exceeding those listed in the Maximum Ratings table may damage the device. If any of these limits are exceeded, device functionality should not be assumed, damage may occur and reliability may be affected.

1. Pulse width ≤ 10 ms, duty cycle $< 50\%$.

THERMAL CHARACTERISTICS

(Values are at $T_A = 25^\circ\text{C}$ unless otherwise noted.)

Symbol	Parameter	Max	Unit
P_D	Total Device Dissipation	0.75	W
	Derate Above 25°C	6	mW/ $^\circ\text{C}$
$R_{\theta JA}$	Thermal Resistance, Junction-to-Ambient	160	$^\circ\text{C}/\text{W}$

2. PCB size: FR-4, 76 mm \times 114 mm \times 1.57 mm (3.0 inch \times 4.5 inch \times 0.062 inch) with minimum land pattern size.

MARKING DIAGRAM

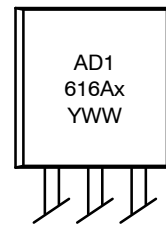

A = Assembly Location
D1616Ax = Specific Device Code
x = G or Y
Y = Year of Production
WW = Work Week Number

ORDERING INFORMATION

Device	Package	Shipping
KSD1616AGBU	TO-92-3 (Pb-Free)	10,000 Units / Bulk Bag
KSD1616AGTA	TO-92-3 LF (Pb-Free)	2,000 Units / Fan-Fold
KSD1616AYTA	TO-92-3 LF (Pb-Free)	2,000 Units / Fan-Fold

KSD1616A

ELECTRICAL CHARACTERISTICS

(Values are at $T_A = 25^\circ\text{C}$ unless otherwise noted.)

Symbol	Parameter	Conditions	Min	Typ	Max	Unit
BV_{CBO}	Collector-Base Breakdown Voltage	$I_C = 100 \mu\text{A}, I_E = 0$	120	-	-	V
BV_{CEO}	Collector-Emitter Breakdown Voltage	$I_C = 1 \text{ mA}, I_B = 0$	60	-	-	V
BV_{EBO}	Emitter-Base Breakdown Voltage	$I_E = 100 \mu\text{A}, I_C = 0$	6	-	-	V
I_{CBO}	Collector Cut-Off Current	$V_{CB} = 60 \text{ V}, I_E = 0$	-	-	100	nA
I_{EBO}	Emitter Cut-Off Current	$V_{EB} = 6 \text{ V}, I_C = 0$	-	-	100	nA
h_{FE1}	DC Current Gain	$V_{CE} = 2 \text{ V}, I_C = 100 \text{ mA}$	135	-	400	
h_{FE2}	DC Current Gain	$V_{CE} = 2 \text{ V}, I_C = 1 \text{ A}$	81	-	-	
$V_{BE(on)}$	Base-Emitter On Voltage (Note 3)	$V_{CE} = 2 \text{ V}, I_C = 50 \text{ mA}$	600	640	700	mV
$V_{CE(sat)}$	Collector-Emitter Saturation Voltage (Note 3)	$I_C = 1 \text{ A}, I_B = 50 \text{ mA}$	-	0.15	0.30	V
$V_{BE(sat)}$	Base-Emitter Saturation Voltage (Note 3)	$I_C = 1 \text{ A}, I_B = 50 \text{ mA}$	-	0.9	1.2	V
C_{ob}	Output Capacitance	$V_{CE} = 10 \text{ V}, I_E = 0, f = 1 \text{ MHz}$	-	19	-	pF
f_T	Current Gain Bandwidth Product	$V_{CE} = 2 \text{ V}, I_C = 100 \text{ mA}$	100	160	-	MHz
t_{ON}	Turn-On Time	$V_{CC} = 10 \text{ V}, I_C = 100 \text{ mA},$ $I_{B1} = -I_{B2} = 10 \text{ mA},$ $V_{BE(off)} = -2 \text{ V} \sim -3 \text{ V}$	-	0.07	-	μs
t_{STG}	Storage Time		-	0.95	-	μs
t_F	Fall Time		-	0.07	-	μs

Product parametric performance is indicated in the Electrical Characteristics for the listed test conditions, unless otherwise noted. Product performance may not be indicated by the Electrical Characteristics if operated under different conditions.

3. Pulse test: pulse width $< 350 \mu\text{s}$, duty cycle $\leq 2\%$ pulsed.

h_{FE} CLASSIFICATION

Classification	Y	G
h_{FE1}	135 ~ 270	200 ~ 400

KSD1616A

TYPICAL PERFORMANCE CHARACTERISTICS

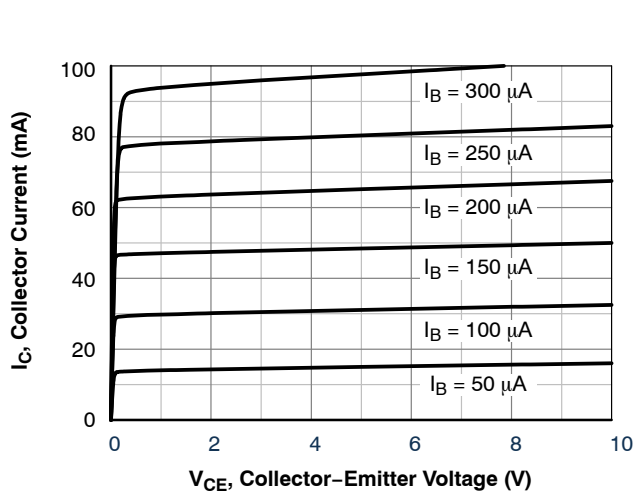

Figure 1. Static Characteristic

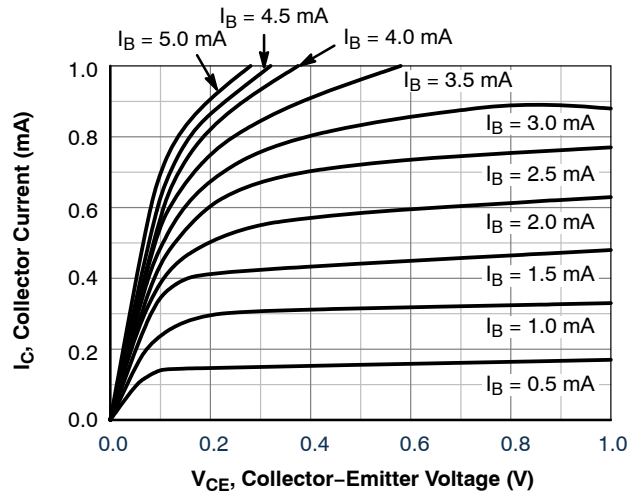

Figure 2. Static Characteristic

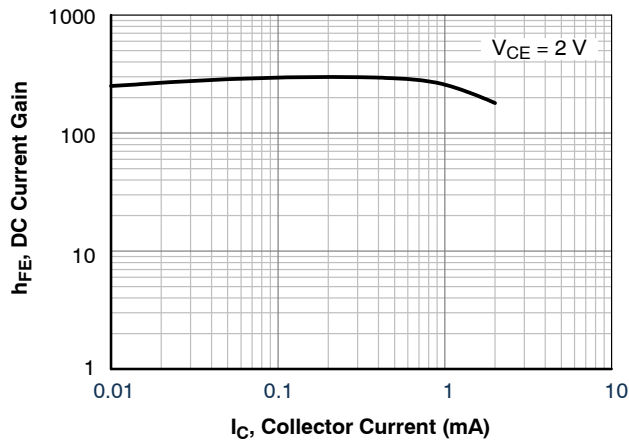

Figure 3. DC Current Gain

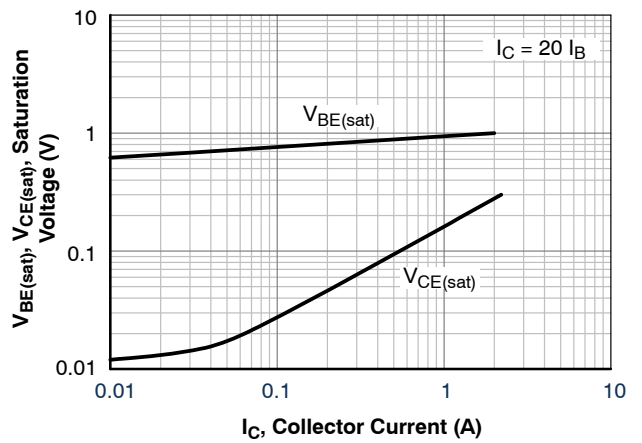

Figure 4. Base-Emitter Saturation Voltage and Collector-Emitter Saturation Voltage

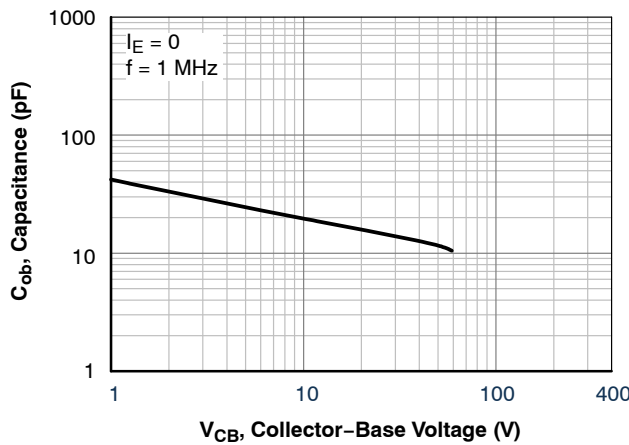

Figure 5. Collector Output Capacitance

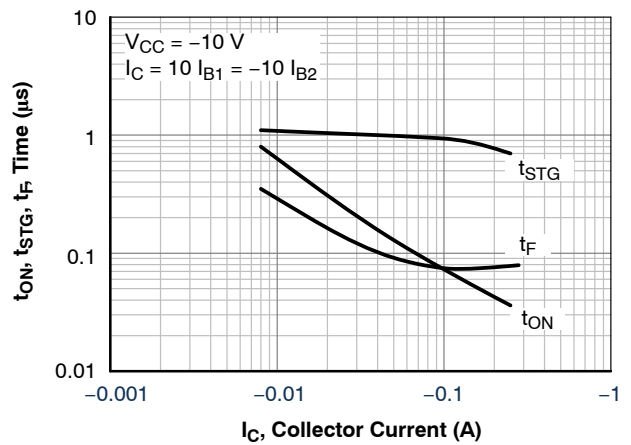

Figure 6. Switching Time

KSD1616A

TYPICAL CHARACTERISTICS (continued)

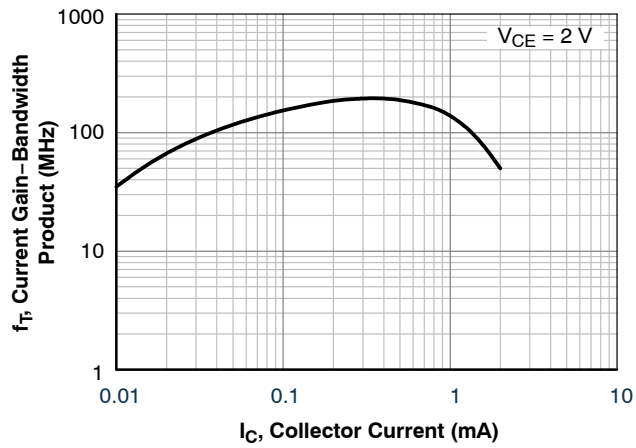

Figure 7. Current Gain Bandwidth Product

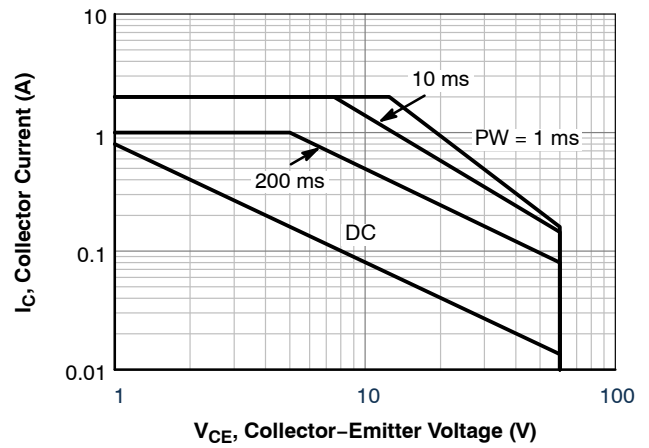

Figure 8. Safe Operating Area

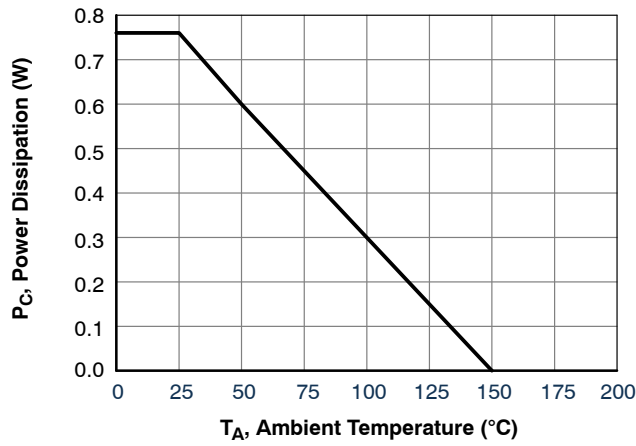

Figure 9. Power Derating

MECHANICAL CASE OUTLINE
PACKAGE DIMENSIONS

TO-92 3 4.825x4.76
CASE 135AN
ISSUE O

DATE 31 JUL 2016



NOTES: UNLESS OTHERWISE SPECIFIED

- A) DRAWING WITH REFERENCE TO JEDEC TO-92 RECOMMENDATIONS.
- B) ALL DIMENSIONS ARE IN MILLIMETERS.
- C) DRAWING CONFORMS TO ASME Y14.5M-2009.

DOCUMENT NUMBER:	98AON13880G	Electronic versions are uncontrolled except when accessed directly from the Document Repository. Printed versions are uncontrolled except when stamped "CONTROLLED COPY" in red.
DESCRIPTION:	TO-92 3 4.825X4.76	PAGE 1 OF 1

ON Semiconductor and **ON** are trademarks of Semiconductor Components Industries, LLC dba ON Semiconductor or its subsidiaries in the United States and/or other countries. ON Semiconductor reserves the right to make changes without further notice to any products herein. ON Semiconductor makes no warranty, representation or guarantee regarding the suitability of its products for any particular purpose, nor does ON Semiconductor assume any liability arising out of the application or use of any product or circuit, and specifically disclaims any and all liability, including without limitation special, consequential or incidental damages. ON Semiconductor does not convey any license under its patent rights nor the rights of others.

TO-92 3 4.83x4.76 LEADFORMED
CASE 135AR
ISSUE O

DATE 30 SEP 2016



NOTES: UNLESS OTHERWISE SPECIFIED

- A) DRAWING WITH REFERENCE TO JEDEC TO-92 RECOMMENDATIONS.
- B) ALL DIMENSIONS ARE IN MILLIMETERS.
- C) DRAWING CONFORMS TO ASME Y14.5M-1994

DOCUMENT NUMBER:	98AON13879G	Electronic versions are uncontrolled except when accessed directly from the Document Repository. Printed versions are uncontrolled except when stamped "CONTROLLED COPY" in red.
DESCRIPTION:	TO-92 3 4.83X4.76 LEADFORMED	PAGE 1 OF 1

ON Semiconductor and  are trademarks of Semiconductor Components Industries, LLC dba ON Semiconductor or its subsidiaries in the United States and/or other countries. ON Semiconductor reserves the right to make changes without further notice to any products herein. ON Semiconductor makes no warranty, representation or guarantee regarding the suitability of its products for any particular purpose, nor does ON Semiconductor assume any liability arising out of the application or use of any product or circuit, and specifically disclaims any and all liability, including without limitation special, consequential or incidental damages. ON Semiconductor does not convey any license under its patent rights nor the rights of others.

onsemi, **Onsemi**, and other names, marks, and brands are registered and/or common law trademarks of Semiconductor Components Industries, LLC dba "**onsemi**" or its affiliates and/or subsidiaries in the United States and/or other countries. **onsemi** owns the rights to a number of patents, trademarks, copyrights, trade secrets, and other intellectual property. A listing of **onsemi**'s product/patent coverage may be accessed at www.onsemi.com/site/pdf/Patent-Marking.pdf. **onsemi** reserves the right to make changes at any time to any products or information herein, without notice. The information herein is provided "as-is" and **onsemi** makes no warranty, representation or guarantee regarding the accuracy of the information, product features, availability, functionality, or suitability of its products for any particular purpose, nor does **onsemi** assume any liability arising out of the application or use of any product or circuit, and specifically disclaims any and all liability, including without limitation special, consequential or incidental damages. Buyer is responsible for its products and applications using **onsemi** products, including compliance with all laws, regulations and safety requirements or standards, regardless of any support or applications information provided by **onsemi**. "Typical" parameters which may be provided in **onsemi** data sheets and/or specifications can and do vary in different applications and actual performance may vary over time. All operating parameters, including "Typicals" must be validated for each customer application by customer's technical experts. **onsemi** does not convey any license under any of its intellectual property rights nor the rights of others. **onsemi** products are not designed, intended, or authorized for use as a critical component in life support systems or any FDA Class 3 medical devices or medical devices with a same or similar classification in a foreign jurisdiction or any devices intended for implantation in the human body. Should Buyer purchase or use **onsemi** products for any such unintended or unauthorized application, Buyer shall indemnify and hold **onsemi** and its officers, employees, subsidiaries, affiliates, and distributors harmless against all claims, costs, damages, and expenses, and reasonable attorney fees arising out of, directly or indirectly, any claim of personal injury or death associated with such unintended or unauthorized use, even if such claim alleges that **onsemi** was negligent regarding the design or manufacture of the part. **onsemi** is an Equal Opportunity/Affirmative Action Employer. This literature is subject to all applicable copyright laws and is not for resale in any manner.

ADDITIONAL INFORMATION

TECHNICAL PUBLICATIONS:

Technical Library: www.onsemi.com/design/resources/technical-documentation
onsemi Website: www.onsemi.com

ONLINE SUPPORT: www.onsemi.com/support

For additional information, please contact your local Sales Representative at www.onsemi.com/support/sales