



2SA2012

Bipolar Transistor -30V, -5A, Low VCE(sat) PNP Single PCP

ON Semiconductor®

<http://onsemi.com>

Applications

- Relay drivers, lamp drivers, motor drivers, flash

Features

- Adoption of MBIT processes
- Low collector to emitter saturation voltage
- Ultrasmall-sized package permitting applied sets to be made small and slim
- High allowable power dissipation
- Large current capacity

Specifications

Absolute Maximum Ratings at Ta=25°C

Parameter	Symbol	Conditions	Ratings	Unit
Collector to Base Voltage	VCBO		-30	V
Collector to Emitter Voltage	VCEO		-30	V
Emitter to Base Voltage	VEBO		-5	V
Collector Current	IC		-5	A
Collector Current (Pulse)	ICP		-8	A

Continued on next page.

Stresses exceeding Maximum Ratings may damage the device. Maximum Ratings are stress ratings only. Functional operation above the Recommended Operating Conditions is not implied. Extended exposure to stresses above the Recommended Operating Conditions may affect device reliability.

Package Dimensions

unit : mm (typ)

7007B-004

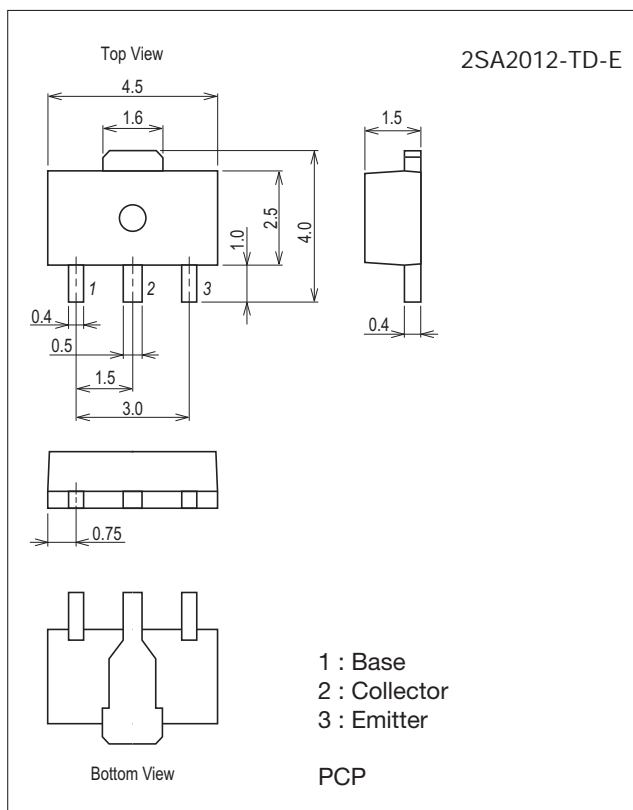

Product & Package Information

- Package : PCP
- JEITA, JEDEC : SC-62, SOT-89, TO-243
- Minimum Packing Quantity : 1,000 pcs./reel

Packing Type: TD

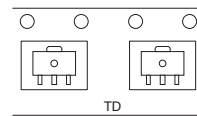

Marking

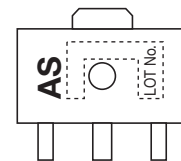

Electrical Connection

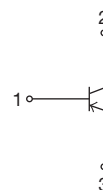

2SA2012

Continued from preceding page.

Parameter	Symbol	Conditions	Ratings	Unit
Base Current	I_B		-600	mA
Collector Dissipation	P_C	When mounted on ceramic substrate (250mm ² ×0.8mm)	1.3	W
		$T_C=25^\circ\text{C}$	3.5	W
Junction Temperature	T_j		150	$^\circ\text{C}$
Storage Temperature	T_{stg}		-55 to +150	$^\circ\text{C}$

Electrical Characteristics at $T_a=25^\circ\text{C}$

Parameter	Symbol	Conditions	Ratings			Unit
			min	typ	max	
Collector Cutoff Current	I_{CBO}	$V_{CB}=-30\text{V}, I_E=0\text{A}$			-0.1	μA
Emitter Cutoff Current	I_{EBO}	$V_{EB}=-4\text{V}, I_C=0\text{A}$			-0.1	μA
DC Current Gain	h_{FE}	$V_{CE}=-2\text{V}, I_C=-500\text{mA}$	200		560	
Gain-Bandwidth Product	f_T	$V_{CE}=-10\text{V}, I_C=-500\text{mA}$		350		MHz
Output Capacitance	C_{ob}	$V_{CB}(-)10\text{V}, f=1\text{MHz}$		30		pF
Collector to Emitter Saturation Voltage	$V_{CE(sat)1}$	$I_C=-1.5\text{A}, I_B=-30\text{mA}$		-140	-210	mV
	$V_{CE(sat)2}$	$I_C=-2.5\text{A}, I_B=-125\text{mA}$		-170	-260	mV
Base to Emitter Saturation Voltage	$V_{BE(sat)}$	$I_C=-1.5\text{A}, I_B=-30\text{mA}$		-0.83	-1.2	V
Collector to Base Breakdown Voltage	$V_{(BR)CBO}$	$I_C=-10\mu\text{A}, I_E=0\text{A}$	-30			V
Collector to Emitter Breakdown Voltage	$V_{(BR)CEO}$	$I_C=-1\text{mA}, R_{BE}=\infty$	-30			V
Emitter to Base Breakdown Voltage	$V_{(BR)EBO}$	$I_E=-10\mu\text{A}, I_C=0\text{A}$	-5			V
Turn-ON Time	t_{on}			50		ns
Storage Time	t_{stg}	See specified Test Circuit.		270		ns
Fall Time	t_f			25		ns

Switching Time Test Circuit

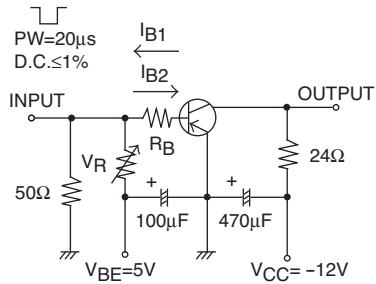

$$I_C=20I_{B1} = -20I_{B2} = -500\text{mA}$$

Ordering Information

Device	Package	Shipping	memo
2SA2012-TD-E	PCP	1,000pcs./reel	Pb Free

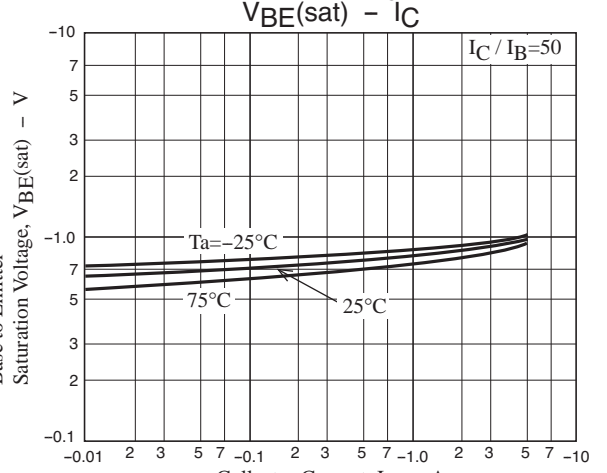
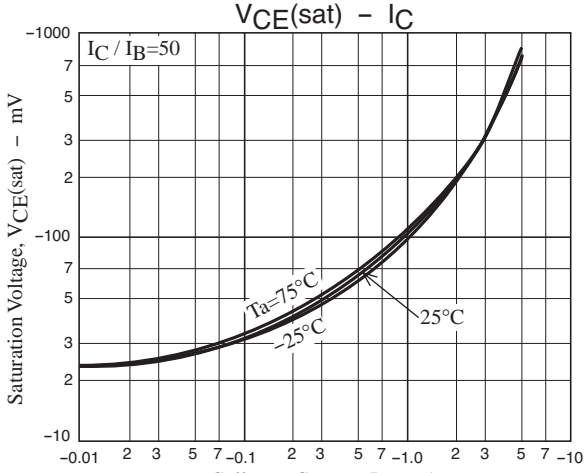
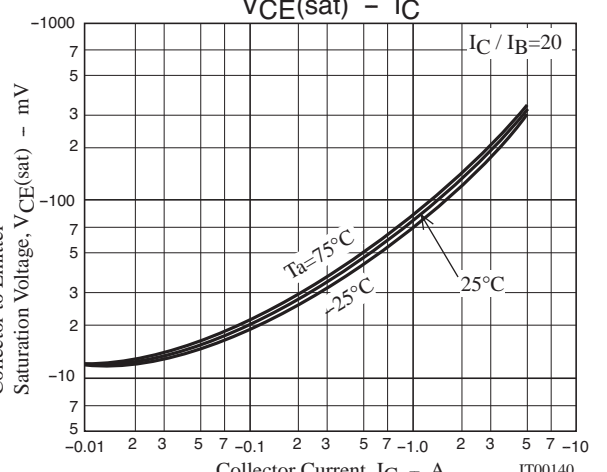
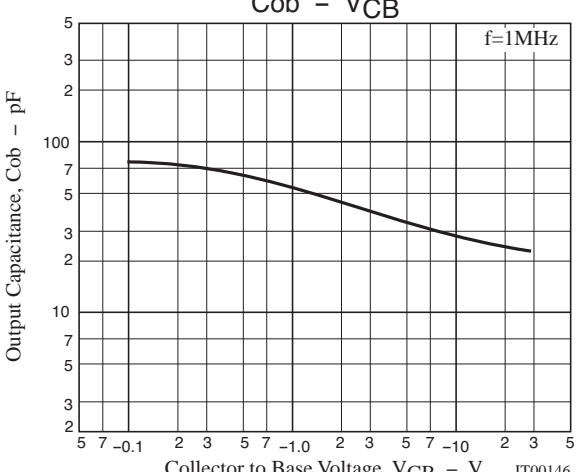
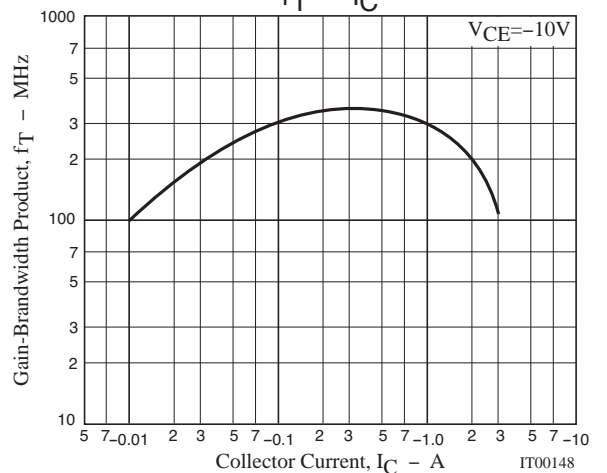
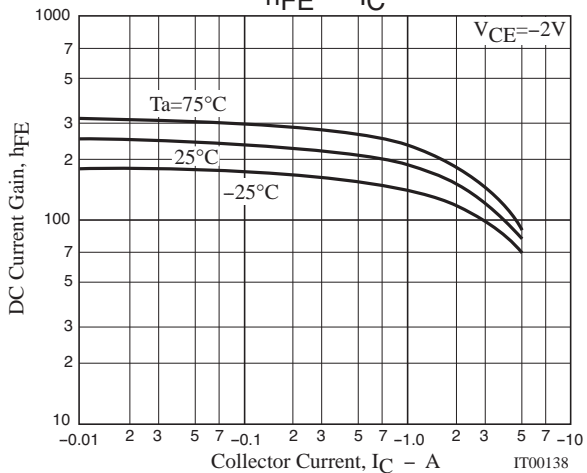
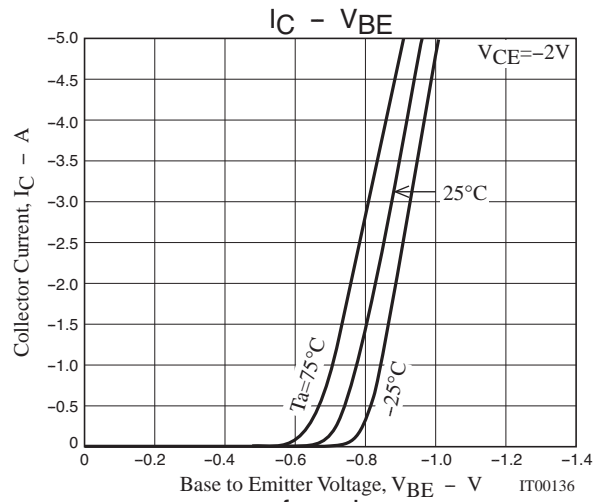
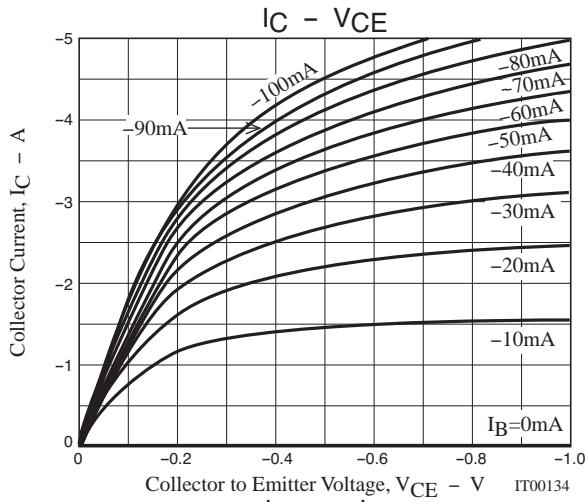

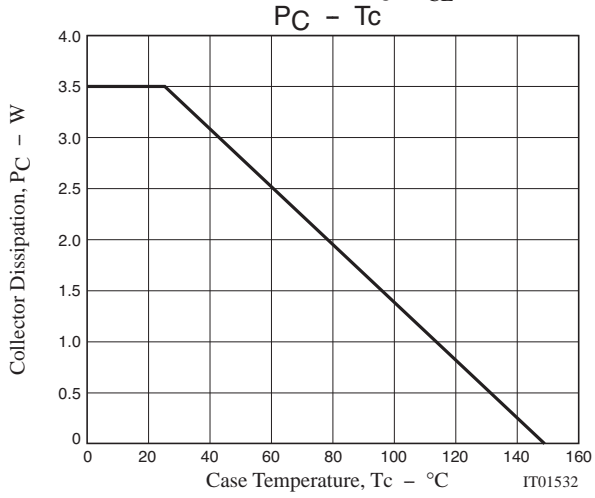
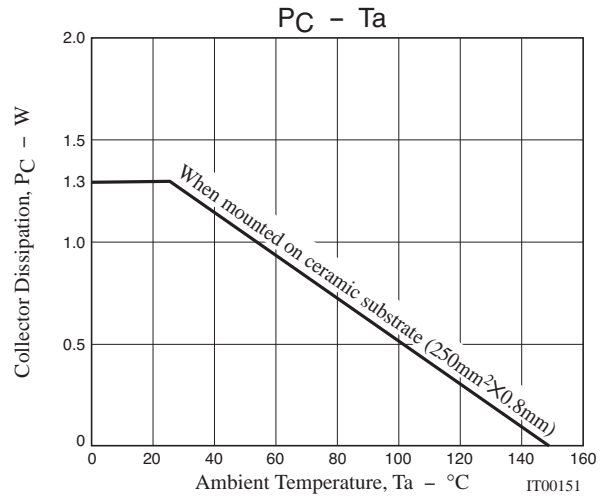
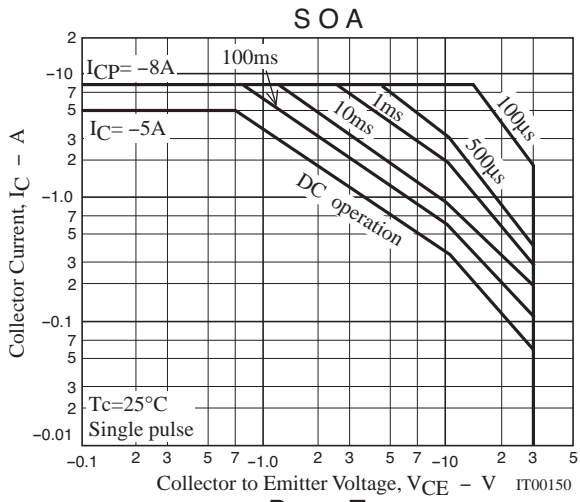

Outline Drawing

2SA2012-TD-E

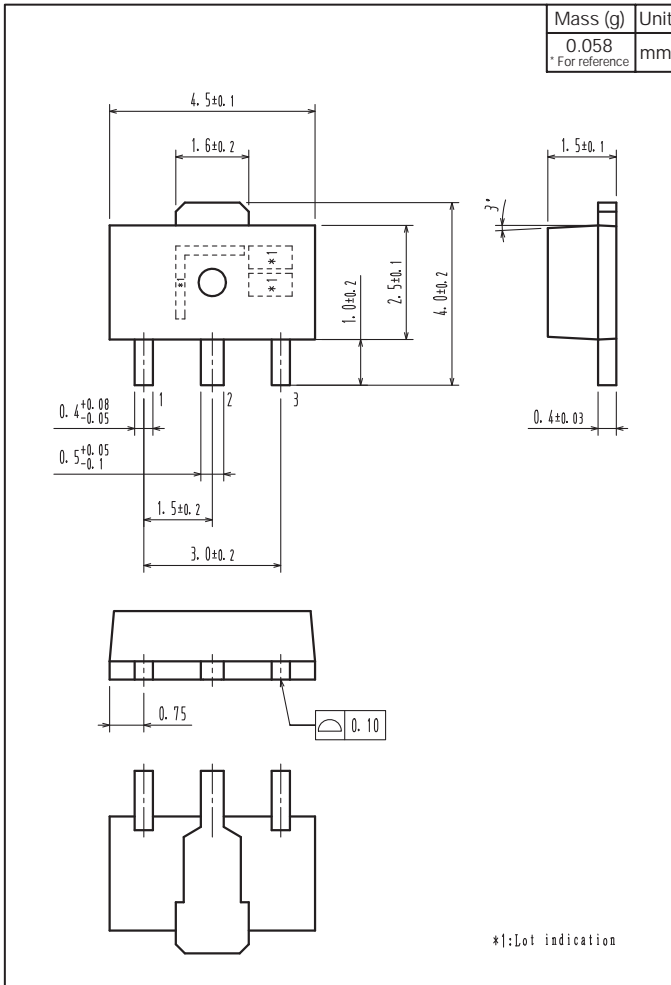

Land Pattern Example

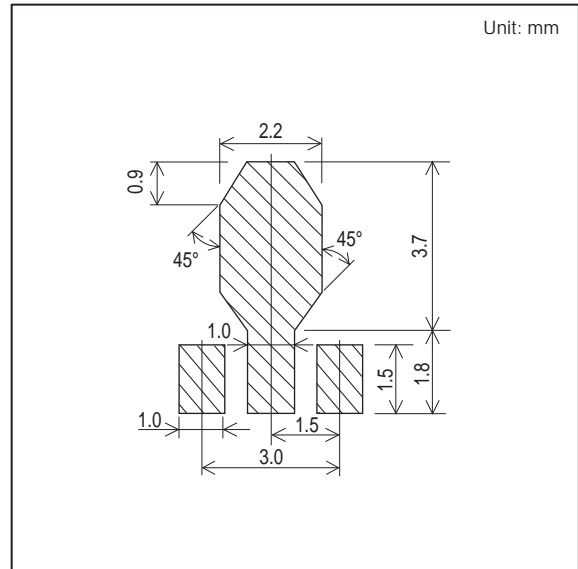

ON Semiconductor and the ON logo are registered trademarks of Semiconductor Components Industries, LLC (SCILLC). SCILLC owns the rights to a number of patents, trademarks, copyrights, trade secrets, and other intellectual property. A listing of SCILLC's product/patent coverage may be accessed at www.onsemi.com/site/pdf/Patent-Marking.pdf. SCILLC reserves the right to make changes without further notice to any products herein. SCILLC makes no warranty, representation or guarantee regarding the suitability of its products for any particular purpose, nor does SCILLC assume any liability arising out of the application or use of any product or circuit, and specifically disclaims any and all liability, including without limitation special, consequential or incidental damages. "Typical" parameters which may be provided in SCILLC data sheets and/or specifications can and do vary in different applications and actual performance may vary over time. All operating parameters, including "Typicals" must be validated for each customer application by customer's technical experts. SCILLC does not convey any license under its patent rights nor the rights of others. SCILLC products are not designed, intended, or authorized for use as components in systems intended for surgical implant into the body, or other applications intended to support or sustain life, or for any other application in which the failure of the SCILLC product could create a situation where personal injury or death may occur. Should Buyer purchase or use SCILLC products for any such unintended or unauthorized application, Buyer shall indemnify and hold SCILLC and its officers, employees, subsidiaries, affiliates, and distributors harmless against all claims, costs, damages, and expenses, and reasonable attorney fees arising out of, directly or indirectly, any claim of personal injury or death associated with such unintended or unauthorized use, even if such claim alleges that SCILLC was negligent regarding the design or manufacture of the part. SCILLC is an Equal Opportunity/Affirmative Action Employer. This literature is subject to all applicable copyright laws and is not for resale in any manner.