



Small Signal Transistor

-160V PNP
SOT23

Features

- Collector Current : $I_c = -600\text{mA}$
- Power Dissipation of 300mW
- High Stability and High Reliability

Mechanical Data

- Case: SOT23 Package
- Case Material: "Green" Molding Compound UL Flammability Classification Rating 94V-0
- Halogen Free

Note: Products with logo  or  are made by HY Electronic (Cayman) Limited.

Ordering Information

- Package :SOT23
- Reel Size :7 (inches)
- Quantity Per Reel :3,000 pcs
- Quantity One Box :45,000 pcs
- Quantity One Carton :180,000 pcs

Package Outline



SOT23 Top View

Marking Information

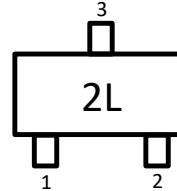

"2L" = Product Type Marking Code

Device Schematic & PIN Configuration

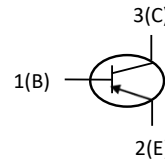

Pin Assignment	
1	Base
2	Emitter
3	Collector

Maximum Ratings (@TA = +25°C, unless otherwise specified.)

Parameter	Symbol	Value	Unit
Collector-Base Voltage	V_{CB0}	-160	V
Collector-Emitter Voltage	V_{CE0}	-150	
Emitter-Base Voltage	V_{EB0}	-5	
Collector Current-Continuous	I_c	-600	mA
Collector Power Dissipation	P_c	300	mW
Thermal Resistance from Junction to Ambient	$R_{\theta JA}$	416	°C/W
Junction Temperature	T_j	150	°C
Storage Temperature Range	T_{STG}	-55 to +150	°C

Electrical Characteristics(@TA = +25°C, unless otherwise specified.)

Parameter	Test Conditions	Symbol	Min	Max	Unit
Collector-Base Breakdown Voltage	$I_c = -100\mu\text{A}, I_E = 0$	$V_{(BR)CB0}$	-160	-	V
Collector-Emitter Breakdown Voltage	$I_c = -1\text{mA}, I_B = 0$	$V_{(BR)CE0^*}$	-150	-	
Emitter-Base Breakdown Voltage	$I_E = -10\mu\text{A}, I_c = 0$	$V_{(BR)EB0}$	-5	-	
Collector Cut-Off Current	$V_{CB} = -120\text{V}, I_E = 0$	I_{cBO}	-	-100	nA
Emitter Cut-Off Current	$V_{EB} = -4\text{V}, I_c = 0$	I_{eBO}	-	-100	nA
DC Current Gain	$V_{CE} = -5\text{V}, I_c = -1\text{mA}$	$h_{FE(1)^*}$	80	-	-
	$V_{CE} = -5\text{V}, I_c = -10\text{mA}$	$h_{FE(2)^*}$	100	300	
	$V_{CE} = -5\text{V}, I_c = -50\text{mA}$	$h_{FE(3)^*}$	30	-	
Collector-Emitter Saturation Voltage	$I_c = -10\text{mA}, I_B = -1\text{mA}$	$V_{CE(sat)1^*}$	-	-0.2	V
	$I_c = -50\text{mA}, I_B = -5\text{mA}$	$V_{CE(sat)2^*}$	-	-0.5	V
Base-Emitter Saturation Voltage	$I_c = -10\text{mA}, I_B = -1\text{mA}$	$V_{BE(sat)1^*}$	-	-1	V
	$I_c = -50\text{mA}, I_B = -5\text{mA}$	$V_{BE(sat)2^*}$	-	-1	V
Transition Frequency	$V_{CE} = -5\text{V}, I_c = 10\text{mA}, F = 30\text{MHz}$	f_T	100	-	MHz

Note : Pulse test : pulse width $\leq 300\mu\text{s}$, duty cycle $\leq 2.0\%$



Rating and Characteristic Curves

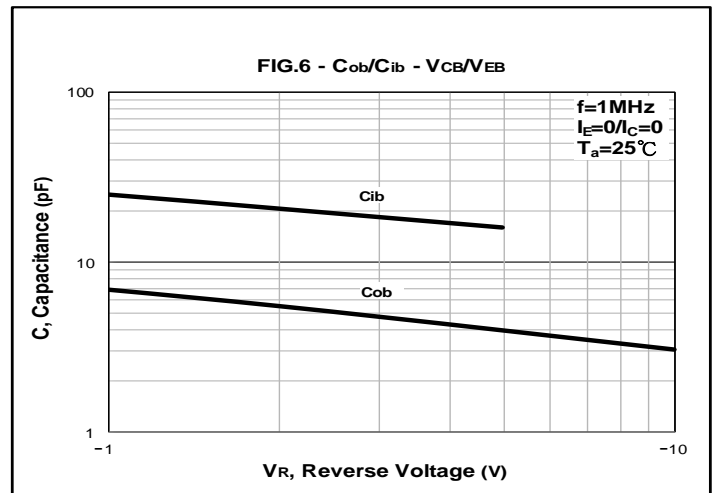
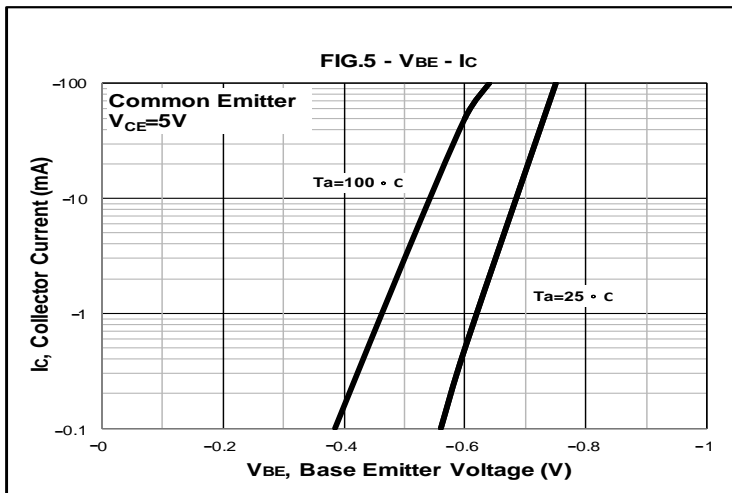
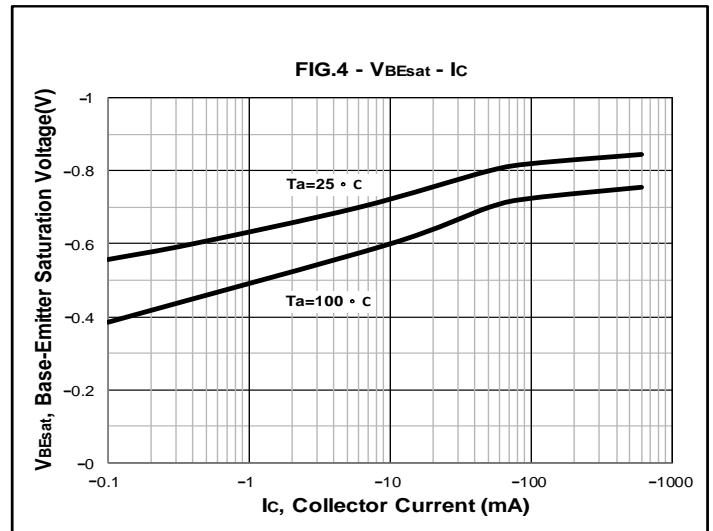
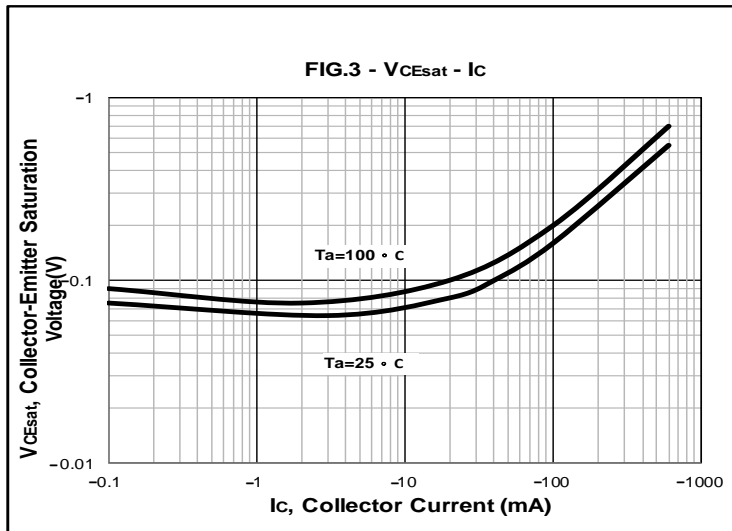
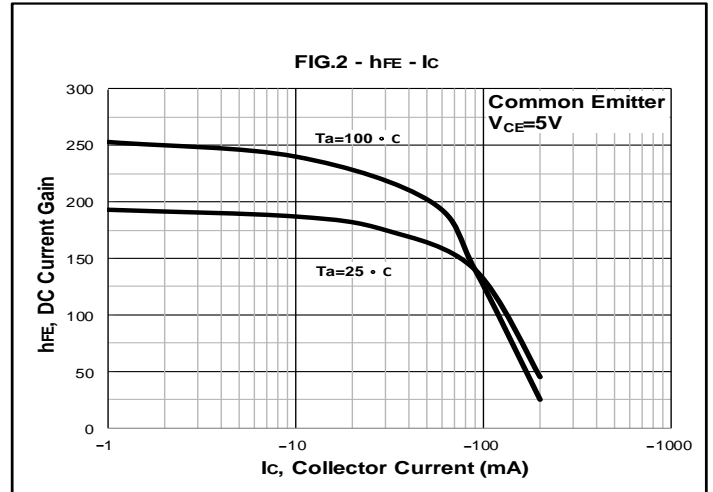
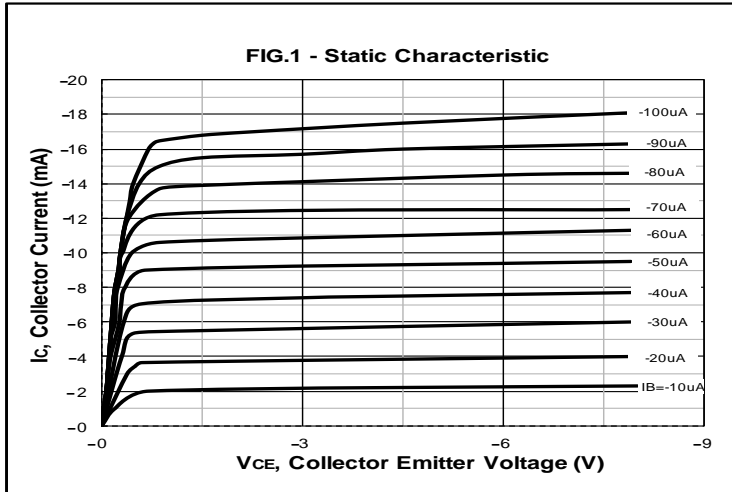



Rating and Characteristic Curves

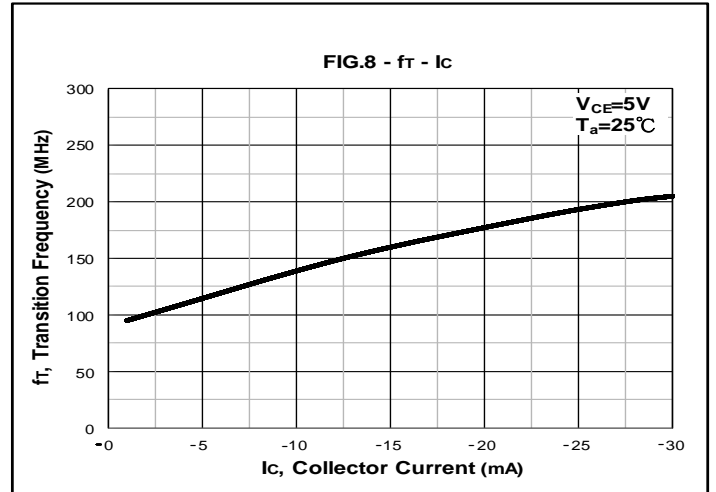
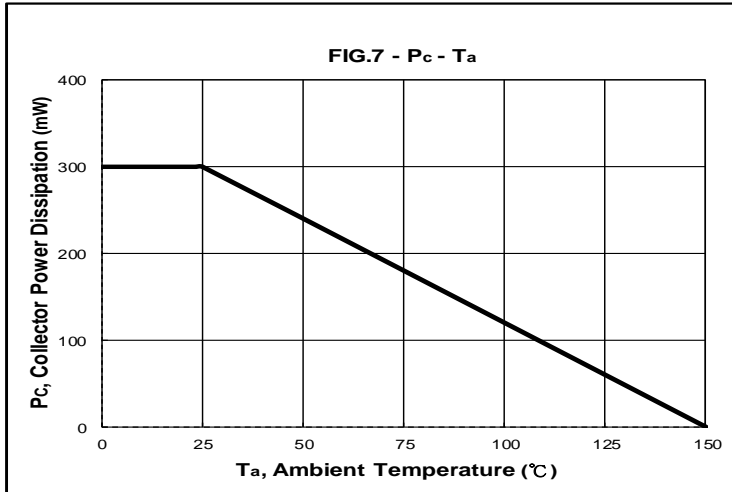



Package Outline Dimensions

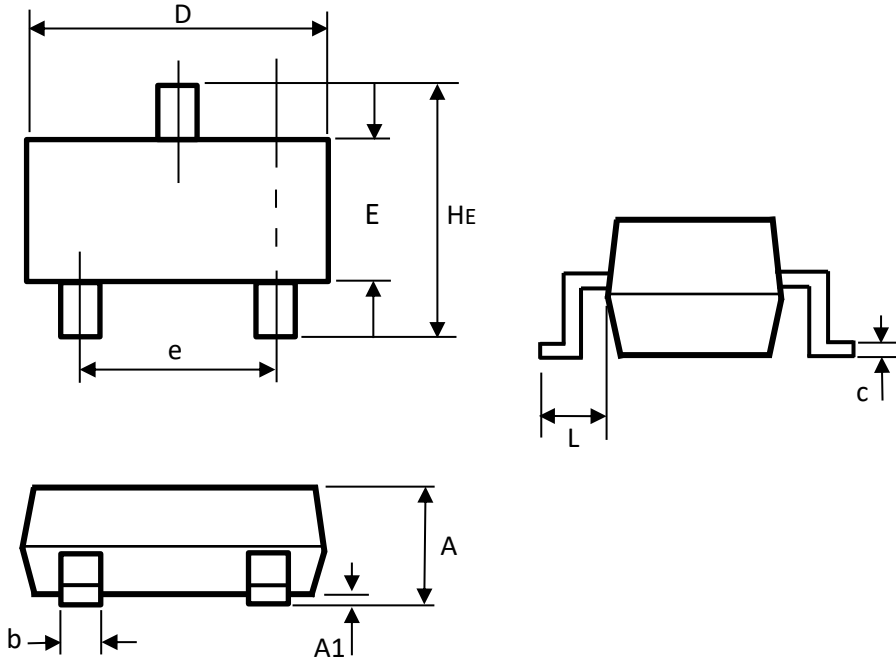

SOT23 Package		
Dim	Min	Max
A	0.90	1.15
A1	0.00	0.10
b	0.30	0.50
c	0.08	0.15
D	2.80	3.00
E	1.20	1.40
e	1.80	2.00
L	0.55 REF	
HE	2.25	2.55
All Dimensions in mm		

Suggested Soldering Pad Layout

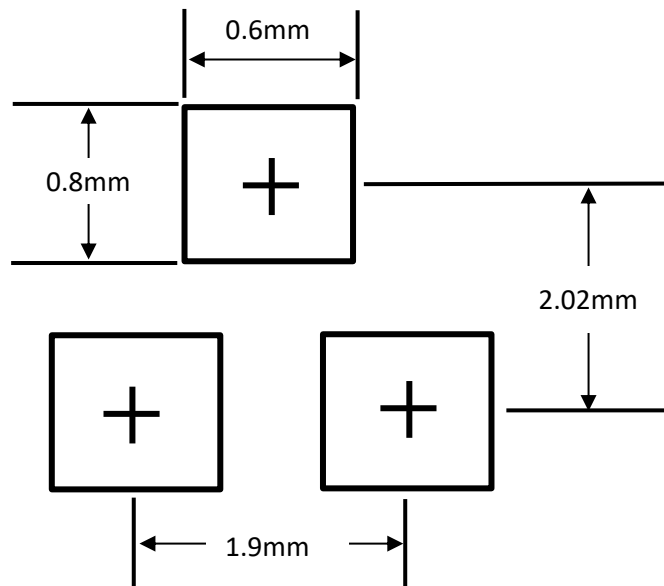

Note:

- 1.The pad layout is for reference purposes only.
- 2.General tolerance $\pm 0.05\text{mm}$



Disclaimer

All specifications and data are subject to be changed without notice to improve reliability function or design or other reasons.

HY makes no warranty, representation or guarantee regarding the suitability of the products for any particular purpose or the continuing production of any product. To the maximum extent permitted by applicable law, HY disclaims (i) any and all liability arising out of the application or use of any product, (ii) any and all liability, including without limitation special, consequential or incidental damages, and (iii) any and all implied warranties, including warranties of fitness for particular purpose, non-infringement and merchantability.

Statements regarding the suitability of products for certain types of applications are based on HY's knowledge of typical requirements that are often placed on HY products in generic applications. Such statements are not binding statements about the suitability of products for a particular application. It is the customer's responsibility to validate that a particular product with the properties described in the product specification is suitable for use in a particular application. Parameters provided in datasheets and specifications may vary in different applications and performance may vary over time. All operating parameters, including typical parameters, must be validated for each customer application by the customer's technical experts. Product specifications do not expand or otherwise modify HY's terms and conditions of purchase, including but not limited to the warranty expressed therein.

Except as expressly indicated in writing, HY products are not designed for use in medical, life-saving, or life-sustaining applications or for any other applications in which the failure of the HY product could result in personal injury or death. Customers using or selling HY products not expressly indicated for use in such applications do so at their own risk. Please contact authorized HY personnel to obtain written terms and conditions regarding products designed for such applications.

No license, express or implied, by estoppel or otherwise, to any intellectual property rights is granted by this document or by any conduct of HY. Product names and markings noted herein may be trademarks of their respective owners.