

SVxx12xx series

12 Amp High Junction Temperature SCRs

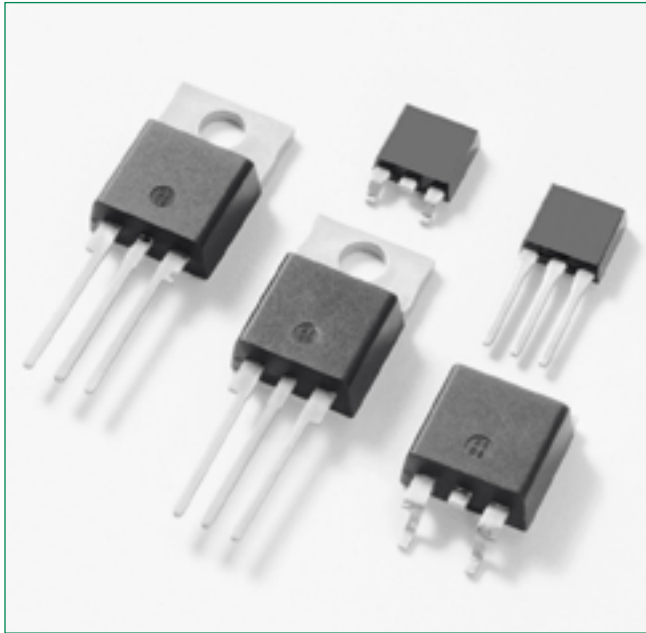

Description

The SVxx12xx high junction temperature SCR series is ideal for uni-directional switch applications such as phase control in heating, motor speed controls, converters/rectifiers, inrush current control and capacitive discharge ignitions.

These SCRs have a low gate current, (IGT) trigger level of 6mA and 10mA maximum at approximately 1.5V for SVxx12x1 and SVxx12x2, respectively.

Features & Benefits

- Halogen free and RoHS compliant
- 150°C maximum junction temperature
- Surge capability up to 120A at 60Hz half cycle
- High dv/dt performance
- Recognized to UL 1557 as an Electrically Semiconductor Device

Applications

Typical applications include AC Generator (ACG) rectifiers, battery voltage regulators and generic converters and inrush current controller in various AC to DC applications. Additional applications include controls for power tools, home/brown good and white goods appliances.

Internally constructed isolated packages offered for ease of heat sinking with high isolation voltage.

Agency Approval

Agency	Agency File Number
	E71639*

*L Packages only

Main Features

Symbol	Value	Unit
$I_{T(RMS)}$	12	A
V_{DRM}/V_{RRM}	600 to 800	V
I_{GT}	6 to 20	mA

Schematic Symbol

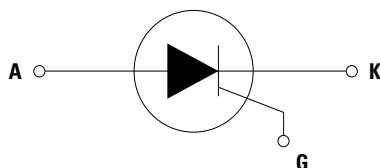

SVxx12xx series

12 Amp High Junction Temperature SCRs

Absolute Maximum Ratings

Symbol	Parameter	Test Conditions	Value	Unit
V_{DSM}/V_{RSM}	Peak non-repetitive blocking voltage	$P_W = 100 \mu s, V_{xRM} = 600 V$	$V_{DRM}/V_{RRM} + 100$	V
		$P_W = 100 \mu s, V_{xRM} = 800 V$	$V_{DRM}/V_{RRM} + 200$	
$I_{T(RMS)}$	RMS on-state current	SVxx12Lx $T_C = 110^\circ C$	12	A
		SVxx12Rx/ SVxx12Nx $T_C = 135^\circ C$		
		SVxx12D $T_C = 130^\circ C$		
$I_{T(AV)}$	Average on-state current	SVxx12Lx $T_C = 110^\circ C$	7.6	A
		SVxx12Rx/ SVxx12Nx $T_C = 135^\circ C$		
		SVxx12D $T_C = 130^\circ C$		
I_{TSM}	Peak non-repetitive surge current (single half cycle, T_J (initial) = $25^\circ C$)	SVxx12Lx/ SVxx12Rx/ SVxx12Nx f = 50Hz	100	A
		SVxx12D	120	
		SVxx12Lx/ SVxx12Rx/ SVxx12Nx f = 60Hz	120	
		SVxx12D	144	
I^2t	I^2t Value for fusing	SVxx12Lx/ SVxx12Rx/ SVxx12Nx $t_p = 8.3 ms$	60	A ² s
		SVxx12D	86	
di/dt	Critical rate of rise of on-state current	f = 60Hz; $T_J = 150^\circ C$	100	A/ μs
I_{GM}	Peak gate current	SVxx12Lx/ SVxx12Rx/ SVxx12Nx $T_J = 150^\circ C$	4	A
		SVxx12D	2	
$P_{G(AV)}$	Average gate power dissipation	SVxx12Lx/ SVxx12Rx/ SVxx12Nx $T_J = 150^\circ C$	0.8	W
		SVxx12D	0.5	
T_{stg}	Storage temperature range	–	-40 to 150	$^\circ C$
T_J	Operating junction temperature range	–	-40 to 150	$^\circ C$

Note: xx=voltage/10, x=sensitivity

Electrical Characteristics ($T_J = 25^\circ C$, unless otherwise specified)

Symbol	Test Conditions		SVxx12x1	SVxx12x2	SVxx12x	Unit
I_{GT}	$V_D = 12V, R_L = 60 \Omega$	MAX.	6	10	20	mA
		MIN.	2	5	1	
V_{GT}	$V_D = 12V, R_L = 60 \Omega$	MAX.	–	–	1.3	mA
dv/dt	$V_D = 67\% V_{DRM}$; gate open; $T_J = 125^\circ C$	MIN.	400	800	–	V/ μs
	$V_D = 67\% V_{DRM}$; gate open; $T_J = 150^\circ C$		200	400	–	
dv/dt	$V_D = V_{DRM}$; gate open; $T_J = 125^\circ C$	MIN.	–	–	200	V/ μs
	$V_D = V_{DRM}$; gate open; $T_J = 150^\circ C$		–	–	150	
V_{GD}	$V_D = V_{DRM}, R_L = 3.3 k\Omega, T_J = 150^\circ C$	MIN.	0.2	0.2	0.2	V
I_H	$I_T = 200mA$ (initial)	MAX.	22	35	40	mA
t_q	$I_T = 2A; t_p = 50\mu s; dv/dt = 5V/\mu s; di/dt = 30A/\mu s$	MAX.	25	25	35	μs
t_{gt}	$I_G = 2 \times I_{GT}, P_W = 15\mu s, I_T = 24A$	TYP.	2.6	2.6	1	μs
V_{TO}	$T_J = 150^\circ C$	MAX.	–	–	0.8	V
R_D	$T_J = 150^\circ C$	MAX.	–	–	30	m Ω

Note: xx=voltage/10, x=package

SVxx12xx series

12 Amp High Junction Temperature SCRs

Static Characteristics

Symbol	Test Conditions		Value	Unit	
V_{TM}	$I_T = 24A; t_p = 380 \mu s$		MAX.	1.6	V
I_{DRM} / I_{RRM}	$T_J = 25^\circ C$	$V_{DRM} = V_{RRM}$	MAX.	5	μA
	$T_J = 125^\circ C$	$V_{DRM} = V_{RRM} = 600V$		0.5	mA
		$V_{DRM} = V_{RRM} = 800V$		1	
	$T_J = 150^\circ C$	$V_{DRM} = V_{RRM}$		2	mA

Thermal Resistances

Symbol	Parameter		Value	Unit
$R_{\theta(jc)}$	Junction to case (AC)	SVxx12Lx	2.5	$^\circ C/W$
		SVxx12Rx/ SVxx12Nx	1.1	
		SVxx12Dx	1.5	

Note: xx=voltage/10, x=package

SVxx12xx series

12 Amp High Junction Temperature SCRs

Figure 1: Normalized DC Gate Trigger Current vs. Junction Temperature

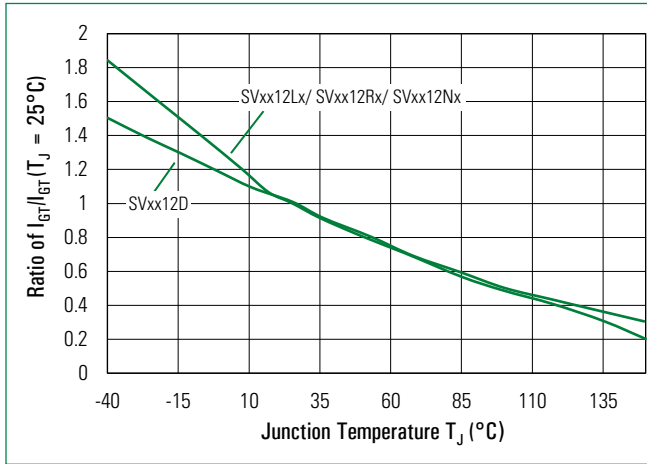

Figure 2: Normalized DC Gate Trigger Voltage vs. Junction Temperature

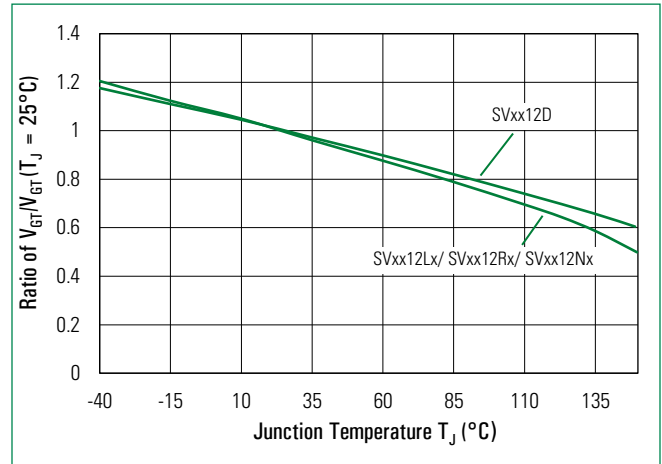

Figure 3: Normalized DC Holding Current vs. Junction Temperature

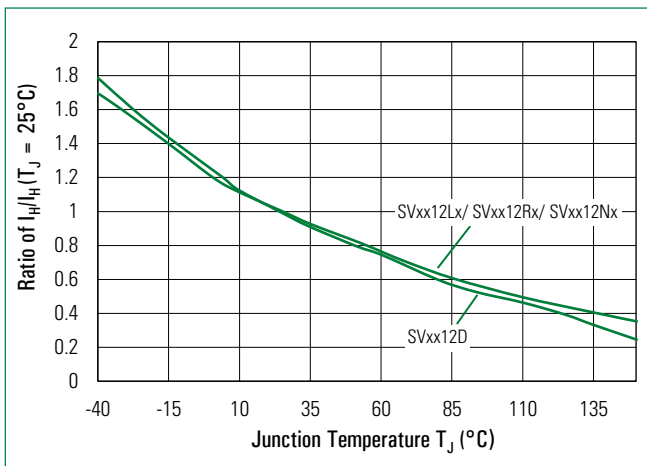

Figure 4: On-State Current vs. On-State Voltage (Typical)

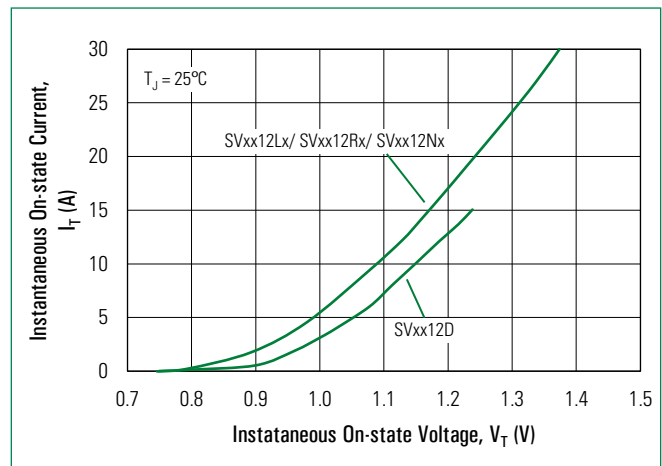

Figure 5: Power Dissipation (Typical) vs. RMS On-State Current

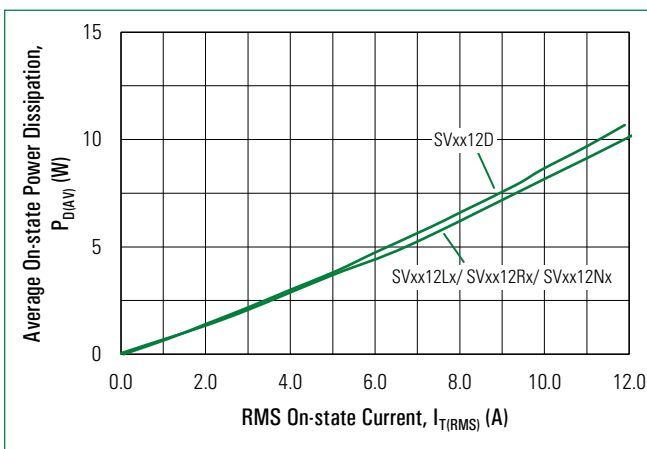
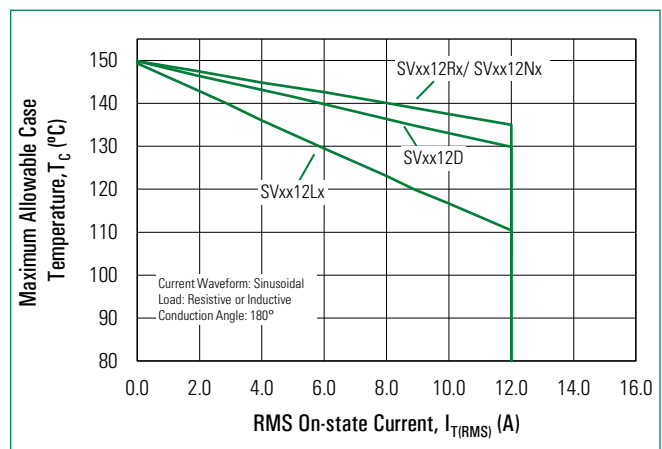

Figure 6: Maximum Allowable Case Temperature vs. RMS On-State Current



SVxx12xx series

12 Amp High Junction Temperature SCRs

Figure 7: Maximum Allowable Case Temperature vs. Average On-State Current

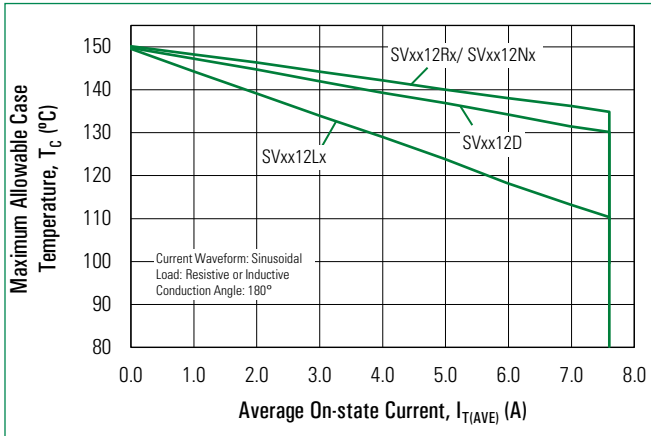

Figure 8: Peak Capacitor Discharge Current

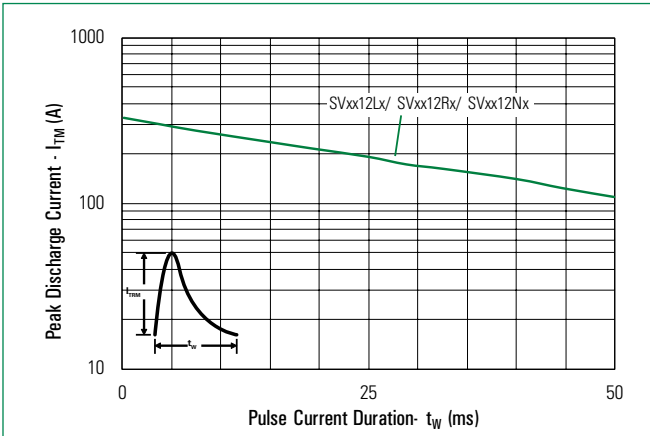

Figure 9: Peak Capacitor Discharge Current Derating

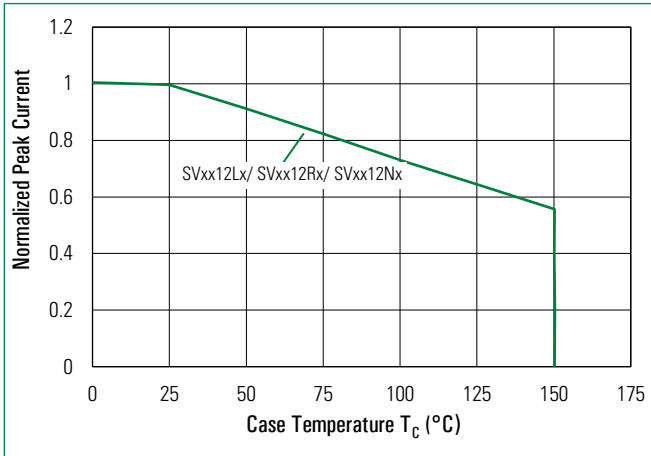
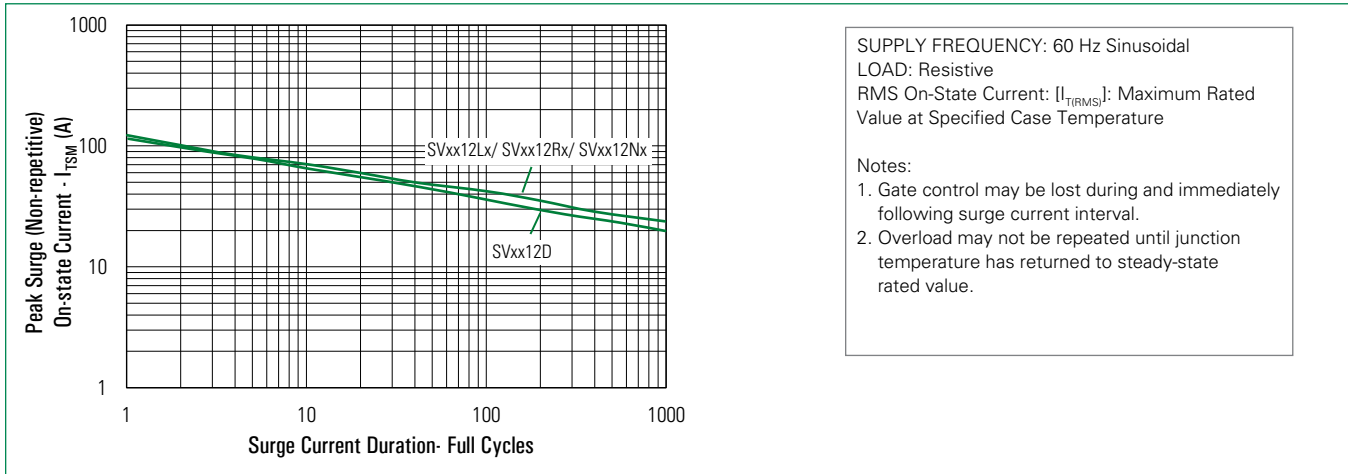

Figure 10: Surge Peak On-State Current vs. Number of Cycles



SVxx12xx series

12 Amp High Junction Temperature SCRs

Soldering Parameters

Reflow Condition		Pb – Free assembly
Pre Heat	- Temperature Min ($T_{s(min)}$)	150°C
	- Temperature Max ($T_{s(max)}$)	200°C
	- Time (min to max) (t_s)	60 – 180 secs
Average ramp up rate (Liquidus Temp) (T_L) to peak		5°C/second max
$T_{s(max)}$ to T_L - Ramp-up Rate		5°C/second max
Reflow	- Temperature (T_L) (Liquidus)	217°C
	- Time (t_l)	60 – 150 seconds
Peak Temperature (T_p)		260 ^{+0/-5} °C
Time within 5°C of actual peak Temperature (t_p)		20 – 40 seconds
Ramp-down Rate		5°C/second max
Time 25°C to peak Temperature (T_p)		8 minutes Max.
Do not exceed		280°C

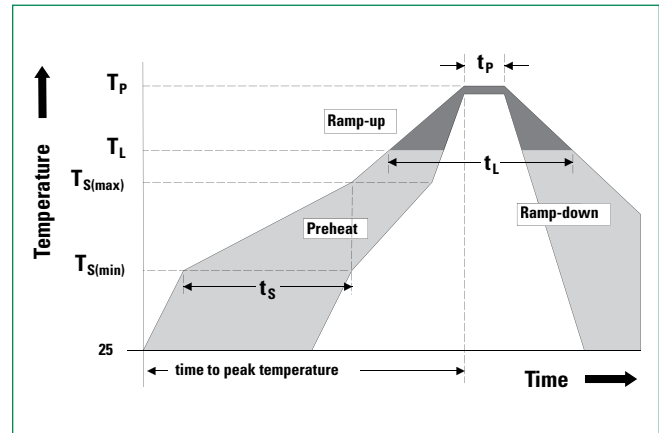

Physical Specifications

Terminal Finish	100% Matte Tin-plated
Body Material	UL Recognized compound meeting flammability rating V-0
Lead Material	Copper Alloy

Design Considerations

Careful selection of the correct component for the application's operating parameters and environment will go a long way toward extending the operating life of the Thyristor. Good design practice should limit the maximum continuous current through the main terminals to 75% of the component rating. Other ways to ensure long life for a power discrete semiconductor are proper heat sinking and selection of voltage ratings for worst case conditions. Overheating, overvoltage (including dv/dt), and surge currents are the main killers of semiconductors. Correct mounting, soldering, and forming of the leads also help protect against component damage.

Environmental Specifications

Test	Specifications and Conditions
AC Blocking	MIL-STD-750, M-1040, Cond A Applied Peak AC voltage @ 150°C for 1008 hours
Temperature Cycling	MIL-STD-750, M-1051, 1000 cycles; -55°C to +150°C; 15-min dwell-time
Temperature/Humidity	EIA / JEDEC, JESD22-A101 1008 hours; 160V - DC: 85°C; 85% rel humidity
Resistance to Solder Heat	MIL-STD-750 Method 2031
Solderability	ANSI/J-STD-002, category 3, Test A
Lead Bend	MIL-STD-750, M-2036 Cond E
Moisture Sensitivity Level	Level 1, JEDEC-J-STD-020D

SVxx12xx series

12 Amp High Junction Temperature SCRs

Dimensions – TO-220AB (L-Package) – Isolated Mounting Tab

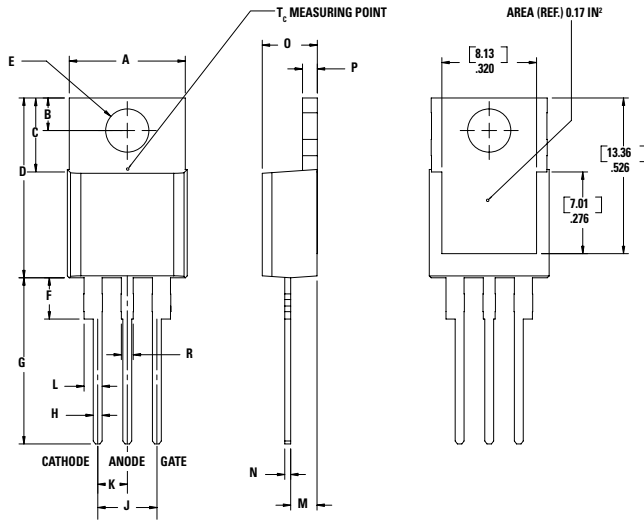

Dimension	Inches		Millimeters	
	Min	Max	Min	Max
A	0.380	0.420	9.65	10.67
B	0.105	0.115	2.67	2.92
C	0.230	0.250	5.84	6.35
D	0.590	0.620	14.99	15.75
E	0.142	0.147	3.61	3.73
F	0.110	0.130	2.79	3.30
G	0.540	0.575	13.72	14.61
H	0.025	0.035	0.64	0.89
J	0.195	0.205	4.95	5.21
K	0.095	0.105	2.41	2.67
L	0.060	0.075	1.52	1.91
M	0.085	0.095	2.16	2.41
N	0.018	0.024	0.46	0.61
O	0.178	0.188	4.52	4.78
P	0.045	0.060	1.14	1.52
R	0.038	0.048	0.97	1.22

Dimensions – TO-220AB (R-Package) – Non-Isolated Mounting Tab Common with Center Lead

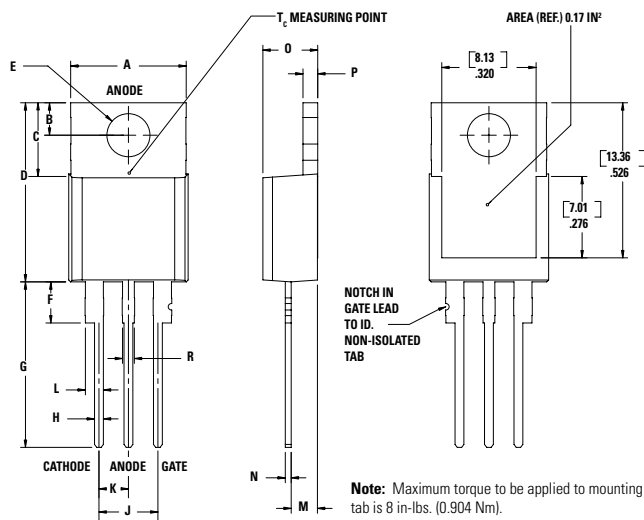

Dimension	Inches		Millimeters	
	Min	Max	Min	Max
A	0.380	0.420	9.65	10.67
B	0.105	0.115	2.67	2.92
C	0.230	0.250	5.84	6.35
D	0.590	0.620	14.99	15.75
E	0.142	0.147	3.61	3.73
F	0.110	0.130	2.79	3.30
G	0.540	0.575	13.72	14.61
H	0.025	0.035	0.64	0.89
J	0.195	0.205	4.95	5.21
K	0.095	0.105	2.41	2.67
L	0.060	0.075	1.52	1.91
M	0.085	0.095	2.16	2.41
N	0.018	0.024	0.46	0.61
O	0.178	0.188	4.52	4.78
P	0.045	0.060	1.14	1.52
R	0.038	0.048	0.97	1.22

SVxx12xx series

12 Amp High Junction Temperature SCRs

Dimensions — TO- 252AA (D-package) — D-Pak Surface Mount

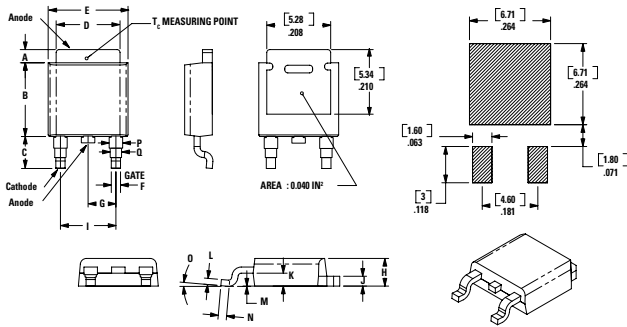

Dimension	Inches			Millimeters		
	Min	Typ	Max	Min	Typ	Max
A	0.040	0.043	0.050	1.02	1.09	1.27
B	0.235	0.243	0.245	5.97	6.16	6.22
C	0.106	0.108	0.113	2.69	2.74	2.87
D	0.205	0.208	0.213	5.21	5.29	5.41
E	0.255	0.262	0.265	6.48	6.65	6.73
F	0.027	0.031	0.033	0.69	0.80	0.84
G	0.087	0.090	0.093	2.21	2.28	2.36
H	0.085	0.092	0.095	2.16	2.33	2.41
I	0.176	0.179	0.184	4.47	4.55	4.67
J	0.018	0.020	0.023	0.46	0.51	0.58
K	0.038	0.040	0.044	0.97	1.02	1.12
L	0.018	0.020	0.023	0.46	0.51	0.58
M	0.000	0.000	0.004	0.00	0.00	0.10
N	0.021	0.026	0.027	0.53	0.67	0.69
O	0°	0°	5°	0°	0°	5°
P	0.042	0.047	0.052	1.06	1.20	1.32
Q	0.034	0.039	0.044	0.86	1.00	1.11

Dimensions — TO- 263AB (N-package) — D2-Pak Surface Mount

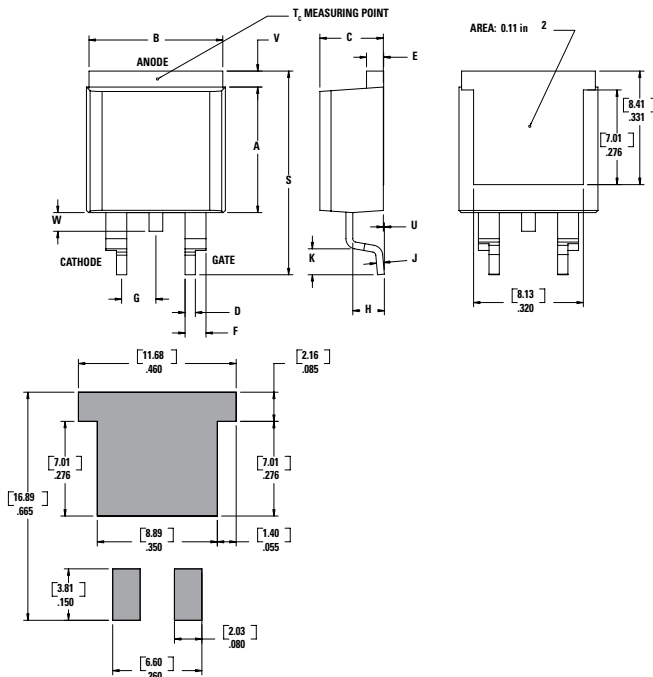

Dimension	Inches		Millimeters	
	Min	Max	Min	Max
A	0.360	0.370	9.14	9.40
B	0.380	0.420	9.65	10.67
C	0.178	0.188	4.52	4.78
D	0.025	0.035	0.64	0.89
E	0.045	0.060	1.14	1.52
F	0.060	0.075	1.52	1.91
G	0.095	0.105	2.41	2.67
H	0.092	0.102	2.34	2.59
J	0.018	0.024	0.46	0.61
K	0.090	0.110	2.29	2.79
S	0.590	0.625	14.99	15.88
V	0.035	0.045	0.89	1.14
U	0.002	0.010	0.05	0.25
W	0.040	0.070	1.02	1.78

SVxx12xx series

12 Amp High Junction Temperature SCRs

Product Selector

Part Number	Voltage		Gate Sensitivity	Type	Package
	600V	800V			
SVxx12L1	X	–	6mA	Standard SCR	TO-220L
SVxx12R1	X	–	6mA	Standard SCR	TO-220R
SVxx12N1	X	–	6mA	Standard SCR	TO-263
SVxx12L2	X	–	10mA	Standard SCR	TO-220L
SVxx12R2	X	–	10mA	Standard SCR	TO-220R
SVxx12N2	X	–	10mA	Standard SCR	TO-263
SVxx12D	–	X	20mA	Standard SCR	TO-252

Note: xx = Voltage/10

Packing Options

Part Number	Marking	Weight	Packing Mode	Base Quantity
SVxx12LxTP	SVxx12Ly	2.2g	Tube	1000 (50 per tube)
SVxx12RxTP	SVxx12Ry	2.2g	Tube	1000 (50 per tube)
SVxx12NxTP	SVxx12Ny	1.6g	Tube	1000 (50 per tube)
SVxx12NxRP	SVxx12Ny	1.6g	Embossed Carrier	500
SVxx12DTP	SVxx12D	0.3g	Tube	750 (75 per tube)
SVxx12DRP	SVxx12D	0.3g	Embossed Carrier	2500

Note: xx=voltage/10, x=sensitivity

SVxx12xx series

12 Amp High Junction Temperature SCRs

Part Numbering System

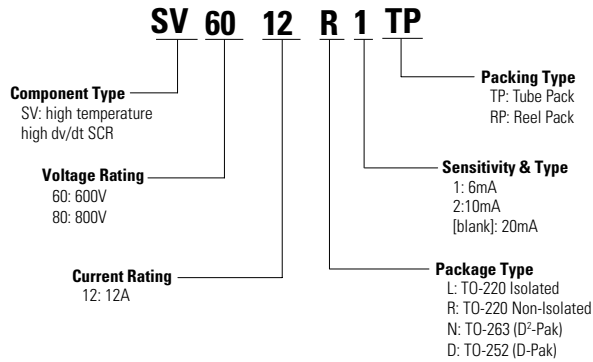

Part Marking System

TO-220 AB - (L and R Package)
TO-263 - (N Package)

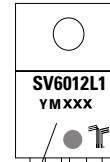

Date Code Marking
Y: Year Code
M: Month Code
XXX: Lot Trace Code

TO-252 (D-Pak)

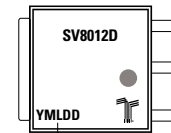

Date Code Marking
Y: Year Code
M: Month Code
L: Location Code
DD: Calendar Code

TO-263 Embossed Carrier Reel Pack (RP) Specifications

Meets all EIA-481-2 Standards

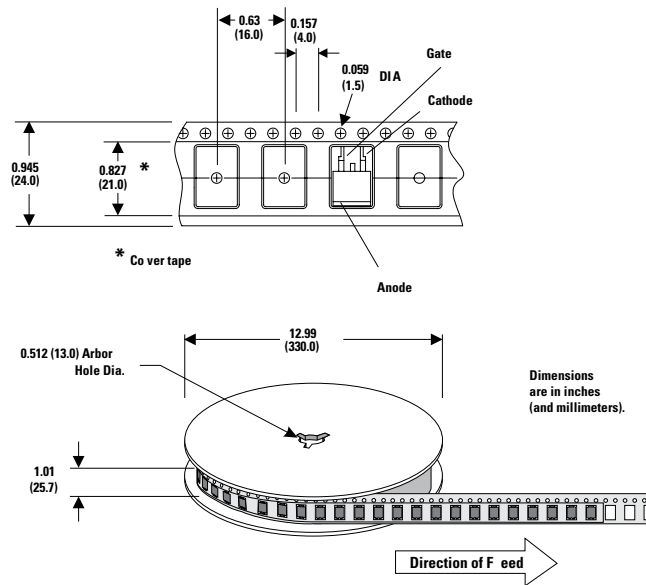

Disclaimer Notice - Information furnished is believed to be accurate and reliable. However, users should independently evaluate the suitability of and test each product selected for their own applications. Littelfuse products are not designed for, and may not be used in, all applications. Read complete Disclaimer Notice at <http://www.littelfuse.com/disclaimer-electronics>.