

Thyristor High Voltage, Phase Control SCR, 25 A

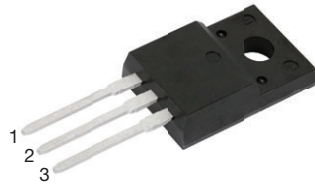

TO-220 FullPAK 3L

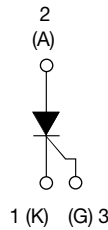

FEATURES

- Designed and qualified for industrial level
- Fully isolated package ($V_{INS} = 2500 V_{RMS}$)
- 125 °C max. operating junction temperature
- Material categorization:
for definitions of compliance please see
www.vishay.com/doc?99912



RoHS
COMPLIANT
HALOGEN
FREE

APPLICATIONS

- Typical usage is in input rectification crowbar (soft start) and AC switch in motor control, UPS, welding, and battery charge

DESCRIPTION

The VS-25TTS...FP... high voltage series of silicon controlled rectifiers are specifically designed for medium power switching and phase control applications. The glass passivation technology used has reliable operation up to 125 °C junction temperature.

PRIMARY CHARACTERISTICS

| | |
|-----------------------|-------------------|
| $I_{T(AV)}$ | 16 A |
| V_{DRM}/V_{RRM} | 800 V, 1200 V |
| V_{TM} | 1.25 V |
| I_{GT} | 45 mA |
| T_J | -40 °C to 125 °C |
| Package | 3L TO-220 FullPAK |
| Circuit configuration | Single SCR |

OUTPUT CURRENT IN TYPICAL APPLICATIONS

| APPLICATIONS | SINGLE-PHASE BRIDGE | THREE-PHASE BRIDGE | UNITS |
|--|---------------------|--------------------|-------|
| Capacitive input filter $T_A = 55$ °C, $T_J = 125$ °C, common heatsink of 1 °C/W | 18 | 22 | A |

MAJOR RATINGS AND CHARACTERISTICS

| PARAMETER | TEST CONDITIONS | VALUES | UNITS |
|-------------------|---------------------|-------------|-------|
| $I_{T(AV)}$ | Sinusoidal waveform | 16 | A |
| I_{RMS} | | 25 | |
| V_{RRM}/V_{DRM} | | 800, 1200 | V |
| I_{TSM} | | 350 | A |
| V_T | 16 A, $T_J = 25$ °C | 1.25 | V |
| dV/dt | | 500 | V/μs |
| dI/dt | | 150 | A/μs |
| T_J | | -40 to +125 | °C |

VOLTAGE RATINGS

| PART NUMBER | V_{RRM} , MAXIMUM PEAK REVERSE VOLTAGE V | V_{DRM} , MAXIMUM PEAK DIRECT VOLTAGE V | I_{RRM}/I_{DRM} AT 125 °C mA |
|-----------------|---|--|--------------------------------------|
| VS-25TTS08FP-M3 | 800 | 800 | 10 |
| VS-25TTS12FP-M3 | 1200 | 1200 | |



| ABSOLUTE MAXIMUM RATINGS | | | | | | |
|---|-----------------|---|-----------------------------------|------|---------------|----|
| PARAMETER | SYMBOL | TEST CONDITIONS | VALUES | | UNITS | |
| | | | TYP. | MAX. | | |
| Maximum average on-state current | $I_{T(AV)}$ | $T_C = 51\text{ }^\circ\text{C}$, 180° conduction half sine wave | 16 | | A | |
| Maximum RMS on-state current | I_{RMS} | | 25 | | | |
| Maximum peak, one-cycle, non-repetitive surge current | I_{TSM} | 10 ms sine pulse, rated V_{RRM} applied | 300 | | | |
| | | 10 ms sine pulse, no voltage reapplied | 350 | | | |
| Maximum I^2t for fusing | I^2t | 10 ms sine pulse, rated V_{RRM} applied | 450 | | A^2s | |
| | | 10 ms sine pulse, no voltage reapplied | 630 | | | |
| Maximum $I^2\sqrt{t}$ for fusing | $I^2\sqrt{t}$ | $t = 0.1\text{ms}$ to 10 ms, no voltage reapplied | 6300 | | $A^2\sqrt{s}$ | |
| Maximum on-state voltage drop | V_{TM} | 16 A, $T_J = 25\text{ }^\circ\text{C}$ | 1.25 | | V | |
| On-state slope resistance | r_t | $T_J = 125\text{ }^\circ\text{C}$ | 12.0 | | $m\Omega$ | |
| Threshold voltage | $V_{T(TO)}$ | | 1.0 | | V | |
| Maximum reverse and direct leakage current | I_{RM}/I_{DM} | $V_R = \text{Rated } V_{RRM}/V_{DRM}$ | $T_J = 25\text{ }^\circ\text{C}$ | 0.5 | | mA |
| | | | $T_J = 125\text{ }^\circ\text{C}$ | 10 | | |
| Holding current | I_H | Anode supply = 6 V, resistive load, initial $I_T = 1\text{ A}$, $T_J = 25\text{ }^\circ\text{C}$ | - | 150 | | |
| Maximum latching current | I_L | Anode supply = 6 V, resistive load, $T_J = 25\text{ }^\circ\text{C}$ | 200 | | | |
| Maximum rate of rise of off-state voltage | dV/dt | $T_J = T_J \text{ max.}$, linear to 80 %, $V_{DRM} = R_g - k = \text{Open}$ | 500 | | $V/\mu s$ | |
| Maximum rate of rise of turned-on current | dI/dt | | 150 | | $A/\mu s$ | |

| TRIGGERING | | | | | |
|---|-------------|---|--------|-------|----|
| PARAMETER | SYMBOL | TEST CONDITIONS | VALUES | UNITS | |
| Maximum peak gate power | P_{GM} | | 8.0 | W | |
| Maximum average gate power | $P_{G(AV)}$ | | 2.0 | | |
| Maximum peak positive gate current | + I_{GM} | | 1.5 | A | |
| Maximum peak negative gate voltage | - V_{GM} | | 10 | V | |
| Maximum required DC gate current to trigger | I_{GT} | Anode supply = 6 V, resistive load, $T_J = -10\text{ }^\circ\text{C}$ | 60 | | mA |
| | | Anode supply = 6 V, resistive load, $T_J = 25\text{ }^\circ\text{C}$ | 45 | | |
| | | Anode supply = 6 V, resistive load, $T_J = 125\text{ }^\circ\text{C}$ | 20 | | |
| Maximum required DC gate voltage to trigger | V_{GT} | Anode supply = 6 V, resistive load, $T_J = -10\text{ }^\circ\text{C}$ | 2.5 | | V |
| | | Anode supply = 6 V, resistive load, $T_J = 25\text{ }^\circ\text{C}$ | 2.0 | | |
| | | Anode supply = 6 V, resistive load, $T_J = 125\text{ }^\circ\text{C}$ | 1.0 | | |
| Maximum DC gate voltage not to trigger | V_{GD} | $T_J = 125\text{ }^\circ\text{C}$, $V_{DRM} = \text{Rated value}$ | 0.25 | | |
| Maximum DC gate current not to trigger | I_{GD} | | 2.0 | | mA |

| SWITCHING | | | | |
|-------------------------------|----------|-----------------------------------|--------|---------|
| PARAMETER | SYMBOL | TEST CONDITIONS | VALUES | UNITS |
| Typical turn-on time | t_{gt} | $T_J = 25\text{ }^\circ\text{C}$ | 0.9 | μs |
| Typical reverse recovery time | t_{rr} | $T_J = 125\text{ }^\circ\text{C}$ | 4 | |
| Typical turn-off time | t_q | | 110 | |



| THERMAL AND MECHANICAL SPECIFICATIONS | | | | |
|---|----------------|---------------------------------------|------------|------------------------|
| PARAMETER | SYMBOL | TEST CONDITIONS | VALUES | UNITS |
| Maximum junction and storage temperature range | T_J, T_{Stg} | | -40 to 125 | °C |
| Maximum thermal resistance, junction to case | R_{thJC} | DC operation | 2.5 | °C/W |
| Maximum thermal resistance, junction to ambient | R_{thJA} | | 62 | |
| Typical thermal resistance, case to heatsink | R_{thCS} | Mounting surface, smooth, and greased | 0.5 | |
| Approximate weight | | | 2 | g |
| | | | 0.07 | oz. |
| Mounting torque | minimum | | 6 (5) | kgf · cm (lbf · in) |
| | maximum | | 12 (10) | |
| Marking device | | Case style 3L TO-220 FullPAK | 25TTS08FP | |
| | | | 25TTS12FP | |

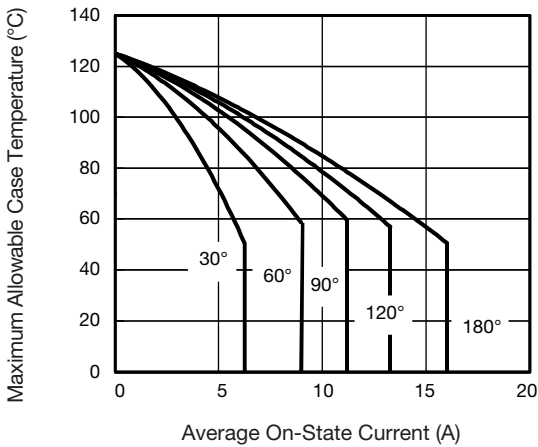

Fig. 1 - Current Rating Characteristics

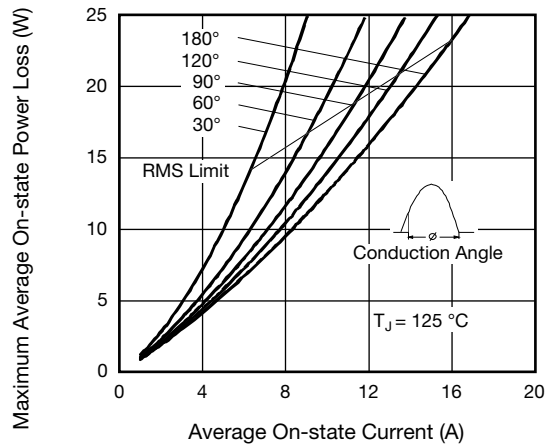

Fig. 3 - On-State Power Loss Characteristics

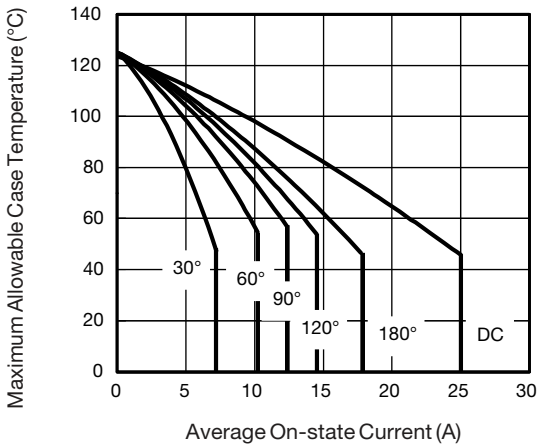

Fig. 2 - Current Rating Characteristics

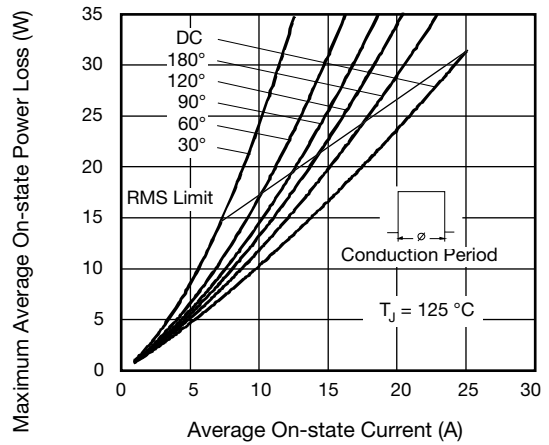

Fig. 4 - On-State Power Loss Characteristics

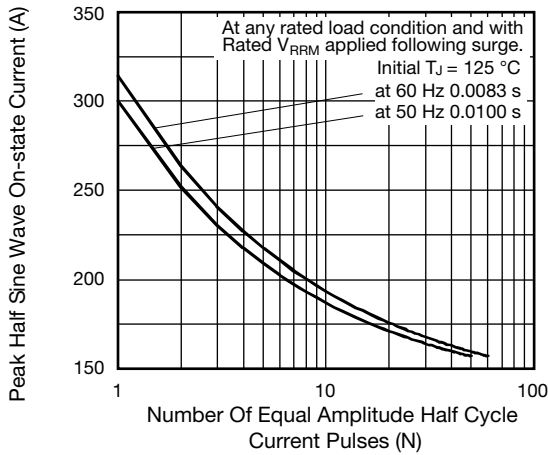

Fig. 5 - Maximum Non-Repetitive Surge Current

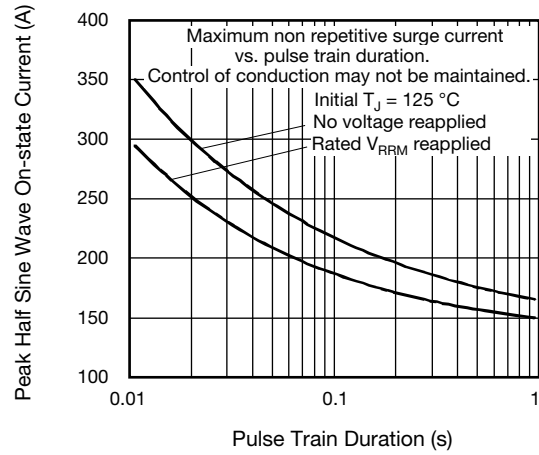

Fig. 6 - Maximum Non-Repetitive Surge Current

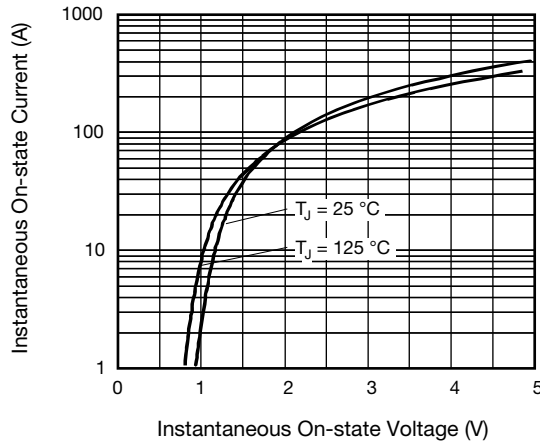

Fig. 7 - On-State Voltage Drop Characteristics

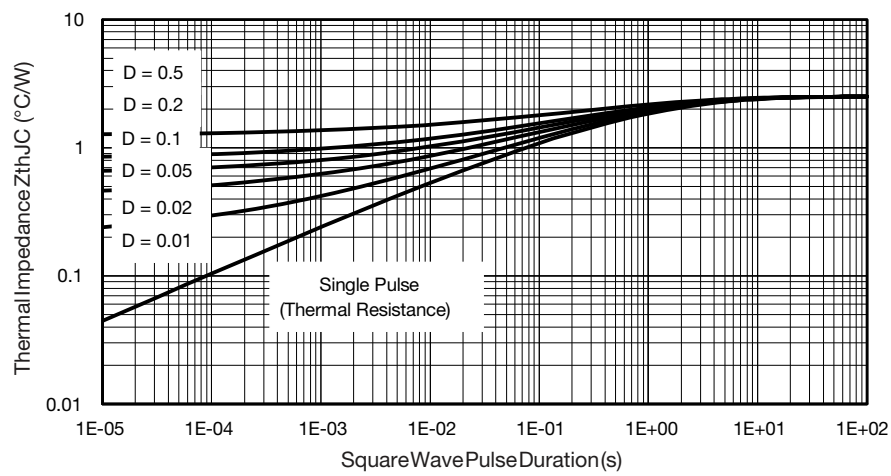

Fig. 8 - Thermal Impedance Z_{thJC} Characteristics

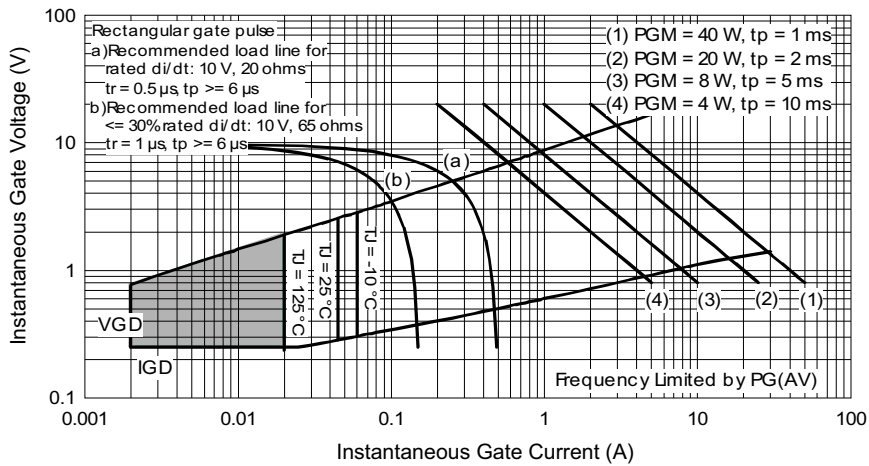

Fig. 9 - Gate Characteristics

ORDERING INFORMATION TABLE

| | | | | | | | | |
|-------------|------------|-----------|---|----------|----------|---------------------------|-----------|------------|
| Device code | VS- | 25 | T | T | S | 12 | FP | -M3 |
| | ① | ② | ③ | ④ | ⑤ | ⑥ | ⑦ | ⑧ |
| | 1 | - | Vishay Semiconductors product | | | | | |
| | 2 | - | Current rating (25 = 25 A) | | | | | |
| | 3 | - | Circuit configuration: T = single thyristor | | | | | |
| | 4 | - | Package: T = TO-220AB | | | | | |
| | 5 | - | Type of silicon: Standard recovery rectifier | | | | | |
| | 6 | - | Voltage code x 100 = V_{RRM} | | | 08 = 800 V 12 = 1200 V | | |
| | 7 | - | FullPAK | | | | | |
| | 8 | - | Environmental digit: -M3 = halogen-free, RoHS-compliant, and terminations lead (Pb)-free | | | | | |

| ORDERING INFORMATION (Example) | | | |
|---------------------------------------|------------------|------------------------|--------------------------|
| PREFERRED P/N | QUANTITY PER T/R | MINIMUM ORDER QUANTITY | PACKAGING DESCRIPTION |
| VS-25TTS08FP-M3 | 50 | 1000 | Antistatic plastic tubes |
| VS-25TTS12FP-M3 | 50 | 1000 | Antistatic plastic tubes |

| LINKS TO RELATED DOCUMENTS | |
|-----------------------------------|--|
| Dimensions | www.vishay.com/doc?96155 |
| Part marking information | www.vishay.com/doc?95456 |



3L TO-220 FullPAK

DIMENSIONS in millimeters

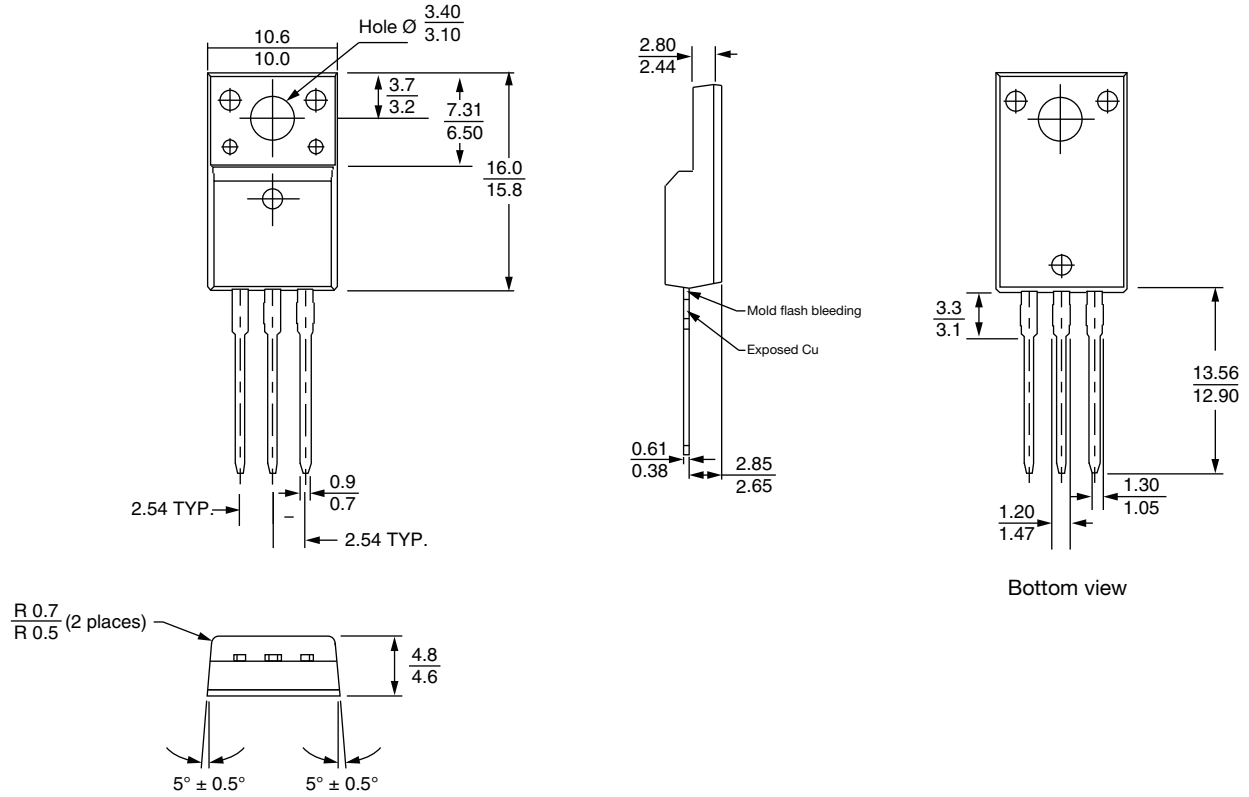

Notes

- (1) All dimensions are in mm
- (2) Package body size exclude mold flash and burrs. Moldflash should be less than 6 mils



Disclaimer

ALL PRODUCT, PRODUCT SPECIFICATIONS AND DATA ARE SUBJECT TO CHANGE WITHOUT NOTICE TO IMPROVE RELIABILITY, FUNCTION OR DESIGN OR OTHERWISE.

Vishay Intertechnology, Inc., its affiliates, agents, and employees, and all persons acting on its or their behalf (collectively, "Vishay"), disclaim any and all liability for any errors, inaccuracies or incompleteness contained in any datasheet or in any other disclosure relating to any product.

Vishay makes no warranty, representation or guarantee regarding the suitability of the products for any particular purpose or the continuing production of any product. To the maximum extent permitted by applicable law, Vishay disclaims (i) any and all liability arising out of the application or use of any product, (ii) any and all liability, including without limitation special, consequential or incidental damages, and (iii) any and all implied warranties, including warranties of fitness for particular purpose, non-infringement and merchantability.

Statements regarding the suitability of products for certain types of applications are based on Vishay's knowledge of typical requirements that are often placed on Vishay products in generic applications. Such statements are not binding statements about the suitability of products for a particular application. It is the customer's responsibility to validate that a particular product with the properties described in the product specification is suitable for use in a particular application. Parameters provided in datasheets and / or specifications may vary in different applications and performance may vary over time. All operating parameters, including typical parameters, must be validated for each customer application by the customer's technical experts. Product specifications do not expand or otherwise modify Vishay's terms and conditions of purchase, including but not limited to the warranty expressed therein.

Hyperlinks included in this datasheet may direct users to third-party websites. These links are provided as a convenience and for informational purposes only. Inclusion of these hyperlinks does not constitute an endorsement or an approval by Vishay of any of the products, services or opinions of the corporation, organization or individual associated with the third-party website. Vishay disclaims any and all liability and bears no responsibility for the accuracy, legality or content of the third-party website or for that of subsequent links.

Except as expressly indicated in writing, Vishay products are not designed for use in medical, life-saving, or life-sustaining applications or for any other application in which the failure of the Vishay product could result in personal injury or death. Customers using or selling Vishay products not expressly indicated for use in such applications do so at their own risk. Please contact authorized Vishay personnel to obtain written terms and conditions regarding products designed for such applications.

No license, express or implied, by estoppel or otherwise, to any intellectual property rights is granted by this document or by any conduct of Vishay. Product names and markings noted herein may be trademarks of their respective owners.