

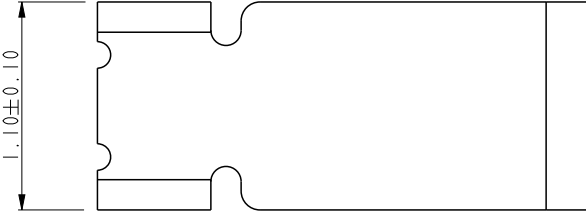

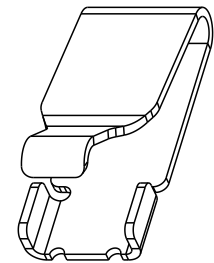

PRODUCT NO.	
FCI	10123973-004RLF
FCI	10123973-009RLF 

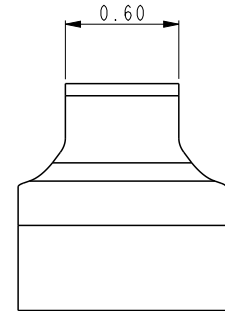
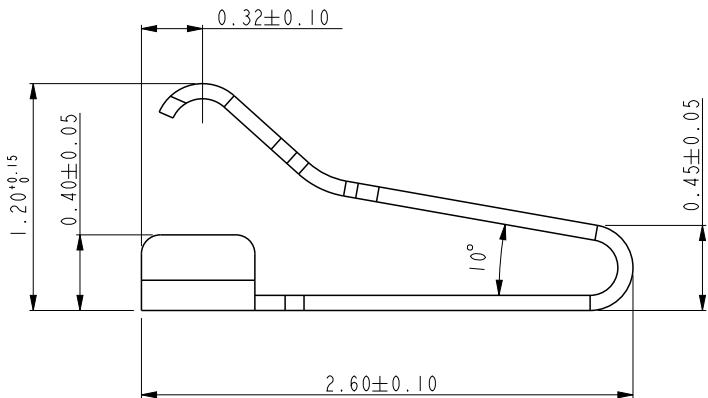

NOTES:
 1. MATERIAL: STAINLESS STEEL.
 2. CONTACT PLATING:
 CONTACT AREA: PLATING 8 MICROINCH Au OR 40 MICROINCH GXT OVER Ni UNDERPLATE, 
 SOLDER AREA : PLATING GOLD FLASH OVER Ni UNDERPLATE.
 3. PACKAGING: TAPE & REEL
 4. PART NUMBER DESCRIPTION:
 10123973-0 0 X X X

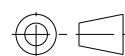
LF: LEAD FREE
 R: TAPE & REEL
 CONTACT PLATING:
 4: 8 MICROINCH Au OVER Ni
 9: 40 MICROINCH GXT OVER Ni

spec ref	*	dr	Andy Lu	2013/04/18	projection 	mm 	size	A4	scale	25 : 1
tolerance std	TOLERANCES UNLESS OTHERWISE SPECIFIED	eng	Li-Qing Lei	2019/10/18			ecn no	ELX-N-35120-1		
ASME Y14.5		chr	-	-			rel level	Released		
surface		linear	0.X	±0.3	product family	-	rel level	Released		
ASME Y14.5		angular	0°	±2°						
		appr	Tim Yao	2019/10/18	product family		-	rel level	Released	
		Amphenol FCi		title	UNIVERSAL CONTACT		dwg no	10123973		
		www.fci.com		cat. no.	Product - Customer Drw		rev	B		
						sheet 1 of 2				

Creo Title - REV E - 2016-02-12

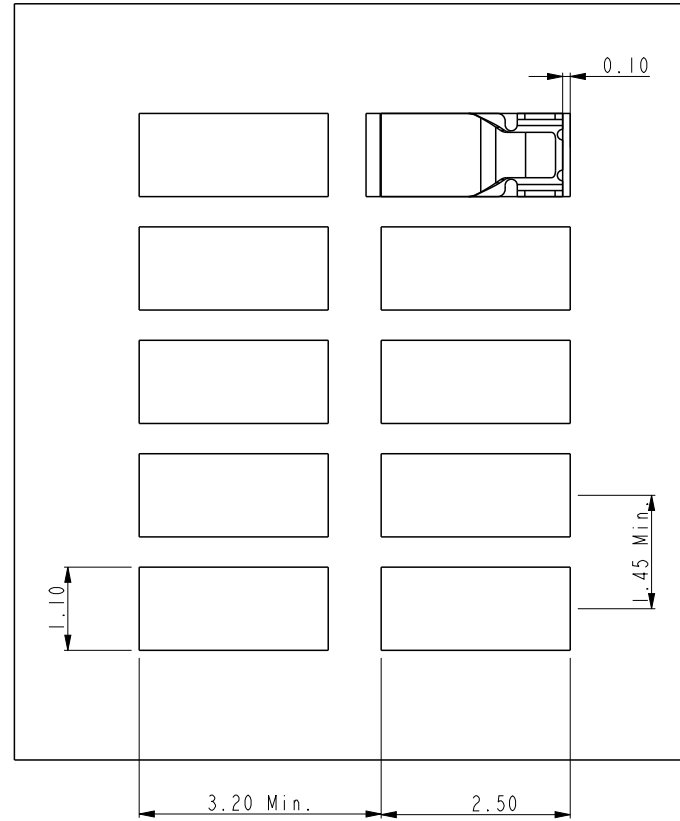

RECOMMENDED PCB DIMENSION & MIN PITCH
TOLERANCE: +/-0.05MM

spec ref *		dr	Andy Lu	2013/04/18	projection 	mm 	size	A4	scale	10 : 1				
tolerance std ASME Y14.5	TOLERANCES UNLESS OTHERWISE SPECIFIED	eng	Li-Qing Lei	2019/10/18			ecn no	ELX-N-35120-1						
		chr	-	-				rel level	Released					
		appr	Tim Yao	2019/10/18	product family		-							
surface ASME Y14.5	linear	0.X	±0.3		Amphenol FCi www.fci.com	title	UNIVERSAL CONTACT		dwg no	10123973	rev	B		
		0.XX	±0.15				cat. no.	Product - Customer Drw					sheet 2 of 2	
		0.XXX	±0.050											
	angular	0°	±2°											