

# Approval Sheet

## (產品承認書)

產品名稱	(Product)	<u>Bluetooth Low Energy Module</u>
解決方案	(Solution)	<u>Nordic nRF52832 WLCSP Package</u>
產品型號	(Model No.)	<u><b>MDBT42V – 512KV2</b> (Chip Antenna)</u> <u><b>MDBT42V – P512KV2</b> (PCB Antenna)</u>
產品料號	(Part No.)	<u>see <a href="#">4.3 Order Code</a></u>

*Advantage of MDBT42V & MDBT42V-P series:*

- Long working distance:*  
**MDBT42V:** over 80 meters in open space.  
**MDBT42V-P:** up to 60 meters in open space.
- Declaration ID includes all Nordic applied profiles.*
- Granted main regional certification such as FCC (USA), CE(EU)  
TELEC (Japan), SRRC (China), IC (Canada), NCC (Taiwan) and KC (South Korea).*

# Index

<b>1. Overall Introduction</b>	<b>4</b>
1.1. Applications	4
1.2. Features	5
<b>2. Product Dimension</b>	<b>6</b>
2.1. PCB Dimensions & Pin Indication	6
2.2. Recommended Layout of Solder Pad	8
2.3. RF Layout Suggestion (aka Keep-Out Area)	10
2.4. Footprint & Design Guide	12
2.5. Pin Assignment	13
2.6. GPIO Located Near the Radio	15
<b>3. Main Chip Solution</b>	<b>15</b>
<b>4. Shipment Packaging Information</b>	<b>16</b>
4.1. Marking on Metal Shield	17
4.2. Packaging Info	18
4.3. Order Code	20
<b>5. Specification</b>	<b>21</b>
5.1. Absolute Maximum Ratings	21
5.2. Operation Conditions	21
5.3. Electrical Specifications	22
<b>6. Block Diagram</b>	<b>27</b>
<b>7. Antenna</b>	<b>28</b>
7.1. MDBT42V	28
7.2. MDBT42V-P	29
<b>8. Reference Circuit</b>	<b>30</b>
<b>9. Certification</b>	<b>31</b>
9.1. Declaration ID	31
9.2. FCC Certificate (USA)	33
9.3. TELEC Certificate (Japan)	34
9.4. NCC Certificate (Taiwan)	35
9.5. CE Test Report (EU)	37
9.6. IC Certificate (Canada)	39
9.7. SRRC Certificate (China)	40

9.8. KC Certificate (South Korea) .....	41
9.9. RoHS & REACH Report .....	42
9.10. End-Product Label .....	42
<b>10. Notes and Cautions.....</b>	<b>44</b>
<b>11. Basic Facts for nRF52 Chip.....</b>	<b>45</b>
<b>12. Useful Links .....</b>	<b>46</b>
<b>Full List of Raytac's BLE Modules .....</b>	<b>47</b>
<b>Release Note.....</b>	<b>51</b>

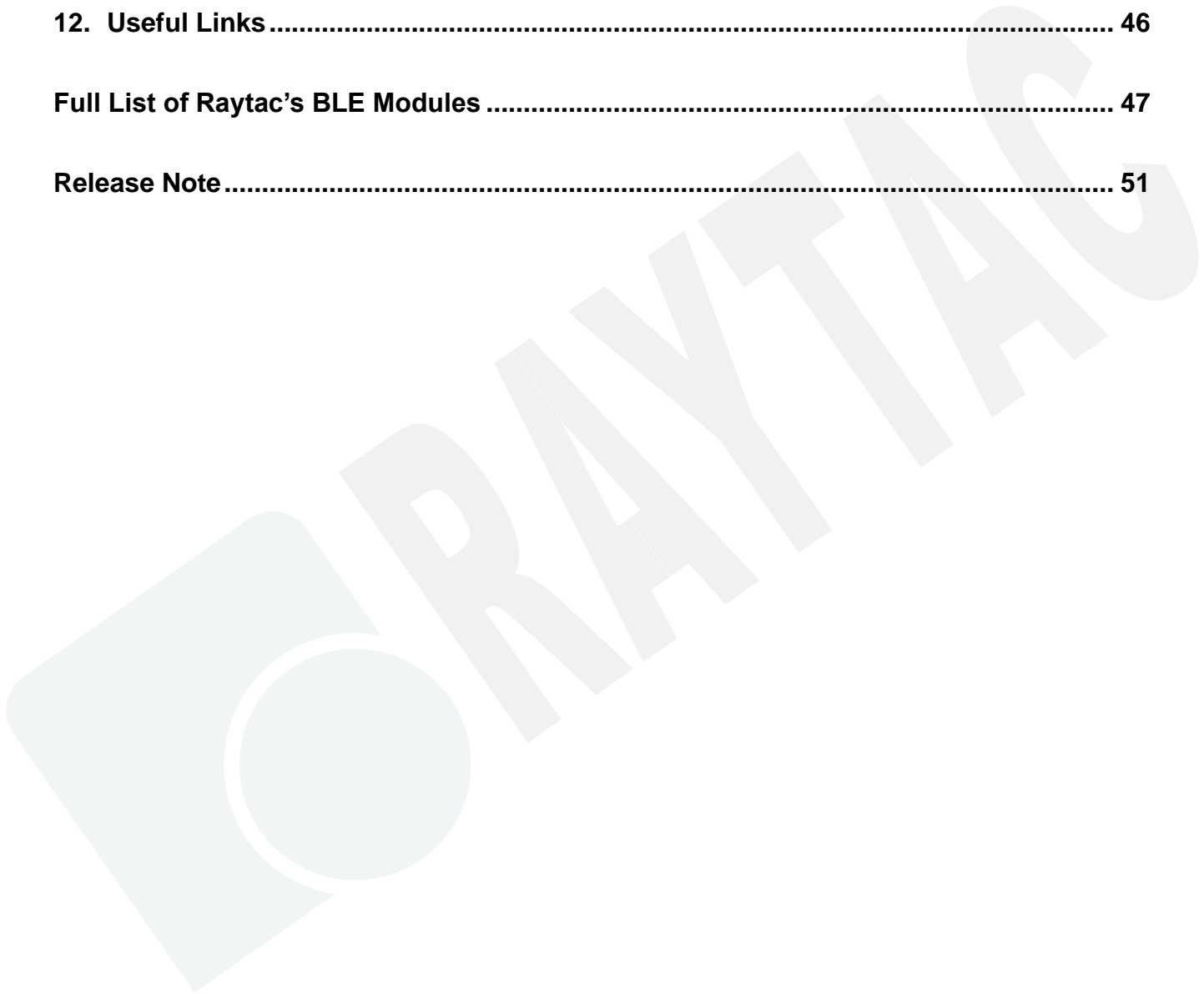

# 1. Overall Introduction

Raytac's MDBT42V & MDBT42V-P is a BT 5.2 stack (Bluetooth low energy or BLE) module designed based on **Nordic nRF52832 SoC solution**, which incorporates: **GPIO, SPI, UART, I2C, I2S, PWM, ADC** and **NFC** interfaces for connecting peripherals and sensors.

Features:

1. Dual Transmission mode of BLE & 2.4Ghz RF upon customer preference.
2. Compact size with **(L) 8.4 x (W) 6.4 x (H) 1.75 or 1.50 mm**.
3. Low power requirements, ultra-low peak, average and idle mode power consumption.
4. Be compatible with a large installed base of mobile phones, tablets and computers.
5. Fully coverage of BLE software stack.
6. BLE & RF transmission switching helps products fit all operation system and most hardware.

## 1.1. Applications

- IoT
  - Home automation
  - Sensor networks
  - Building automation
- Personal Area Networks
  - Health / fitness sensor and monitor device
  - Medical devices
  - Key-fobs and wrist watches
- Interactive entertainment devices
  - Remote control
  - Gaming controller
- Beacons
- A4WP wireless chargers and devices
- Remote control toys
- Computer peripherals and I/O devices
  - Mouse
  - Keyboard
  - Multi-touch trackpad

## 1.2. Features

- Multi-protocol 2.4GHz radio
- ARM® Cortex®-M4 32-bit processor with FPU, 64 MHz
- 512KB flash programmed memory and 64KB RAM
- Software stacks available as downloads
- Application development independent from protocol stack
- On-air compatible with nRF51, nRF24AP and nRF24L series
- Programmable TX output power from -20dBm to +4dBm in 4dB steps
- RSSI
- RAM mapped FIFOs using EasyDMA
- Dynamic on-air payload length up to 256 bytes
- Flexible and configurable 20 pin GPIO
- Programmable peripheral interface - PPI
- Simple ON / OFF global power mode
- Full set of digital interface all with Easy DMA including:
  - 3 x Hardware SPI master ; 3 x Hardware SPI slave
  - 2 x two-wire master ; 2 x two-wire slave
  - 1 x UART (CTS / RTS)
  - PDM for digital microphone
  - I2S for audio
- Quadrature demodulator
- 12-bit / 200KSPS ADC
- 128-bit AES ECB / CCM / AAR co-processor
- Low cost external crystal 32MHz  $\pm$  40ppm for Bluetooth ;  $\pm$  50ppm for ANT Plus
- Low power 32MHz crystal and RC oscillators
- Wide supply voltage range 1.7V to 3.6V
- On-chip DC/DC buck converter
- Individual power management for all peripherals
- Timer counter
  - 5 x 32-bit
  - 3 x 24-bit RTC
- Type 2 near field communication (NFC-A) tag with wakeup-on-field and touch-to-pair capabilities
- 3x 4-channel pulse width modulator (PWM) units with EasyDMA

## 2. Product Dimension

### 2.1. PCB Dimensions & Pin Indication

#### • MDBT42V-512KV2

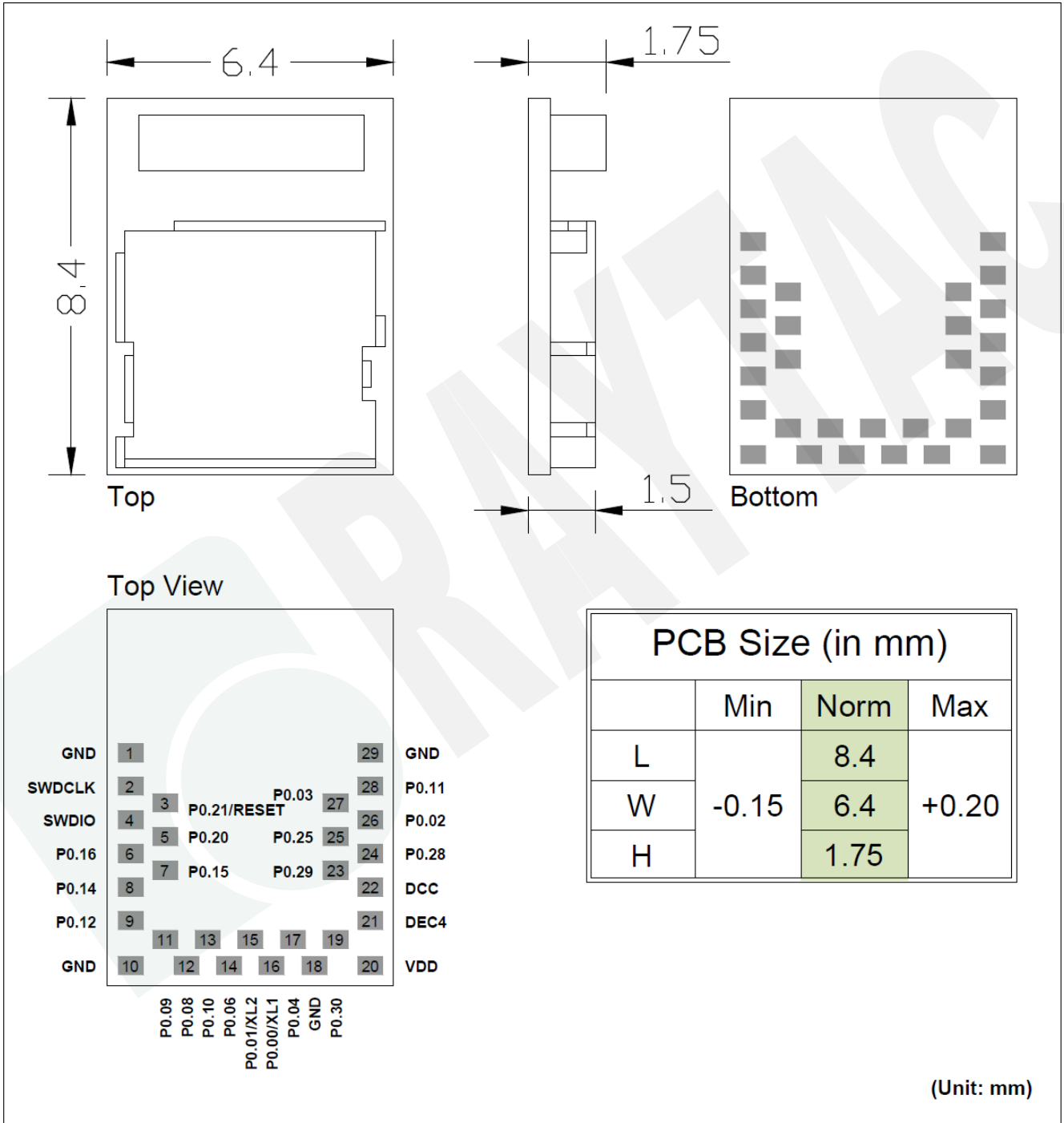

• **MDBT42V-P512KV2**

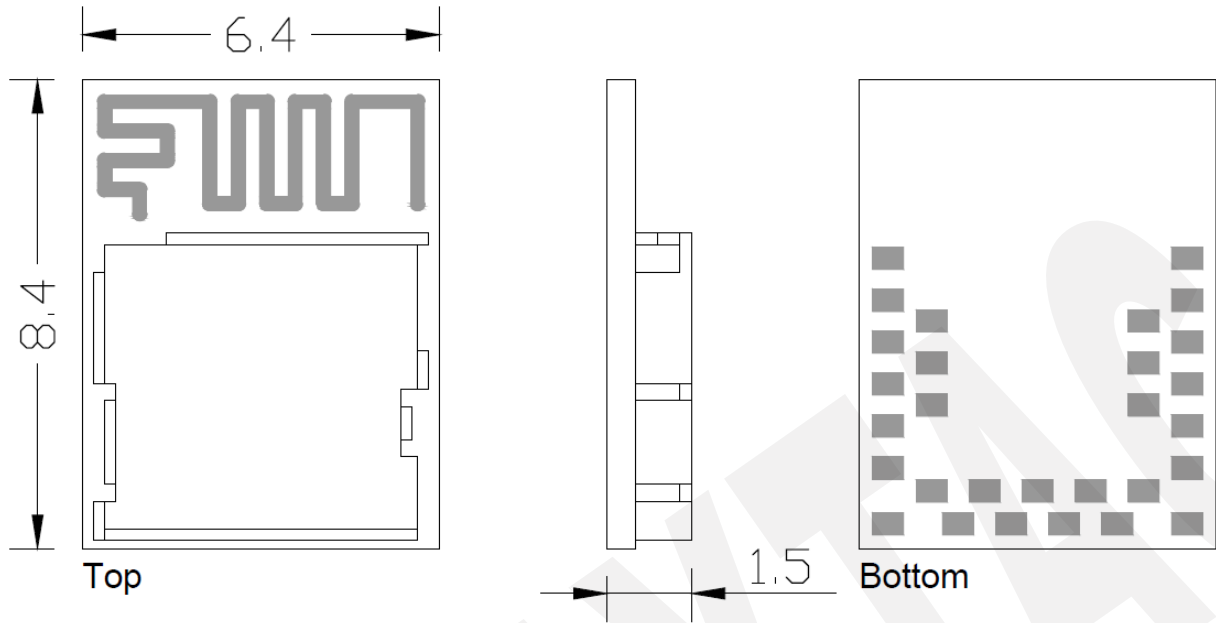

Top View

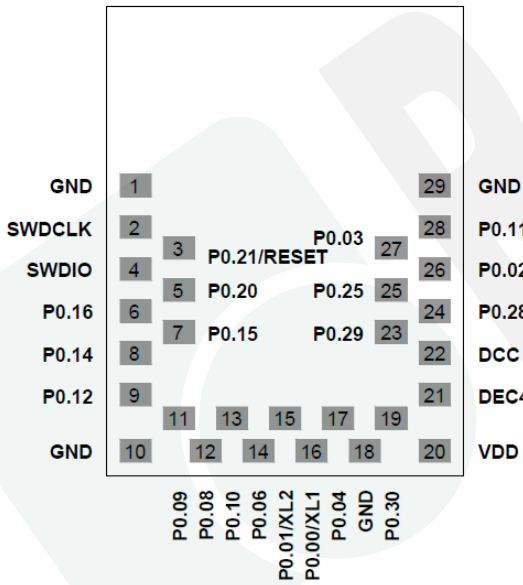



PCB Size (in mm)			
	Min	Norm	Max
L		8.4	
W	-0.15	6.4	+0.20
H		1.50	

(Unit: mm)

## 2.2. Recommended Layout of Solder Pad

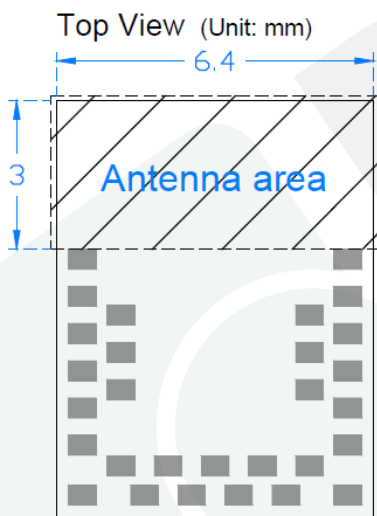
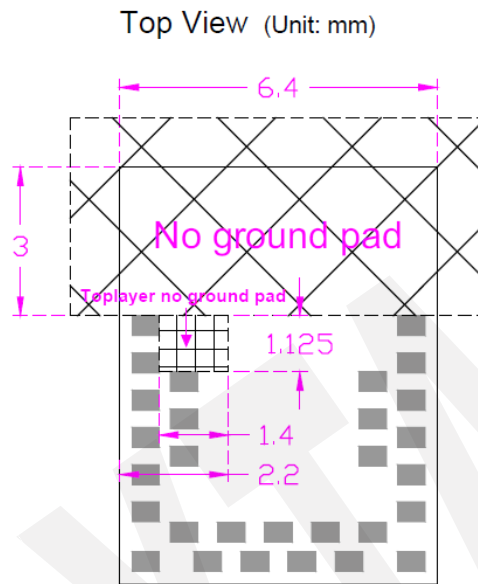
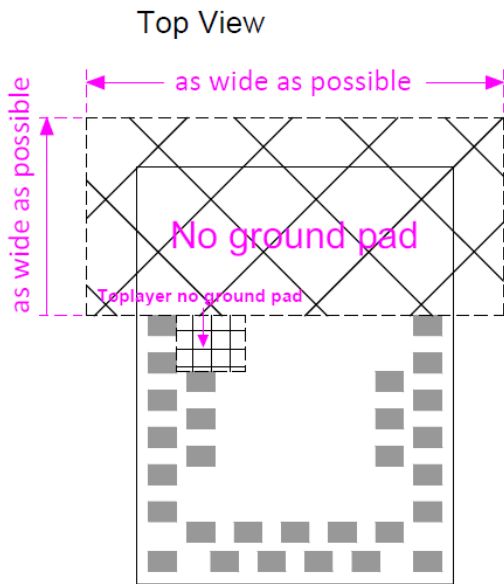
*Graphs are all in Top View, Unit in mm.*



 Antenna area

 No ground pad (as wide as possible)

 Toplayer no ground pad



Top View (Unit: mm)

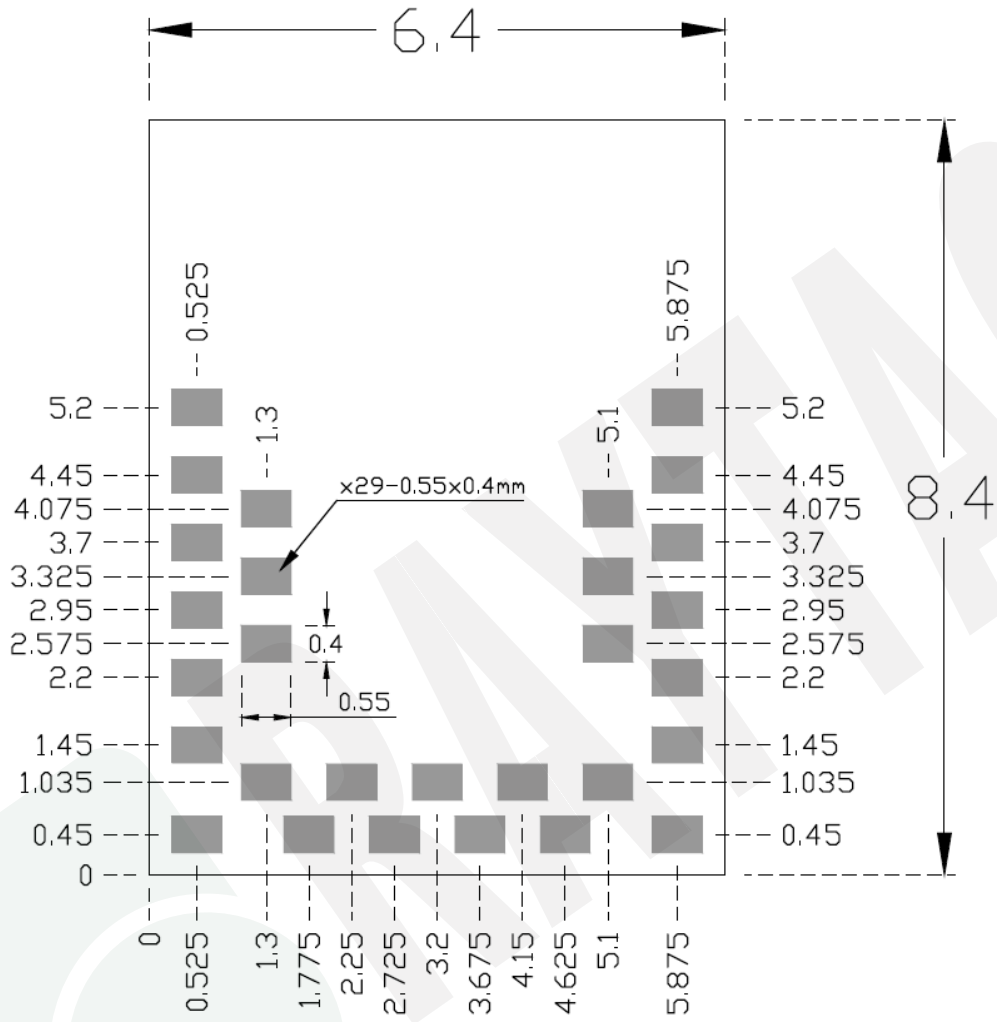

## 2.3. RF Layout Suggestion (aka Keep-Out Area)

Make sure to keep the “No Ground Pad” as wider as you can regardless of the size of your PCB.

No-Ground Pad should be included in the corresponding position of the antenna in **EACH LAYER**.

Place the module towards the edge of PCB to have better performance than placing it on the center.

Welcome to send us your layout in PDF for review at [service@raytac.com](mailto:service@raytac.com) or your contact at Raytac with title “Layout reviewing – Raytac model no. – YOUR company’s name”.

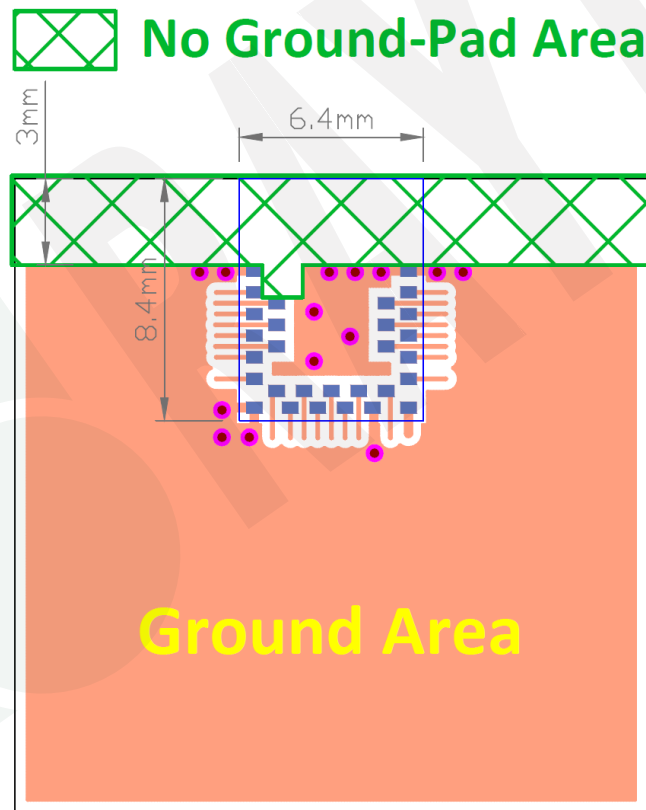

**Top View**

Please add via holes in GROUND area as many as possible, especially around the four corners.

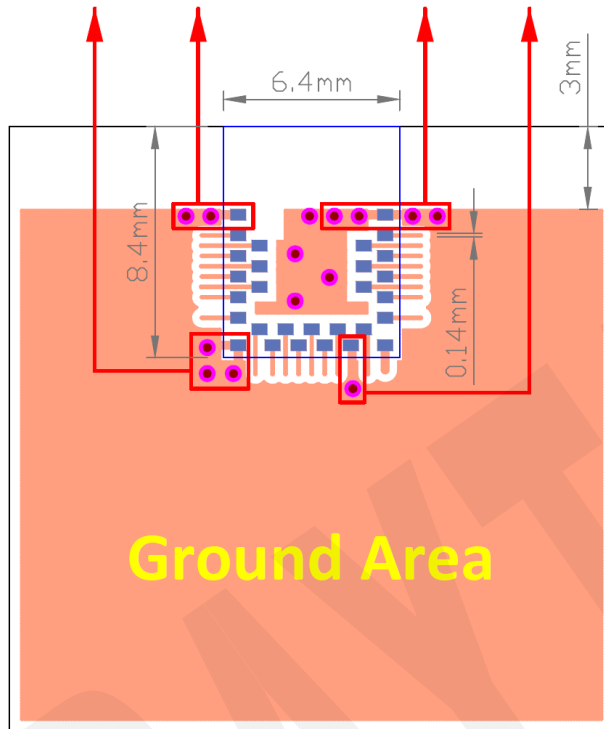

**Top View**

 No Ground-Pad Area

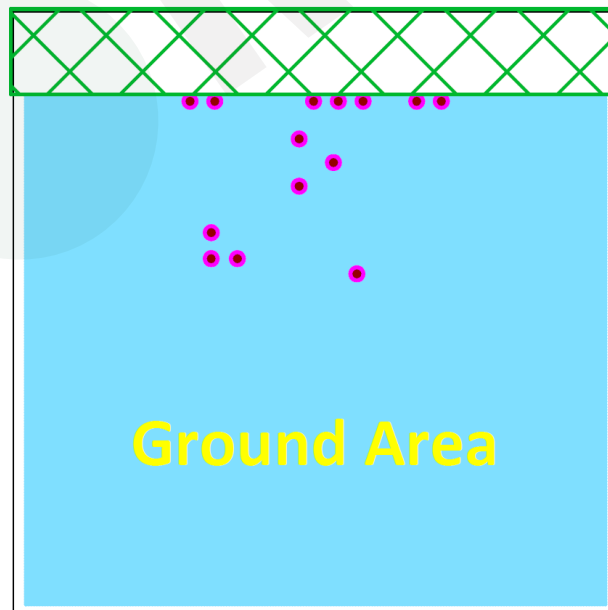

**Perspective View**

## Examples of “NOT RECOMMENDED” layout

 where should be NO-GROUND area

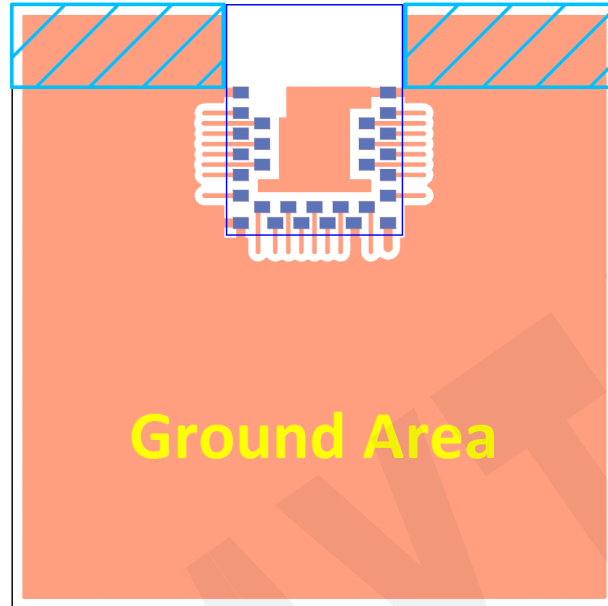

 where should be NO-GROUND area

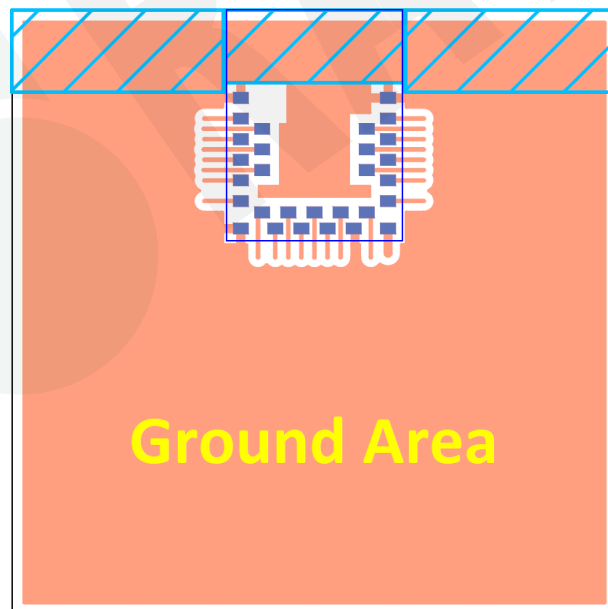

## 2.4. Footprint & Design Guide

Please visit “[Support](#)” page of our website to download. The package includes footprint, 2D/3D drawing, reflow graph and recommended spec for external 32.768khz.

## 2.5. Pin Assignment

Pin No.	Name	Pin function	Description
(1)	<b>GND</b>	Ground	The pad must be connected to a solid ground plane
(2)	<b>SWCLK</b>	Digital input	Serial Wire debug clock input for debug and programming
(3)	<b>P0.21</b>	Digital I/O	General-purpose digital I/O
	<b>RESET</b>		Configurable as system RESET pin
(4)	<b>SWDIO</b>	Digital I/O	Serial Wire debug I/O for debug and programming
(5)	<b>P0.20</b>	Digital I/O	General-purpose digital I/O
	<b>TraceCLK</b>		Trace port clock output
(6)	<b>P0.16</b>	Digital I/O	General-purpose digital I/O
	<b>TraceData(1)</b>		Trace port output
(7)	<b>P0.15</b>	Digital I/O	General-purpose digital I/O
	<b>TraceData(2)</b>		Trace port output
(8)	<b>P0.14</b>	Digital I/O	General-purpose digital I/O
	<b>TraceData(3)</b>		Trace port output
(9)	<b>P0.12</b>	Digital I/O	General-purpose digital I/O
(10)	<b>GND</b>	Ground	The pad must be connected to a solid ground plane
(11)	<b>P0.09</b>	Digital I/O	General-purpose digital I/O
	<b>NFC1</b>	NFC input	NFC antenna connection
(12)	<b>P0.08</b>	Digital I/O	General-purpose digital I/O
(13)	<b>P0.10</b>	Digital I/O	General-purpose digital I/O
	<b>NFC2</b>	NFC input	NFC antenna connection
(14)	<b>P0.06</b>	Digital I/O	General-purpose digital I/O
(15)	<b>P0.01</b>	Digital I/O	General-purpose digital I/O
	<b>XL2</b>	Analog input	Connection to 32.768khz crystal (LFXO)
(16)	<b>P0.00</b>	Digital I/O	General-purpose digital I/O
	<b>XL1</b>	Analog input	Connection to 32.768khz crystal (LFXO)
(17)	<b>P0.04</b>	Digital I/O	General-purpose digital I/O
	<b>AIN2</b>	Analog input	SAADC/COMP/LPCOMP input
(18)	<b>GND</b>	Ground	The pad must be connected to a solid ground plane
(19)	<b>P0.30</b>	Digital I/O	General-purpose digital I/O
	<b>AIN6</b>	Analog input	SAADC/COMP/LPCOMP input

Pin No.	Name	Pin function	Description
(20)	VDD	Power	Power-supply pin
(21)	DEC4	Power	1V3 regulator supply decoupling.
(22)	DCC	Power	DC/DC converter output pin
(23)	P0.29	Digital I/O	General-purpose digital I/O
	AIN5	Analog input	SAADC/COMP/LPCOMP input
(24)	P0.28	Digital I/O	General-purpose digital I/O
	AIN4	Analog input	SAADC/COMP/LPCOMP input
(25)	P0.25	Digital I/O	General-purpose digital I/O
(26)	P0.02	Digital I/O	General-purpose digital I/O
	AIN0	Analog input	SAADC/COMP/LPCOMP input
(27)	P0.03	Digital I/O	General-purpose digital I/O
	AIN1	Analog input	SAADC/COMP/LPCOMP input
(28)	P0.11	Digital I/O	General-purpose digital I/O
(29)	GND	Ground	The pad must be connected to a solid ground plane

## 2.6. GPIO Located Near the Radio

Some GPIO have recommended usage. To maximize RF performance, these GPIO are only available to use as **low drive, low frequency I/O only**. Wrong usage may lead to undesirable performance. Here is the list of these GPIO.

*Low frequency I/O is a signal with a frequency up to 10 kHz. SPI, I2C, UART, PWM are NOT low frequency I/O.*



Module Pin	GPIO
25	P0.25
24	P0.28
23	P0.29
19	P0.30

## 3. Main Chip Solution

RF IC	Crystal Frequency
Nordic NRF52832	32MHZ

*32MHz crystal is already inside the module.*

## 4. Shipment Packaging Information

Model	Antenna	Photo
MDBT42V-512KV2	Chip/Ceramic	
MDBT42V-P512KV2	PCB/Printed	

- Unit Weight of Module:

MDBT42V-512KV2: 0.17g ( $\pm 0.02$ g) ; MDBT42V-P512KV2: 0.15g ( $\pm 0.02$ g)

- Packaging Type: Anti-static tray or Tape & Reel.

	Tray	Tape & Reel (13")	Tape & Reel (7")
<b>MPQ (Min. Package Q'ty)</b>	160 pcs per tray	1,760 pcs per reel	640 pcs per reel
<b>Carton Contents (per carton)</b>	3,200 pcs	1,760 pcs	640 pcs
<b>Carton Dimension (L) x (W) x (H) cm</b>	37 x 21 x 13	37 x 36 x 6	37 x 36 x 6
<b>Gross Weight</b>	about 2.2 kgs	about 1.2 kgs	about 1 kg



## 4.1. Marking on Metal Shield

### 4.1.1. Label



Label contexts for date code 101 (starts from year 2021) and later.

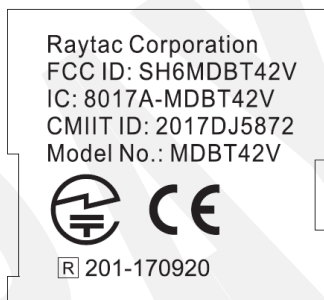

For date code before 101.

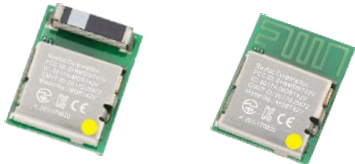

### 4.1.2. Dot Marking

Dot	Date Code	IC Revision	Photo
Yellow	813 ~ 946	2	
None	001 and later (starts from 2020)	2	

## 4.2. Packaging Info

### 4.2.1. Tray Packaging

Anti-Static tray is specifically designed for mass production. It can be used directly on SMT automatic machine.

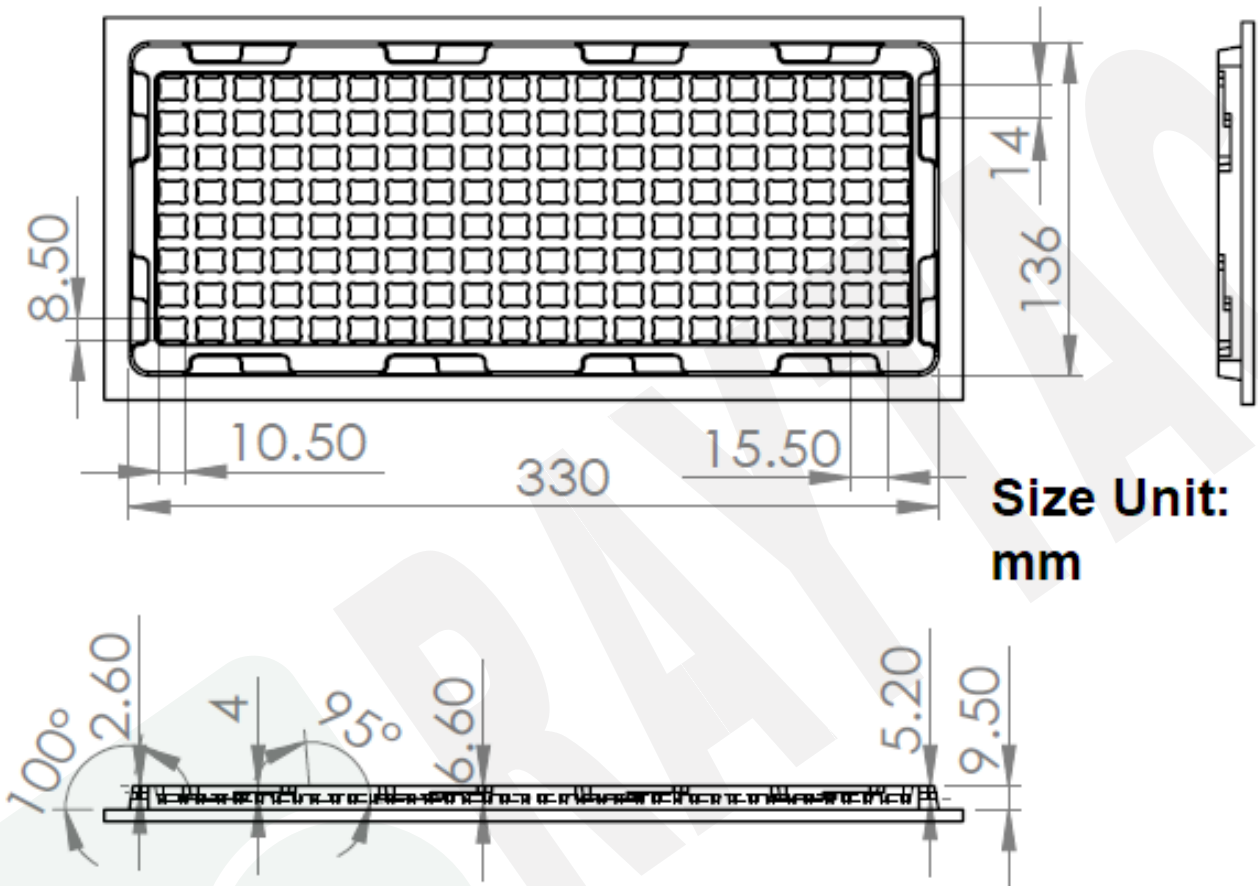

## 4.2.2. Tape & Reel Packaging

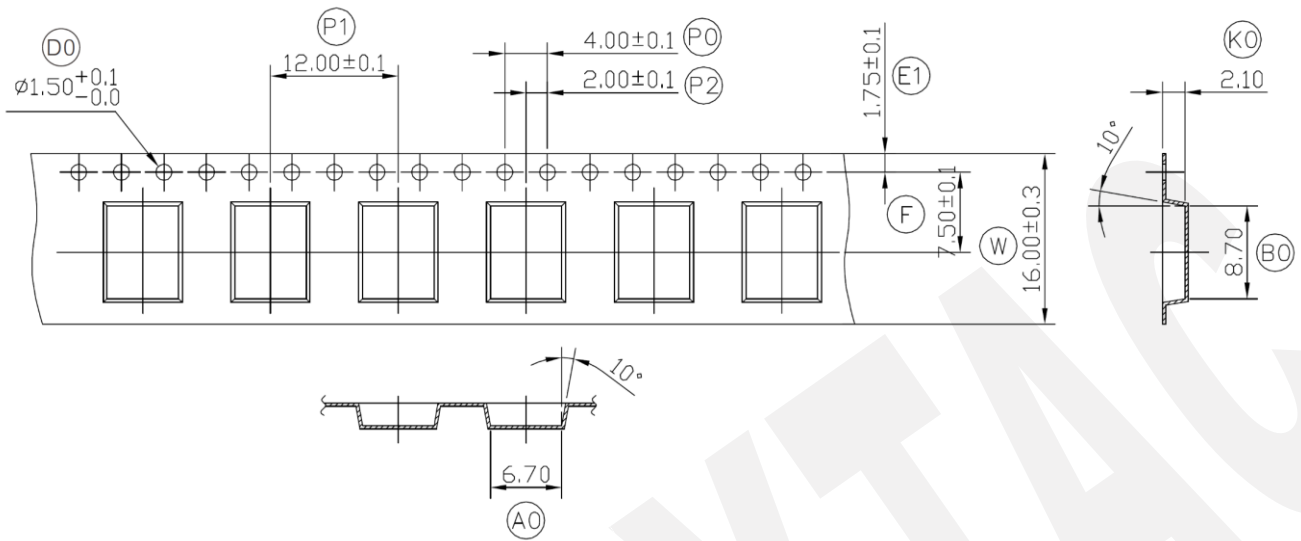

W	<b>16.00</b>	±0.30
P1	<b>12.00</b>	±0.10
E1	1.75	±0.10
F	<b>7.50 ± 0.10</b>	
D0	1.50	+0.1/-0
P0	4.00	±0.10
P2	2.00 ± 0.10	
A0	<b>6.70</b>	±0.10
B0	<b>8.70</b>	±0.10
K0	<b>2.10</b>	±0.10
T	0.30	±0.05

### 4.3. Order Code

Each model has two options of packaging. Please use following part no. when placing order to us.

Model	Tray	Tape & Reel
MDBT42V-512KV2	MD-240A2-S29	(13") MD-240A2-S29R
		(7") MD-240A2-S29R7
MDBT42V-P512KV2	MD-240A2-S30	(13") MD-240A2-S30R
		(7") MD-240A2-S30R7

	Tray	Tape & Reel (13")	Tape & Reel (7")
<b>MPQ (Min. Package Q'ty)</b>	160 pcs per tray	1,760 pcs per reel	640 pcs per reel
<b>Carton Contents (per carton)</b>	3,200 pcs	1,760 pcs	640 pcs
<b>Carton Dimension (L) x (W) x (H) cm</b>	37 x 21 x 13	37 x 36 x 6	37 x 36 x 6
<b>Gross Weight</b>	about 2.2 kgs	about 1.2 kgs	about 1 kg

## 5. Specification

Any technical spec shall refer to Nordic's official documents as final reference. Contents below are from "[nRF52832 Product Specification v1.8](#)", please click to download full spec.

### 5.1. Absolute Maximum Ratings

	Min.	Max.	Unit
<b>Supply voltages</b>			
VDD	-0.3	+3.9	V
VSS		0	V
<b>I/O pin voltage</b>			
$V_{I/O}, VDD \leq 3.6 \text{ V}$	-0.3	$VDD + 0.3 \text{ V}$	V
$V_{I/O}, VDD > 3.6 \text{ V}$	-0.3	3.9 V	V
<b>NFC antenna pin current</b>			
$I_{NFC1/2}$		80	mA
<b>Radio</b>			
RF input level		10	dBm
<b>Flash memory</b>			
Endurance	10 000		Write/erase cycles
Retention	10 years at 40°C		
<b>Environmental WLCSP, 3.0×3.2 mm package</b>			
Storage temperature	-40	+125	°C
MSL		1	
ESD HBM (human body model)		2	kV
ESD CDM (charged device model)		500	V

### 5.2. Operation Conditions

Symbol	Parameter	Min.	Nom.	Max.	Units
VDD	Supply voltage, independent of DCDC enable	1.7	3.0	3.6	V
$t_{R\_VDD}$	Supply rise time (0 V to 1.7 V)			60	ms
TA	Operating temperature	-40	25	85	°C

**Important:** The on-chip power-on set circuitry may not function properly for rise times longer than the specified maximum.

## 5.3. Electrical Specifications

### 5.3.1. General Radio Characteristics

Symbol	Description	Min.	Typ.	Max.	Units
$f_{OP}$	Operating frequencies	2360		2500	MHz
$f_{PLL,PROG,RES}$	PLL programming resolution		2		kHz
$f_{PLL,CH,SP}$	PLL channel spacing		1		MHz
$f_{DELTA,1M}$	Frequency deviation @ 1 Msps		$\pm 170$		kHz
$f_{DELTA,BLE,1M}$	Frequency deviation @ BLE 1Msps		$\pm 250$		kHz
$f_{DELTA,2M}$	Frequency deviation @ 2 Msps		$\pm 320$		kHz
$f_{DELTA,BLE,2M}$	Frequency deviation @ BLE 2 Msps		$\pm 500$		kHz
$f_{skSps}$	On-the-air data rate	1		2	Msps

### 5.3.2. Radio Current Consumption (Transmitter)

Symbol	Description	Min.	Typ.	Max.	Units
$I_{TX,PLUS4dBm,DCDC}$	TX only run current (DCDC, 3V) $P_{RF} = +4$ dBm		7.5		mA
$I_{TX,PLUS4dBm}$	TX only run current $P_{RF} = +4$ dBm		16.6		mA
$I_{TX,0dBm,DCDC}$	TX only run current (DCDC, 3V) $P_{RF} = 0$ dBm		5.3		mA
$I_{TX,0dBm}$	TX only run current $P_{RF} = 0$ dBm		11.6		mA
$I_{TX,MINUS4dBm,DCDC}$	TX only run current DCDC, 3V $P_{RF} = -4$ dBm		4.2		mA
$I_{TX,MINUS4dBm}$	TX only run current $P_{RF} = -4$ dBm		9.3		mA
$I_{TX,MINUS8dBm,DCDC}$	TX only run current DCDC, 3V $P_{RF} = -8$ dBm		3.8		mA
$I_{TX,MINUS8dBm}$	TX only run current $P_{RF} = -8$ dBm		8.4		mA
$I_{TX,MINUS12dBm,DCDC}$	TX only run current DCDC, 3V $P_{RF} = -12$ dBm		3.5		mA
$I_{TX,MINUS12dBm}$	TX only run current $P_{RF} = -12$ dBm		7.7		mA
$I_{TX,MINUS16dBm,DCDC}$	TX only run current DCDC, 3V $P_{RF} = -16$ dBm		3.3		mA
$I_{TX,MINUS16dBm}$	TX only run current $P_{RF} = -16$ dBm		7.3		mA
$I_{TX,MINUS20dBm,DCDC}$	TX only run current DCDC, 3V $P_{RF} = -20$ dBm		3.2		mA
$I_{TX,MINUS20dBm}$	TX only run current $P_{RF} = -20$ dBm		7.0		mA
$I_{TX,MINUS40dBm,DCDC}$	TX only run current DCDC, 3V $P_{RF} = -40$ dBm		2.7		mA
$I_{TX,MINUS40dBm}$	TX only run current $P_{RF} = -40$ dBm		5.9		mA
$I_{START,TX,DCDC}$	TX start-up current DCDC, 3V, $P_{RF} = 4$ dBm		4.0		mA
$I_{START,TX}$	TX start-up current, $P_{RF} = 4$ dBm		8.8		mA

### 5.3.3. Radio Current Consumption (Receiver)

Symbol	Description	Min.	Typ.	Max.	Units
$I_{RX,1M,DCDC}$	RX only run current (DCDC, 3V) 1Msps / 1Msps BLE		5.4		mA
$I_{RX,1M}$	RX only run current 1Msps / 1Msps BLE		11.7		mA
$I_{RX,2M,DCDC}$	RX only run current (DCDC, 3V) 2Msps / 2Msps BLE		5.8		mA
$I_{RX,2M}$	RX only run current 2Msps / 2Msps BLE		12.9		mA
$I_{START,RX,DCDC}$	RX start-up current (DCDC 3V)		3.5		mA
$I_{START,RX,LDO}$	RX start-up current (LDO 3V)		7.5		mA

### 5.3.4. Transmitter Specification

Symbol	Description	Min.	Typ.	Max.	Units
$P_{RF}$	Maximum output power		4	6	dBm
$P_{RFC}$	RF power control range		24		dB
$P_{RFCR}$	RF power accuracy			±4	dB
$P_{RF1,1}$	1st Adjacent Channel Transmit Power 1 MHz (1 Msps Nordic proprietary mode)		-25		dBc
$P_{RF2,1}$	2nd Adjacent Channel Transmit Power 2 MHz (1 Msps Nordic proprietary mode)		-50		dBc
$P_{RF1,2}$	1st Adjacent Channel Transmit Power 2 MHz (2 Msps Nordic proprietary mode)		-25		dBc
$P_{RF2,2}$	2nd Adjacent Channel Transmit Power 4 MHz (2 Msps Nordic proprietary mode)		-50		dBc
$P_{RF1,2,BLE}$	1st Adjacent Channel Transmit Power 2 MHz (2 Msps BLE mode)		-20		dBc
$P_{RF2,2,BLE}$	2nd Adjacent Channel Transmit Power 4 MHz (2 Msps BLE mode)		-50		dBc

### 5.3.5. Receiver Operation

Symbol	Description	Min.	Typ.	Max.	Units
$P_{RX,MAX}$	Maximum received signal strength at < 0.1% BER		0		dBm
$P_{SENS,IT,1M}$	Sensitivity, 1Msps nRF mode <sup>1</sup>		-93		dBm
$P_{SENS,IT,SP,1M,BLE}$	Sensitivity, 1Msps BLE ideal transmitter, <=37 bytes BER=1E-3 <sup>2</sup>		-96		dBm
$P_{SENS,IT,LP,1M,BLE}$	Sensitivity, 1Msps BLE ideal transmitter >=128 bytes BER=1E-4 <sup>3</sup>		-95		dBm
$P_{SENS,IT,2M}$	Sensitivity, 2Msps nRF mode <sup>4</sup>		-89		dBm

1. Typical sensitivity applies when ADDR0 is used for receiver address correlation. When ADDR [1...7] are used for receiver address correlation, the typical sensitivity for this mode is degraded by 3dB.
2. As defined in the Bluetooth Core Specification v4.0 Volume 6: Core System Package (Low Energy Controller Volume).
3. Equivalent BER limit < 10E-04.
4. Same as remark 1.

Symbol	Description	Min.	Typ.	Max.	Units
P <sub>SENS,DT,SP,2M,BLE</sub>	Sensitivity, 2Msps BLE dirty transmitter, Packet length <=37bytes		-93		dBm
P <sub>SENS,IT,LP,2M,BLE</sub>	Sensitivity, 2Msps BLE ideal transmitter >= 128bytes		-92		dBm
P <sub>SENS,DT,LP,2M,BLE</sub>	Sensitivity, 2Msps BLE dirty transmitter, Packet length >= 128bytes		-92		dBm

### 5.3.6. RX Selectivity

Symbol	Description	Min.	Typ.	Max.	Units
C/I <sub>1M,co-channel</sub>	1Msps mode, Co-Channel interference		9		dB
C/I <sub>1M,-1MHz</sub>	1 Msps mode, Adjacent (-1 MHz) interference		-2		dB
C/I <sub>1M,+1MHz</sub>	1 Msps mode, Adjacent (+1 MHz) interference		-10		dB
C/I <sub>1M,-2MHz</sub>	1 Msps mode, Adjacent (-2 MHz) interference		-19		dB
C/I <sub>1M,+2MHz</sub>	1 Msps mode, Adjacent (+2 MHz) interference		-42		dB
C/I <sub>1M,-3MHz</sub>	1 Msps mode, Adjacent (-3 MHz) interference		-38		dB
C/I <sub>1M,+3MHz</sub>	1 Msps mode, Adjacent (+3 MHz) interference		-48		dB
C/I <sub>1M,±6MHz</sub>	1 Msps mode, Adjacent (≥6 MHz) interference		-50		dB
C/I <sub>1MBLE,co-channel</sub>	1 Msps BLE mode, Co-Channel interference		6		dB
C/I <sub>1MBLE,-1MHz</sub>	1 Msps BLE mode, Adjacent (-1 MHz) interference		-2		dB
C/I <sub>1MBLE,+1MHz</sub>	1 Msps BLE mode, Adjacent (+1 MHz) interference		-9		dB
C/I <sub>1MBLE,-2MHz</sub>	1 Msps BLE mode, Adjacent (-2 MHz) interference		-22		dB
C/I <sub>1MBLE,+2MHz</sub>	1 Msps BLE mode, Adjacent (+2 MHz) interference		-46		dB
C/I <sub>1MBLE,&gt;3MHz</sub>	1 Msps BLE mode, Adjacent (≥3 MHz) interference		-50		dB
C/I <sub>1MBLE,image</sub>	Image frequency Interference		-22		dB
C/I <sub>1MBLE,image,1MHz</sub>	Adjacent (1 MHz) interference to in-band image frequency		-35		dB
C/I <sub>1MBLE,image</sub>	Image frequency Interference		-22		dB
C/I <sub>1MBLE,image,1MHz</sub>	Adjacent (1 MHz) interference to in-band image frequency		-35		dB
C/I <sub>2M,co-channel</sub>	2Msps mode, Co-Channel interference		10		dB
C/I <sub>2M,-2MHz</sub>	2 Msps mode, Adjacent (-2 MHz) interference		6		dB
C/I <sub>2M,+2MHz</sub>	2 Msps mode, Adjacent (+2 MHz) interference		-14		dB
C/I <sub>2M,-4MHz</sub>	2 Msps mode, Adjacent (-4 MHz) interference		-20		dB
C/I <sub>2M,+4MHz</sub>	2 Msps mode, Adjacent (+4 MHz) interference		-44		dB
C/I <sub>2M,-6MHz</sub>	2 Msps mode, Adjacent (-6 MHz) interference		-42		dB
C/I <sub>2M,+6MHz</sub>	2 Msps mode, Adjacent (+6 MHz) interference		-47		dB
C/I <sub>2M,≥12MHz</sub>	2 Msps mode, Adjacent (≥12 MHz) interference		-52		dB
C/I <sub>2MBLE,co-channel</sub>	2 Msps BLE mode, Co-Channel interference		7		dB
C/I <sub>2MBLE,±2MHz</sub>	2 Msps BLE mode, Adjacent (±2 MHz) interference		0		dB
C/I <sub>2MBLE,±4MHz</sub>	2 Msps BLE mode, Adjacent (±4 MHz) interference		-47		dB
C/I <sub>2MBLE,≥6MHz</sub>	2 Msps BLE mode, Adjacent (≥6 MHz) interference		-49		dB
C/I <sub>2MBLE,image</sub>	Image frequency Interference		-21		dB
C/I <sub>2MBLE,image, 2MHz</sub>	Adjacent (2 MHz) interference to in-band image frequency		-36		dB

Remark: Wanted signal level at PIN = -67 dBm. One interferer is used, having equal modulation as the wanted signal. The input power of the interferer where the sensitivity equals BER = 0.1% is presented.



### 5.3.7. RX Intermodulation

Symbol	Description	Min.	Typ.	Max.	Units
P <sub>IMD,1M</sub>	IMD performance, 1 Msps (3 MHz, 4 MHz, and 5 MHz offset)		-33		dBm
P <sub>IMD,1M,BLE</sub>	IMD performance, BLE 1 Msps (3 MHz, 4 MHz, and 5 MHz offset)		-30		dBm
P <sub>IMD,2M</sub>	IMD performance, 2 Msps (6 MHz, 8 MHz, and 10 MHz offset)		-33		dBm
P <sub>IMD,2M,BLE</sub>	IMD performance, BLE 2 Msps (6 MHz, 8 MHz, and 10 MHz offset)		-32		dBm

Remark: Wanted signal level at PIN = -64dBm. Two interferers with equal input power are used. The interferer closest in frequency is not modulated, the other interferer is modulated equal with the wanted signal. The input power of the interferers where the sensitivity equals BER = 0.1% is presented.

### 5.3.8. Radio Timing Parameters

Symbol	Description	Min.	Typ.	Max.	Units
t <sub>TXEN</sub>	Time between TXEN task and READY event after channel FREQUENCY configured		140		us
t <sub>TXEN,FAST</sub>	Time between TXEN task and READY event after channel FREQUENCY configured (Fast Mode)		40		us
t <sub>TXDISABLE</sub>	Time between DISABLE task and DISABLED event when the radio was in TX and mode is set to 1Msps		6		us
t <sub>TXDISABLE,2M</sub>	Time between DISABLE task and DISABLED event when the radio was in TX and mode is set to 2Msps		4		us
t <sub>RXEN</sub>	Time between the RXEN task and READY event after channel FREQUENCY configured in default mode		140		us
t <sub>RXEN,FAST</sub>	Time between the RXEN task and READY event after channel FREQUENCY configured in fast mode		40		us
t <sub>SWITCH</sub>	The minimum time taken to switch from RX to TX or TX to RX (channel FREQUENCY unchanged)		20		us
t <sub>RXDISABLE</sub>	Time between DISABLE task and DISABLED event when the radio was in RX		0		us
t <sub>TXCHAIN</sub>	TX chain delay		0.6		us
t <sub>RXCHAIN</sub>	RX chain delay		9.4		us
t <sub>RXCHAIN,2M</sub>	RX chain delay in 2Msps mode		5		us

### 5.3.9. RSSI Specifications

Symbol	Description	Min.	Typ.	Max.	Units
RSSI <sub>ACC</sub>	RSSI Accuracy Valid range -90 to -20 dBm		±2		dB
RSSI <sub>RESOLUTION</sub>	RSSI resolution		1		dB
RSSI <sub>PERIOD</sub>	Sample period		0.25		us

## 5.3.10. CPU

Symbol	Description	Min.	Typ.	Max.	Units
$W_{FLASH}$	CPU wait states, running from flash, cache disabled	0		2	
$W_{FLASHCACHE}$	CPU wait states, running from flash, cache enabled	0		3	
$W_{RAM}$	CPU wait states, running from RAM			0	
$I_{DDFLASHCACHE}$	CPU current, running from flash, cache enabled, LDO		7.4		mA
$I_{DDFLASHCACHEDCDC}$	CPU current, running from flash, cache enabled, DCDC 3V		3.7		mA
$I_{DDFLASH}$	CPU current, running from flash, cache disabled, LDO		8.0		mA
$I_{DDFLASHDCDC}$	CPU current, running from flash, cache disabled, DCDC 3V		3.9		mA
$I_{DDRAM}$	CPU current, running from RAM, LDO		6.7		mA
$I_{DDRAMDCDC}$	CPU current, running from RAM, DCDC 3V		3.3		mA
$I_{DDFLASH/MHz}$	CPU efficiency, running from flash, cache enabled, LDO		125		$\mu A/$ MHz
$I_{DDFLASHDCDC/MHz}$	CPU efficiency, running from flash, cache enabled, DCDC 3V		58		$\mu A/$ MHz
$CM_{FLASH}$	CoreMark <sup>5</sup> , running from flash, cache enabled		215		CoreM
$CM_{FLASH/MHz}$	CoreMark per MHz, running from flash, cache enabled		3.36		CoreM MHz
$CM_{FLASH/mA}$	CoreMark per mA, running from flash, cache enabled, DCDC 3V		58		CoreM mA

## 5.3.11. Power Management

Symbol	Description	Min.	Typ.	Max.	Units
$I_{ON\_RAMOFF\_EVENT}$	System ON, No RAM retention, Wake on any event		1.2		$\mu A$
$I_{ON\_RAMON\_EVENT}$	System ON, Full RAM retention, Wake on any event		1.5		$\mu A$
$I_{ON\_RAMOFF\_RTC}$	System ON, No RAM retention, Wake on RTC		1.9		$\mu A$
$I_{OFF\_RAMOFF\_RESET}$	System OFF, No RAM retention, Wake on reset		0.3		$\mu A$
$I_{OFF\_RAMOFF\_GPIO}$	System OFF, No RAM retention, Wake on GPIO		0.3		$\mu A$
$I_{OFF\_RAMOFF\_LPCOMP}$	System OFF, No RAM retention, Wake on LPCOMP		1.9		$\mu A$
$I_{OFF\_RAMOFF\_NFC}$	System OFF, No RAM retention, Wake on NFC field		0.7		$\mu A$
$I_{OFF\_RAMON\_RESET}$	System OFF, Full 64 kB RAM retention, Wake on reset		0.7		$\mu A$

# 6. Block Diagram

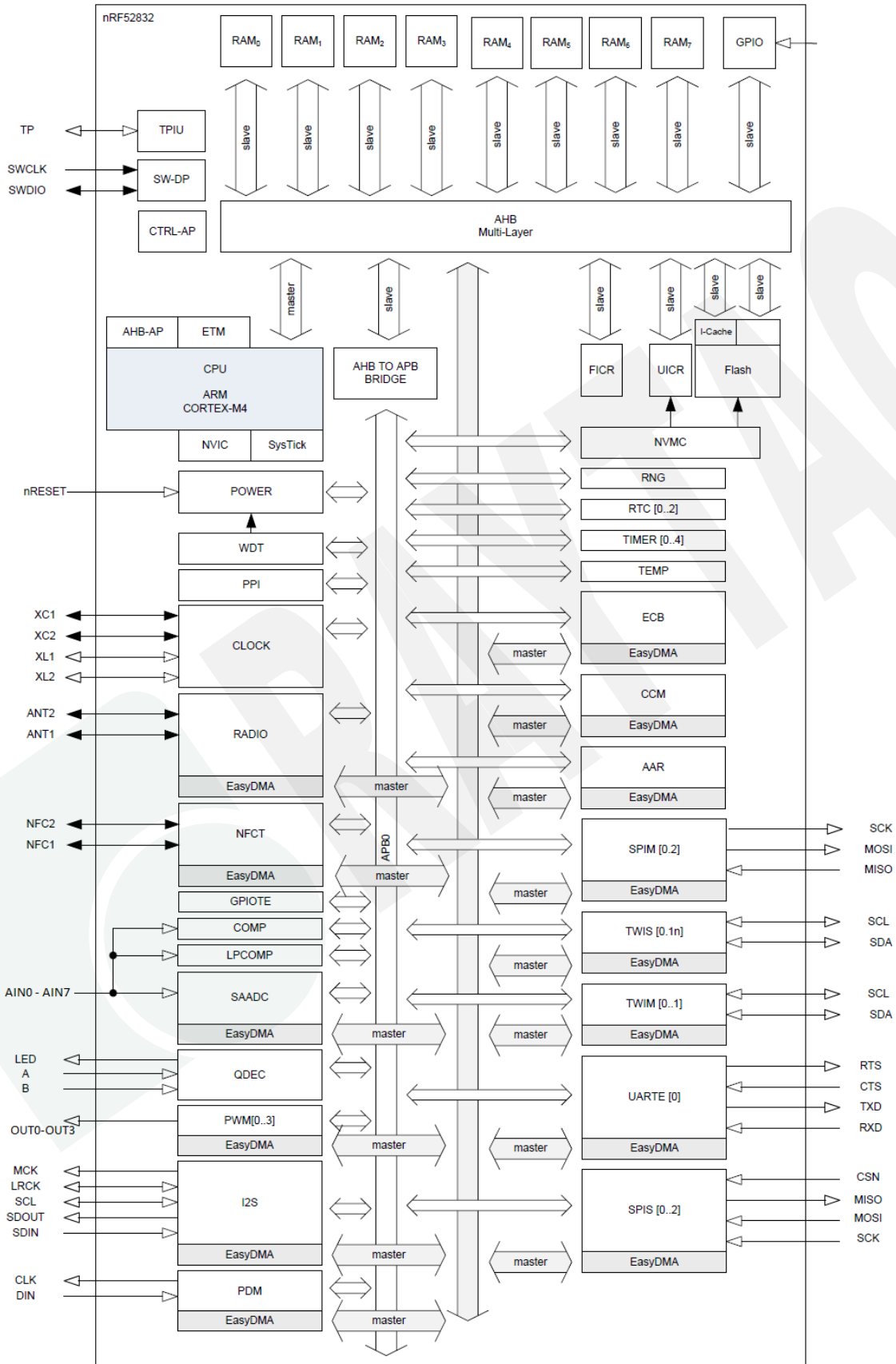

# 7. Antenna

## 7.1. MDBT42V

### Test Result

Frequency (MHz)	2400	2410	2420	2430	2440	2450	2460	2470	2480	2490	2500
Gain (dBi)	-1.26	-1.12	-1.13	-1.29	-1.55	-1.89	-2.32	-2.81	-3.39	-3.88	-4.59
Peak EIRP (dBm)	-1.26	-1.12	-1.13	-1.29	-1.55	-1.89	-2.32	-2.81	-3.39	-3.88	-4.59
Directivity (dBi)	4.81	4.87	4.91	4.96	4.99	5.01	4.99	4.98	4.92	4.88	4.95

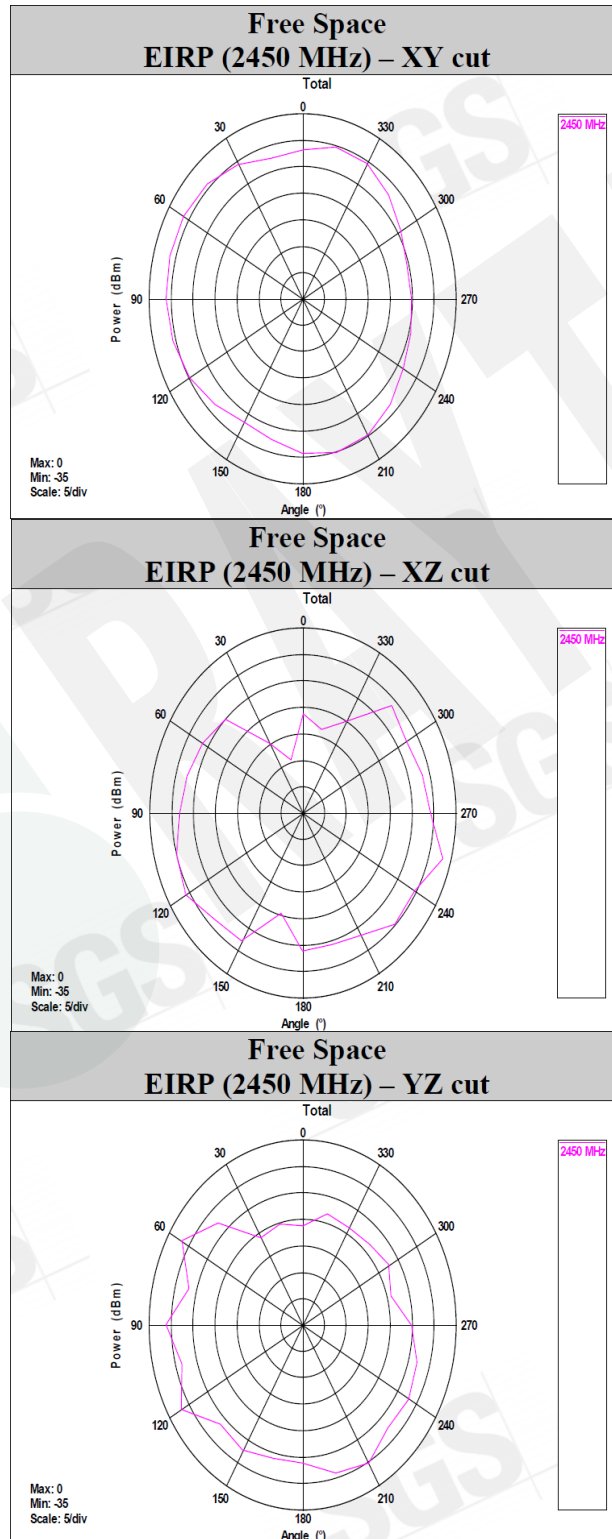

## 7.2. MDBT42V-P

### Test Result

Frequency (MHz)	2400	2410	2420	2430	2440	2450	2460	2470	2480	2490	2500
Gain (dBi)	-3.85	-3.81	-3.92	-4.00	-4.07	-4.14	-4.22	-4.32	-4.46	-4.63	-5.13
Peak EIRP (dBm)	-3.85	-3.81	-3.92	-4.00	-4.07	-4.14	-4.22	-4.32	-4.46	-4.63	-5.13
Directivity (dBi)	5.29	5.36	5.36	5.43	5.51	5.49	5.45	5.37	5.33	5.31	5.30

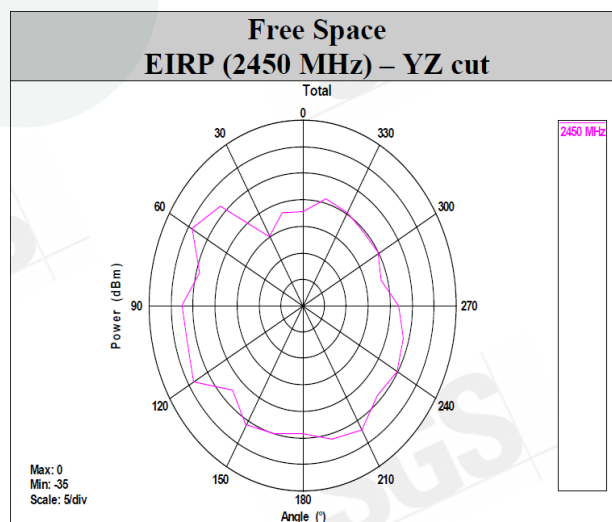
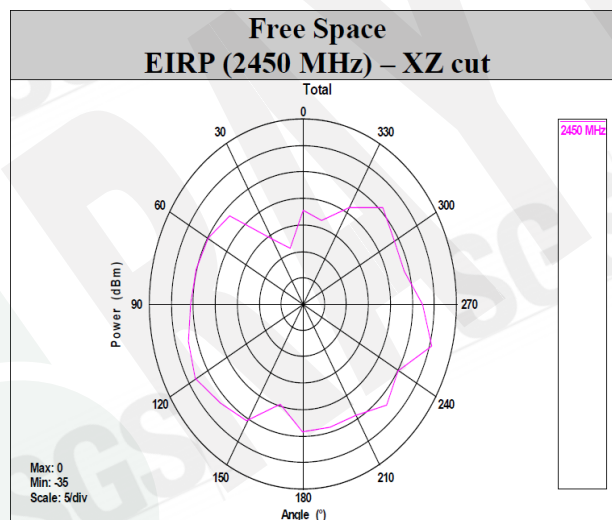
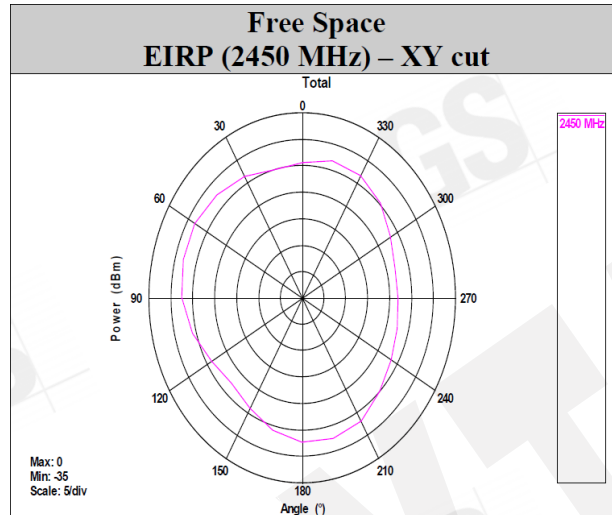

# 8. Reference Circuit

Module is pre-programmed with Raytac's testing code. Default is using "LDO mode". Our firmware is set to use external 32.768khz so please add it to make module work.

**REMARK:**

- \*\* When using DC-DC mode, please add L2 / L3 / C14. \*\*
- \*\* When **NOT** using NFC, please remove NFC1 / C19 / C21. \*\*
- \*\* When using internal 32.768khz RC oscillator, please remove X2 / C12 / C13. \*\*

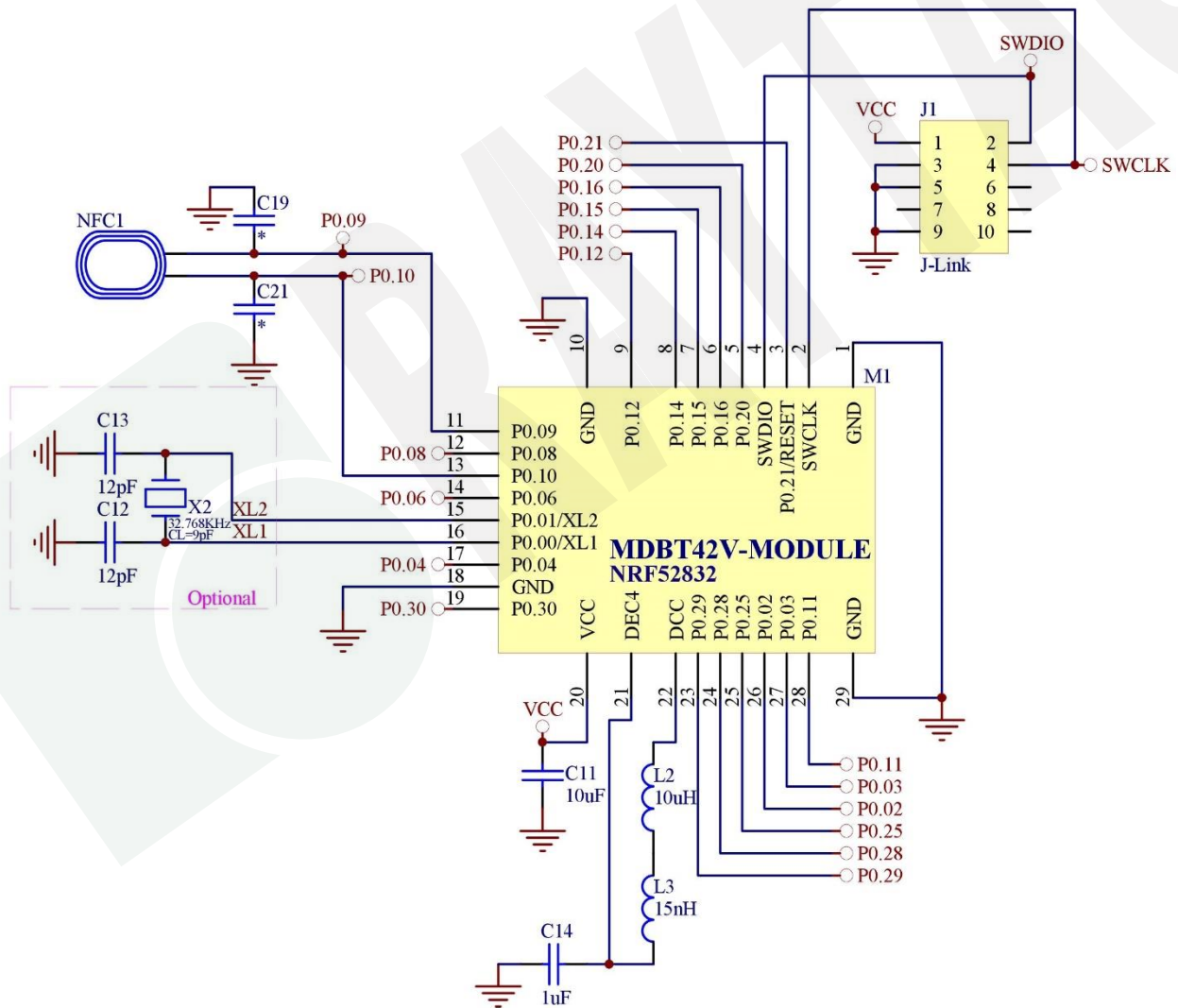

## 9. Certification

### 9.1. Declaration ID

#### BT 5.1

Declaration ID	QDID(s)	Company	Specification Name
D047708	139361 - End Product	Raytac Corporation	5.1

#### BT 5.2

Declaration ID	QDID(s)	Company	Specification Name
D053149	159932 - End Product	Raytac Corporation	5.2

Profile Description	Service Description
Alert Notification Profile	Alert Notification Service
Blood Pressure Profile	Blood Pressure Service
	Device Information Service
Cycling Speed & Cadence Profile	Cycling Speed & Cadence Service
	Device Information Service
Glucose Profile	Glucose Service
	Device Information Service
Health Thermometer Profile	Health Thermometer Service
	Device Information Service
Heart Rate Profile	Heart Rate Service
	Device Information Service
HID over GATT Profile	HID Service
	Battery Service
Proximity Profile	Link Loss Service
	Immediate Alert Service
	TX Power Service
Running Speed & Cadence Profile	Running Speed & Cadence Service
	Device Information Service
Time Profile	Time Profile Service
Glucose Profile (Central)	
Mesh Profile	Mesh Provisioning Service
	Mesh Proxy Service



## 9.2. FCC Certificate (USA)



TCB

**GRANT OF EQUIPMENT  
AUTHORIZATION**

Certification  
Issued Under the Authority of the  
Federal Communications Commission

By:

Telefication B.V.  
Edisonstraat 12a  
Zevenaar, NL-6902 PK  
Netherlands

TCB

Date of Grant: 09/07/2017

Application  
Dated: 09/05/2017

**Raytac Corp.**  
5F., No.3, Jiankang Rd., Zhonghe Dist.,  
New Taipei City,, 23586  
Taiwan

Attention: Venson Liao , R&D Manager

**NOT TRANSFERABLE**

EQUIPMENT AUTHORIZATION is hereby issued to the named  
GRANTEE, and is VALID ONLY for the equipment identified hereon for  
use under the Commission's Rules and Regulations listed below.

**FCC IDENTIFIER:** SH6MDBT42V

**Name of Grantee:** Raytac Corp.

**Equipment Class:** Digital Transmission System

**Notes:** BT 4.2 Module

**Modular Type:** Single Modular

Grant Notes	FCC Rule Parts	Frequency Range (MHZ)	Output Watts	Frequency Emission Tolerance Designator
	15C	2402.0 - 2480.0	0.0029	

Modular Approval. Power output listed is conducted. This grant is valid only when the module is sold to OEM integrators and must be installed by the OEM or OEM integrators. The antennas used for this transmitter as shown in this filing must be installed to provide a separation distance of at least 5 cm from all persons and must not be co-located or operating in conjunction with any other antenna or transmitter. End-users may not be provided with the module installation instructions. OEM integrators and end-users must be provided with transmitter operating conditions for satisfying RF exposure compliance.

Certificate No.:  
172181318/AA/00

George Lo  
Product Assessor



## 9.3. TELEC Certificate (Japan)

telefication bv  
The Netherlands  
Chamber of Commerce  
51565536  
www.telefication.com



**Certificate**  
of  
Radio Equipment in JAPAN

No: 201-170920 / 00

Telefication, operating as Conformity Assessment Body (CAB ID Number: 201) with respect to Japan, declares that the listed product complies with the Technical Regulations Conformity Certification of Specified Radio equipment (ordinance of MPT N° 37,1981)

Product description: BT 4.2 Module  
Trademark: Raytac  
Type designation: MDBT42V  
Hardware / Software version: 1 / 1  
Variants: See Annex 3

Manufacturer: Raytac Corporation  
Address: 5F, No. 3, Jiankang Rd., Zhonghe Dist.  
City: 23586 New Taipei City  
Country: Taiwan

This statement is granted to:

Name: Raytac Corporation  
Address: 5F, No. 3, Jiankang Rd., Zhonghe Dist.  
City: 23586 New Taipei City  
Country: Taiwan

This statement has THREE Annexes.

Zevenaar, 12 September 2017

**CAB**

  
Ramy Nabod  
Product Assessor



## 9.4. NCC Certificate (Taiwan)

### MDBT42V Series

	<b>台灣檢驗科技股份有限公司</b> <b>電信管制射頻器材型式認證證明</b>
一、申請者：	勁達國際電子有限公司
二、地址：	新北市中和區建康路3號5樓
三、製造廠商：	勁達國際電子有限公司
四、器材名稱：	BT 4.2 Module
五、廠牌：	Raytac
六、型號：	MDBT42V
七、發射功率： (電場強度) (Peak)	BT V4.2 single mode LE (GFSK): 4.57dBm
八、工作頻率：	2402-2480MHz
九、審驗日期：	106年09月12日
十、審驗合格標籤式樣：	
十一、警語或標示要求：	<p>1. 應依審驗合格標籤或符合性聲明標籤式樣自製標籤黏貼或印鑄於電信管制射頻器材本體明顯處，並於包裝盒標示本會標章，始得公開陳列或販賣。</p> <p>2. 電信管制射頻器材應依本會或相關技術規範規定於指定位置標示中文警語。</p> <p>3. 使用原審驗合格標籤者，應於說明書及包裝盒提供充分與正確之資訊。</p> <p>4. 於網際網路販售取得審驗證明之電信管制射頻器材者，應於該網際網路網頁提供審驗合格標籤或符合性聲明標籤資訊。</p> <p>5. 使用手冊應標示下列資訊： (1) 標型式認證合格之低功率射頻電機，非經許可，公司、商號或使用者均不得擅自變更頻率、加大功率或變更原設計之特性及功能。低功率射頻電機之使用不得影響飛航安全及干擾合法通信；經發現有干擾現象時，應立即停用，並改善至無干擾時方得繼續使用。前項合法通信，指依電信法規定作業之無線電通信。低功率射頻電機須忍受合法通信或工業、科學及醫療用電波輻射性電機設備之干擾。</p>
十二、特殊記載事項：	<p>1. 本案審驗模組為完全模組，適用於任何平臺。</p> <p>2. 「平臺」指不組裝射頻模組(組件)，仍具備平臺主要功能之器材。</p> <p>3. 經取得審驗證明之電信管制射頻器材或射頻模組(組件)，如變更其廠牌、型號、技術規格或射頻性能時，除電信管制射頻器材審驗辦法另有規定外，應重新申請審驗。</p> <p>4. 經取得審驗證明之電信管制射頻器材或射頻模組(組件)，於電信管制射頻器材相關技術規範修訂審驗相關章節時，應依下列規定辦理： (1) 修訂後之技術規範明定實施期限者，依實施期限，申請重新審驗。 (2) 修訂後之技術規範未明定實施期限者，應於技術規範修訂後二年內，申請重新審驗。經取得審驗證明之電信管制射頻器材，於電信管制射頻器材相關技術規範修訂審驗相關章節時，修訂後之技術規範未明定實施期限者，應於技術規範修訂後二年內，申請重新審驗。未依規定重新審驗者，原驗證機關(構)得廢止其審驗證明。</p> <p>5. 取得型式認證證明、符合性聲明證明及符合性聲明證明者，應妥善保管申請審驗器材樣品、測試所需之特殊測試軟體及特殊治具至該器材停止生產或停止輸入後五年。</p> <p>6. 取得型式認證證明或符合性聲明證明者授權他人於同廠牌同型號之電信管制射頻器材或射頻模組(組件)使用審驗合格標籤或符合性聲明標籤，應由取得審驗證明者於本會指定位置登錄。</p> <p>7. 以取得審驗證明之射頻模組(組件)組裝於最終產品後，取得審驗證明者，應於該最終產品輸入、販賣或公開陳列前，檢具標註最終產品廠牌、型號及外觀照片之電子檔，向原驗證機關(構)登錄；以射頻模組(組件)取得審驗證明者，授權他人使用其審驗合格標籤，該射頻模組(組件)組裝於最終產品後，取得審驗證明者應檢具標註最終產品廠牌、型號及外觀照片之電子檔，向原驗證機關(構)登錄。</p>
說明：	<p>1. 本公司/中心係經國家通訊傳播委員會委託之驗證機構(證書號碼：NCC-RCB-13，機構地址：台灣檢驗科技股份有限公司、電話：02-2299 3279)，核發本型式認證證明。</p> <p>2. 請依上列標籤式樣自製標籤，標貼或印鑄於器材本體明顯處，始得販賣或公開陳列。</p> <p>3. 本設備之製造、輸入、販售、使用等均需遵守相關電信法規之規定。</p>
備註：	<p>1. 本器材符合低功率射頻電機技術規範(3.10.1)之規定。</p> <p>2. 本公司僅對無線射頻特性技術規範辦理型式認證，其他仍須依本國相關法規辦理。</p> <p>3. 本器材使用天線型態：Chip Antenna，天線廠牌：Raytac，Model No.: MDBT42V，增益：-1.12dBi。</p> <p>4. 本公司係經國家通訊傳播委員會委託之驗證機構，核發本型式認證證明。</p>

## MDBT42V-P Series



# 台灣檢驗科技股份有限公司 電信管制射頻器材型式認證證明

- 一、申請者：勁達國際電子有限公司  
二、地址：新北市中和區建康路3號5樓  
三、製造廠商：勁達國際電子有限公司  
四、器材名稱：BT 4.2 Module  
五、廠牌：Raytac  
六、型號：MDBT42V-P  
七、發射功率：BT V4.2 single mode LE (GFSK): 4.57dBm  
(電場強度) (Peak)  
八、工作頻率：2402-2480MHz  
九、審驗日期：106年09月12日  
十、審驗合格標籤式樣：



### 十一、警語或標示要求：

- 應依審驗合格標籤或符合性聲明標籤式樣自製標籤黏貼或印鑄於電信管制射頻器材本體明顯處，並於包裝盒標示本會標章，始得公開陳列或販賣。
- 電信管制射頻器材應依本會或相關技術規範規定於指定位置標示中文警語。
- 使用原審驗合格標籤者，應於說明書及包裝盒提供充分與正確之資訊。
- 於網際網路販賣取得審驗證明之電信管制射頻器材者，應於該網際網路網頁提供審驗合格標籤或符合性聲明標籤資訊。
- 使用者應標示下列資訊：  
(1) 標型式認證合格之低功率射頻電機，非經許可，公司、商號或使用者均不得擅自變更頻率、加大功率或變更原設計之特性及功能。低功率射頻電機之使用不得影響飛航安全及干擾合法通信；經發現有干擾現象時，應立即停用，並改善至無干擾時方得繼續使用。前項合法通信，指依電信法規定作業之無線電通信。低功率射頻電機須忍受合法通信或工業、科學及醫療用電波輻射性電機設備之干擾。

### 十二、特殊記載事項：

- 本案審驗模組為完全模組，適用於任何平臺。
- 「平臺」指不組裝射頻模組(組件)，仍具備平臺主要功能之器材。
- 除取得審驗證明之電信管制射頻器材或射頻模組(組件)，如變更其廠牌、型號、技術規格或射頻性能時，除電信管制射頻器材審辦法另有規定外，應重新申請審驗。
- 除取得審驗證明之電信管制射頻器材或射頻模組(組件)，於電信管制射頻器材相關技術規範修訂審驗相關章節時，應依下列規定辦理：  
(1) 修訂後之技術規範明定實施期限者，依實施期限，申請重新審驗。  
(2) 修訂後之技術規範未明定實施期限者，應於技術規範修訂後二年內，申請重新審驗。經取得審驗證明之電信管制射頻器材，於電信管制射頻器材相關技術規範修訂審驗相關章節時，修訂後之技術規範未明定實施期限者，應於技術規範修訂後二年內，申請重新審驗。未依規定重新審驗者，原驗證機關(構)得廢止其審驗證明。
- 取得型式認證證明、符合性聲明證明及隨書符合性聲明證明者，應妥善保管申請審驗器材樣品、測試所需之特殊測試軟體及特殊治具至該器材停止生產或停止輸入後五年。
- 取得型式認證證明或符合性聲明證明者授權他人於同廠牌同型號之電信管制射頻器材或射頻模組(組件)使用審驗合格標籤或符合性聲明標籤，應由取得審驗證明者於本會指定位置登錄。
- 以取得審驗證明之射頻模組(組件)組裝於最終產品後，取得審驗證明者，應於該最終產品輸入、販賣或公開陳列前，檢具標註最終產品廠牌、型號及外觀照片之電子檔，向原驗證機關(構)登錄；以射頻模組(組件)取得審驗證明者，授權他人使用其審驗合格標籤、該射頻模組(組件)組裝於最終產品後，取得審驗證明者應檢具標註最終產品廠牌、型號及外觀照片之電子檔，向原驗證機關(構)登錄。

### 說明：

- 本公司/中心係經國家通訊傳播委員會委託之驗證機構(證書號碼：NCC-RCB-13，機構地址：台灣檢驗科技股份有限公司、電話：02-2299 3279)，核發本型式認證證明。
- 請依上列標籤式樣自製標籤，標貼或印鑄於器材本體明顯處，始得販賣或公開陳列。
- 本設備之製造、輸入、販賣、使用等均需遵守相關電信法規之規定。

### 備註：

- 本器材符合低功率射頻電機技術規範(3.10.1)之規定。
- 本公司僅對無線射頻特性技術規範辦理型式認證，其他仍須依本國相關法規辦理。
- 本器材使用天線型態：PCB Antenna，天線廠牌：Raytac，Model No.：MDBT42V-P，增益：-3.81dBi。
- 本公司係經國家通訊傳播委員會委託之驗證機構，核發本型式認證證明。

## 9.5. CE Test Report (EU)

	Report No.: E2/2017/80017-01 Page: 1 of 58
 <b>RED (2014/53/EU)</b> <b>ETSI EN 300 328 V2.2.2 : 2019</b> <b>TEST REPORT</b>	
<hr/> <b>FOR</b>	
<b>Applicant:</b>	Raytac Corporation 5F, No.3, Jiankang Rd., Zhonghe Dist., New Taipei City , 23586, Taiwan
<b>Product Name:</b>	BLE Module
<b>Brand Name:</b>	Raytac
<b>Model No.:</b>	MDBT42V, MDBT42V-P
<b>Model Difference:</b>	MDBT42V with chip antenna; MDBT42V-P with PCB antenna
<b>Report Number:</b>	E2/2017/80017-01
<b>Issue Date:</b>	May 20, 2020
<b>Date of Test:</b>	Aug. 01, 2017 ~ Aug. 24, 2017 (Original) Apr. 16, 2020 ~ May 11, 2020 (Updated)
<b>Date of EUT Received:</b>	Aug. 01, 2017 (Original) Apr. 16, 2020 (Updated)
<b>We hereby certify that:</b>	The above equipment was tested by SGS Taiwan Ltd., Electronics & Communication Laboratory for compliance with the requirements set forth in the European Standard ETSI EN 300 328 V2.2.2: 2019 under RED 2014/53/EU. The results of testing in this report apply to the product system that was tested only. Other similar equipment will not necessarily produce the same results due to production tolerance and measurement uncertainties.
<b>Approved By:</b>	 <u>CHUN-CHIEH, CHEN / Supervisor</u>
	 



SGS Reference No: E1/2017/80007C

## VERIFICATION OF EMC COMPLIANCE

Verification No. : E1/2017/80007C  
Representative Model No. : MDBT42V  
Added Model(s) : MDBT42V-P  
Product Name : BT 4.2 Module  
Brand Name : Raytac  
Applicant : Raytac Corporation  
Address of Applicant : 5F, No.3, Jiankang Rd., Zhonghe Dist., New Taipei City , 23586, Taiwan  
Test Report Number : E1/2017/80007  
Date of Issue : Sep. 04, 2017  
Applicable Standards : EN 301 489 -1 v2.2.0: 2017-03 (Draft)  
EN 301 489 -17 v3.2.0: 2017-03 (Draft)  
EN 55032 : 2015+AC:2016-07  
EN 61000-4-2 : 2009, EN 61000-4-3 : 2006+A1:2008+A2:2010

### Conclusion

The apparatus meets the requirements of the above standards and hence compliance the essential requirements under article 3.1b of the RED (2014/53/EU) Directive.

\*This verification is only valid for the equipment and configuration described, and in conjunction with the test report as detailed above.

Authorized Signatory:

SGS TAIWAN LTD.  
Eddy Cheng  
Technical Asst. Supervisor

## 9.6. IC Certificate (Canada)

<p><b>telefication bv</b> The Netherlands Chamber of Commerce 51565536 www.telefication.com</p>				
<p><b>TECHNICAL ACCEPTANCE CERTIFICATE</b></p>		<p><b>CERTIFICAT D'ACCEPTABILITÉ TECHNIQUE</b></p>		
CERTIFICATION No. No. DE CERTIFICATION	8017A-MDBT42V			
TELEFICATION No. No. DE TELEFICATION	172170518/AA/00			
TEST SITE No. No. DE LABORATOIRE	4620A-5			
ISSUED TO DÉLIVRÉ À	Raytac Corporation			
TYPE OF EQUIPMENT GENRE DE MATÉRIEL	Bluetooth device			
TRADE NAME AND MODEL MARQUE ET MODELE	Raytac / MDBT42V Raytac / MDBT42V-P			
CERTIFIED TO CERTIFIÉ SELON LE	SPECIFICATION CAHIER DES CHARGES	RSS-102 RSS-247	ISSUE EDITION	5 2
<p>Certification of equipment means only that the equipment has met the requirements of the above-noted specification. Licence applications, where applicable to use certified equipment, are acted on accordingly by the ISED issuing office and will depend on the existing radio environment, service and location of operation. This certificate is issued on condition that the holder complies and will continue to comply with the requirements and procedures issued by ISED. The equipment for which this certificate is issued shall not be manufactured, imported, distributed, leased, offered for sale or sold unless the equipment complies with the applicable technical specifications and procedures issued by ISED.</p>		<p>La certification du matériel signifie seulement que le matériel a satisfait aux exigences de la norme indiquée ci-dessus. Les demandes de licences nécessaires pour l'utilisation du matériel certifié sont traitées en conséquence par le bureau de délivrance d'ISDE et dépendent des conditions radio ambiantes, du service et de l'emplacement d'exploitation. Le présent certificat est délivré à la condition que le titulaire satisfasse et continue de satisfaire aux exigences et aux procédures d'ISDE. Le matériel à l'égard duquel le présent certificat est délivré ne doit pas être fabriqué, importé, distribué, loué, mis en vente ou vendu à moins d'être conforme aux procédures et aux spécifications techniques applicables publiées par ISDE.</p>		
<p>ISSUED BY TELEFICATION BV (NL0001), RECOGNIZED CERTIFICATION BODY BY INNOVATION, SCIENCE AND ECONOMIC DEVELOPMENT CANADA DÉLIVRÉ PAR TELEFICATION BV (NL0001), ORGANISME DE CERTIFICATION RECONNU PAR INNOVATION, SCIENCES ET DÉVELOPPEMENT ÉCONOMIQUE CANADA</p>				
<p><i>I hereby attest that the subject equipment was tested and found in compliance with the above-noted specification. J'atteste, par la présente, que le matériel a fait l'objet d'essai et a été jugé conforme à la spécification ci-dessus</i></p>				
DATE 07 Sep 2017 BY	George Lo Product Assessor			
This certificate has one annex.				

## 9.7. SRRC Certificate (China)

**无线电发射设备**  
Radio Transmission Equipment  
**型号核准证**  
Type Approval Certificate

劲达国际电子有限公司(台湾)：

**根据《中华人民共和国无线电管理条例》**  
In accordance with the provisions on the Radio  
**Regulations of the People's Republic of China , the following**  
**符合中华人民共和国无线电管理规定和**  
radio transmission equipment , after examination , conforms  
**技术标准，其核准代码为：** CMIIT ID: 2017DJ5872  
to the provisions with its CMIIT ID:

有效期： 2025-09-14  
Validity

  
Sealed by issuing authority

2022 09月 02日  
Year Month Date



## 9.8. KC Certificate (South Korea)

E6D1-6EEE-953F-AC29

<b>방송통신기자재등의 적합인증서</b> <i>Certificate of Broadcasting and Communication Equipments</i>	
상호 또는 성명 <i>Trade Name or Applicant</i>	Raytac Corporation
기자재명칭(명칭) <i>Equipment Name</i>	특정소출력 무선기기(무선데이터통신시스템용 무선기기)
기본모델명 <i>Basic Model Number</i>	MDBT42V
파생모델명 <i>Series Model Number</i>	MDBT42V-P
인증번호 <i>Certification No.</i>	R-C-ryt-MDBT42V
제조사/제조국가 <i>Manufacturers/ Country of Origin</i>	Raytac Corporation / 대만
인증연월일 <i>Date of Certification</i>	2020-09-14
기타 <i>Others</i>	
<p>위 기자재는 「전파법」 제58조의2 제2항에 따라 인증되었음을 증명합니다.</p> <p>It is verified that foregoing equipment has been certificated under the Clause 2, Article 58-2 of Radio Waves Act.</p> <p style="text-align: right;">2020년(Year) 09월(Month) 14일(Day)</p> <p style="text-align: center;">국립전파연구원장 </p> <p style="text-align: center;"><i>Director General of National Radio Research Agency</i></p> <p style="text-align: center; color: red; font-size: small;">※ 인증 받은 방송통신기자재는 반드시 "적합성평가표시" 를 부착하여 유통하여야 합니다. 위반시 과태료 처분 및 인증이 취소될 수 있습니다.</p>	

## 9.9. RoHS & REACH Report

Please visit "[Support](#)" page of our website to download.

## 9.10. End-Product Label

It is suggested using following content adding to package or user manual or label to obey the regulation. Any rules of end-product label shall refer to each certification for final reference.

### 9.10.1. FCC (USA)

The FCC statement should be included in the user manual when there is no enough space on label. Otherwise, it should be included on the label.

"This device complies with part 15 of the FCC rules. Operation is subject to the following two conditions. (1) This device may not cause harmful interference. (2) This device must accept any interference received, including interference that may cause undesired operation."

The final end product must be labeled in a visible area with the following: "Contain FCC ID: SH6MDBT42V".

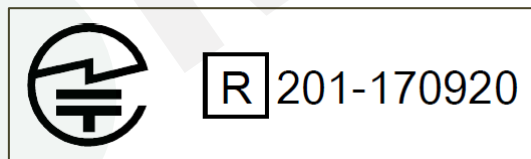

### 9.10.2. TELEC (Japan)

When manufacturer is placing the product on the Japanese market, the product must be affixed with the following Specified Radio Equipment marking:



### 9.10.3. NCC (Taiwan)

請依下列標籤式樣自製標籤，標貼或印鑄於器材本體明顯處，始得販賣或公開陳列。

Series	標籤樣式
MDBT42V Series	
MDBT42V-P Series	

以 MDBT42V 為例，平台廠商必須於平台上標示字樣「本產品內含射頻模組：ID 編號 CCAM17LP1390T5」。

「平台」定義如下：若器材組裝本案模組，消費者仍能正常使用該器材主要功能，該器材得視為平台。若器材不組裝本案模組，消費者不能正常使用該器材主要功能，該器材不能視為平台。該類不同廠牌型號器材組裝本案審驗模組後，須分別申請型式認證。

### 9.10.4. IC (Canada)

The IC statement should be included in the user manual when there is no enough space on label. Otherwise, it should be included on the label.

“This device complies with Industry Canada license-exempt RSS Standard(s). Operation is subject to the following two conditions. (1) This device may not cause harmful interference. (2) This device must accept any interference received, including interference that may cause undesired operation.

Le présent appareil est conforme aux CNR d'Industrie Canada applicables aux appareils radio exempts de licence. L'exploitation est autorisée aux deux conditions suivantes: (1) l'appareil ne doit pas produire de brouillage, et (2) l'utilisateur de l'appareil doit accepter tout brouillage radioélectrique subi, même si le brouillage est susceptible d'en compromettre le fonctionnement.”

The final end product must be labeled in a visible area with the following: “Contain IC ID: 8017A-MDBT42V”.

## 10. Notes and Cautions

Module is not designed to be used and lasting a lifetime. Like general products, it is expected to be worn out after continuous usage through the years. To assure that product will perform better and last longer, please make sure you

- Follow the guidelines of this document while designing circuit/end-product. Any discrepancy of core Bluetooth technology and technical specification of IC should refer to definition of Bluetooth Organization and Nordic Semiconductor as final reference.
- Do not supply voltage that is not within range of specification.
- Eliminate static electricity at any methods when working with the module as it may cause damage. It is highly recommended adding anti-ESD components to circuit design to prevent damage from real-life ESD events. Anti-ESD methods can be also applied in mechanical design.
- Do not expose modules under direct sunlight for long duration. Modules should be kept away from humid and salty air conditions, and any corrosive gasses or substances. Store it within  $-40^{\circ}\text{C}$  to  $+125^{\circ}\text{C}$  before and after installation.
- Avoid any physical shock, intense stress to the module or its surface.
- Do not wash the module. No-Clean Paste is used in production. Washing it will oxidize the metal shield and have chemistry reaction with No-Clean Paste. Functions of the module are not guaranteed if it has been washed.

The module is not suitable for life support devices or systems and is not allowed to be used in destructive devices or systems in any direct, or indirect ways. The customer agrees to indemnify Raytac for any losses when using module(s) in applications such as the ones described above.

# 11. Basic Facts for nRF52 Chip

Below chart shows basic spec for Nordic nRF52 family, which is helpful to understand the differences between each SoC. Any discrepancy shall refer to Nordic's technical document as final reference.

See [Full List of Raytac's BLE Modules](#) for complete model no. of each item.

Nordic Solution	nRF52840	nRF52833	nRF52820	nRF52832	nRF52810	nRF52811	nRF52805
RAYTAC Model No. (MDBTXX)	50Q series	50Q series 50 series	50 series	42Q series 42 series 42V series	42Q series	42Q Series	42T series 42TV series
Bluetooth Direction Finding		V	V			V	
Bluetooth 5 Long Range (125kbps)	V	V	V			V	
Bluetooth 5 High Speed	V	V	V	V	V	V	V
Bluetooth 5 Ad. Extention (x8)	V	V	V	V	V	V	V
Flash (kBytes)	1024	512	256	512	192	192	192
RAM (kBytes)	256	128	32	64	24	24	24
ANT Plus	V	V	V	V	V	V	
IEEE 802.15.4	V	V	V			V	
ARM® TrustZone® Cryptocell	V						
USB	V	V	V				
QSPI	V						
NFC	V	V		V			
I2S	V	V		V			
SPI, TWI, UART, PWM	V	V	V	V	V	V	without PWM
PDM	V	V		V	V	V	
ADC, Comparators	V	V	without ADC	V	V	V	without comparators
Supply Range (V)	1.7 to 5.5	1.7 to 5.5	1.7 to 5.5	1.7 to 3.6	1.7 to 3.6	1.7 to 3.6	1.7 to 3.6

## 12. Useful Links

- **Nordic Infocenter:** <https://infocenter.nordicsemi.com/index.jsp>  
All the necessary technical files and software development kits of Nordic's chip are on this website.
- **Nordic DevZone:** <https://devzone.nordicsemi.com/questions/>  
A highly recommended website for firmware developers. Interact, discuss and consult with other fellow developers and Nordic's employees to get answers to your questions. The site also includes tutorials in detail to help you get started.
- **Official Page of nRF52832 :**  
<https://www.nordicsemi.com/eng/Products/Bluetooth-low-energy/nRF52832>  
A brief introduction to nRF52832 and download links for Nordic's developing software and SoftDevices.

# Full List of Raytac's BLE Modules

## ● MDBT40 Series

Series	Nordic Solution	Raytac No.	IC Ver.	Antenna	RAM	Flash Memory
MDBT40	nRF51822	MDBT40-256V3	3	Chip Antenna	16 kb	256 K
		MDBT40-256RV3			32 kb	256 K
MDBT40-P	nRF51822	MDBT40-P256V3	3	PCB Antenna	16 kb	256 K
		MDBT40-P256RV3			32 kb	256 K

## ● MDBT42Q Series (QFN Package IC)

Series	Nordic Solution	Raytac No.	IC Ver.	Antenna	RAM	Flash Memory
MDBT42Q	nRF52832	MDBT42Q-512KV2	2	Chip Antenna	64 kb	512 K
	nRF52810	MDBT42Q-192KV2	2		24 kb	192 K
	nRF52811	MDBT42Q-192KL	1			
MDBT42Q-P	nRF52832	MDBT42Q-P512KV2	2	PCB Antenna	64 kb	512 K
	nRF52810	MDBT42Q-P192KV2	2		24 kb	192 K
	nRF52811	MDBT42Q-P192KL	1			
MDBT42Q-U	nRF52832	MDBT42Q-U512KV2	2	u.FL Connector	64 kb	512 K

## ● MDBT42 Series (WLCSP Package IC)

Series	Nordic Solution	Raytac No.	IC Ver.	Antenna	RAM	Flash Memory
MDBT42	nRF52832	MDBT42-512KV2	2	Chip Antenna	64 kb	512 K
MDBT42-P		MDBT42-P512KV2		PCB Antenna		

## ● MDBT42V Series (WLCSP Package IC)

Series	Nordic Solution	Raytac No.	IC Ver.	Antenna	RAM	Flash Memory
MDBT42V	nRF52832	MDBT42V-512KV2	2	Chip Antenna	64 kb	512 K
MDBT42V-P		MDBT42V-P512KV2		PCB Antenna		

## ● MDBT42T Series (WLCSP Package IC)

Series	Nordic Solution	Raytac No.	IC Ver.	Antenna	RAM	Flash Memory
MDBT42T	nRF52805	MDBT42T-192K	1	Chip Antenna	24 kb	192 K
MDBT42T-P		MDBT42T-P192K		PCB Antenna		

## ● MDBT42TV Series (WLCSP Package IC)

Series	Nordic Solution	Raytac No.	IC Ver.	Antenna	RAM	Flash Memory
MDBT42TV	nRF52805	MDBT42TV-192K	1	Chip Antenna	24 kb	192 K
MDBT42TV-P		MDBT42TV-P192K		PCB Antenna		



## ● MDBT50Q Series (aQFN Package IC)

Series	Nordic Solution	Raytac No.	IC Ver.	Antenna	RAM	Flash Memory
MDBT50Q	nRF52840	MDBT50Q-1MV2	2	Chip Antenna	256 kb	1 MB
	nRF52833	MDBT50Q-512K	1		128 kb	512 kb
MDBT50Q-P	nRF52840	MDBT50Q-P1MV2	2	PCB Antenna	256 kb	1 MB
	nRF52833	MDBT50Q-P512K	1		128 kb	512 kb
MDBT50Q-U	nRF52840	MDBT50Q-U1MV2	2	u.FL Connector	256 kb	1 MB
	nRF52833	MDBT50Q-U512K	1		128 kb	512 kb
Dongle	nRF52840	MDBT50Q-RX	1, 2	PCB Antenna	256 kb	1 MB

## ● MDBT50 Series (QFN Package IC)

Series	Nordic Solution	Raytac No.	IC Ver.	Antenna	RAM	Flash Memory
MDBT50	nRF52820	MDBT50-256R	1	Chip Antenna	32 kb	256 kb
	nRF52833	MDBT50-512K	1		128 kb	512 kb
MDBT50-P	nRF52820	MDBT50-P256R	1	PCB Antenna	32 kb	256 kb
	nRF52833	MDBT50-P512K	1		128 kb	512 kb

## ● MDBT53 Series (WLCSP Package IC)

Series	Nordic Solution	Raytac No.	IC Ver.	Antenna	RAM	Flash Memory
MDBT53	nRF5340	MDBT53-1M	1	Chip Antenna	512 kb	1 MB
MDBT53-P	nRF5340	MDBT53-P1M	1	PCB Antenna	512 kb	1 MB
MDBT53-U	nRF5340	MDBT53-U1M	1	u.FL Connector	512 kb	1 MB

## ● MDBT53V Series (WLCSP Package IC)

Series	Nordic Solution	Raytac No.	IC Ver.	Antenna	RAM	Flash Memory
MDBT53V	nRF5340	MDBT53V-1M	1	Chip Antenna	512 kb	1 MB
MDBT53V-P	nRF5340	MDBT53V-P1M	1	PCB Antenna	512 kb	1 MB

# Release Note

- 2017/05/05 Version A: 1<sup>st</sup> release
  
- 2017/10/06 Version B
  - (1) Update Chapter 2.3, Chapter 4 and list of model no.
  - (2) Added Chapter 7 (antenna info), Chapter 9 (certificates info), Chapter 10 (Basic Facts for nRF52 Chip).
  
- 2018/04/16 Version C
  - (1) Updated model no. to MDBT42V-512KV2 and MDBT42V-P512KV2 for V2 IC and Chapter 4 and list of model no.
  - (2) Added Chapter 10 (Notes and Cautions) and Chapter 12 (Useful Links).
  
- 2019/01/03 Version D
  - (1) Updated link of footprint in Chapter 2.
  - (2) Added tray info in Chapter 4.
  - (3) Refined description of default setting in Chapter 8.
  - (4) Added CE EN300 328 (RED) compliant proof and updated link for RoHS & REACH reports in Chapter 9.
  - (5) Added “no washing” warning in Chapter 10.
  - (6) Added link of Documentation Library in Chapter 12.
  - (7) Added new item “MDBT50Q-RX” in full list of Raytac’s model no.
  
- 2019/08/06 Version E
  - (1) Updated table of supported Profile & Service Information in Chapter 1: Overall Introduction.
  - (2) Added tolerance of PCB size in Chapter 2: Product Dimension.
  - (3) Refined description for RF Layout Suggestion.
  - (4) Corrected model no. and updated information of tray packaging in Chapter 4: Shipment Packaging Information.
  - (5) Updated description of test code in Chapter 8: Reference Circuit.
  - (6) Added nRF52811 information in Chapter 11: Basic Facts for nRF52 Chip.
  - (7) Removed link of Documentation Library in Chapter 12: Useful Links.

(8) Updated Full List of Raytac's BLE Modules.

- 2019/12/20 Version F

- (1) Updated GPIO table in section 6 of Chapter 2: Product Dimension.

- (2) Updated marking information on the shield in Chapter 4: Shipment Packaging Information.

- (3) Updated Declaration ID information and integrated section 3 of Chapter 1 into section 1 of Chapter 9: Certification.

- (4) Added nRF52833 to the chart in Chapter 11: Basic Facts of nRF52 Family & Full List of Raytac's BLE Modules.

- 2020/06/12 Version G

- (1) Updated CE reports to EN300.328 V2.2.2 & EN62368-1.

- (2) Added nRF52820 in Chapter 11: Basic Facts of nRF52 Family.

- (3) Updated Full List of Raytac's BLE modules.

- 2021/01/07 Version H

- (1) Added information T&R, order code and label contexts in Chapter 4: Shipment Packaging Information

- (2) Added BT 5.2 SIG approval & KC Certificate in Chapter 9: Certification.

- (3) Updated table in Chapter 11: Basic Facts for nRF52 Family.

- (4) Updated Full List of Raytac's BLE Modules.

- 2021/07/16 Version I

- (1) Updated graph in section 2 of Chapter 2: Product Dimension.

- (2) Updated information of tray packaging in Chapter 4: Shipment Packaging Information.

- 2022/10/11 Version J

- (1) Updated SRRC certificate.

- (2) Updated Chapter 4: 4.2.2 Tape & Reel Packaging info.

- (3) Updated Chapter 2: 2.3 RF Layout Suggestion (aka Keep-Out Area).

- (4) Updated Full List of Raytac's BLE modules.

(5) Updated Chapter 5: Specification corresponding to Nordic's new nRF52832 Product Specification V1.8.

- 2022/12/20 Version K

(1) Updated PCB Pin Indication picture in Chapter 2: Product Dimension.

- 2023/07/12 Version L

(1) Updated drawing in Chapter 2 for a better understanding of PCB measurement & RF Layout Suggestion.

