

## Built-in Antenna Bluetooth 5.1 Module

### Multi-Protocol, Long Range & Direction Finding

This last generation BLE module is deployed in 2 variants to support complex or baseline applications requiring Bluetooth 5.1 standard for Long Range and Direction-Finding connectivity. At 8 x 8 x 1 mm, ISP1907 series provide huge computing capability coupled with best-in-class battery life, making this Bluetooth Low Energy / BLE module a ready to use solution for most of IOT applications.

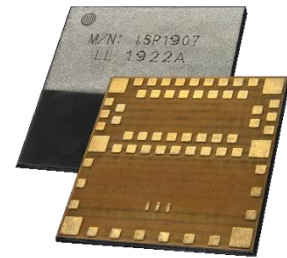

### Common Key Features

- Bluetooth 5.1 long-range direction-finding
- Thread / Zigbee / ANT+ stacks available
- Multi-protocol 2.4GHz low energy RF transceiver from nRF52 Nordic Semi family
- 32-bit ARM Cortex M4 CPU
- Many analog and digital IOs including ADC, SPI, UART, PDM, I2C
- Fully integrated RF matching and Antenna
- Embedded 32 MHz Radio & 32 kHz Synchro
- DC/DC converter including inductor
- Pin compatibility with iSP15, 18 & 19 series
- Single 1.7 to 3.6 V supply
- Very small size 8.0 x 8.0 x 1.0 mm

### Certifications

- Bluetooth SIG listing
- Radio CE, FCC, IC, TELEC, KCC
- RoHS2, REACH, Conflict Minerals

### LL Variant

- 192 kB Flash & 24 kB SRAM
- 13 Configurable GPIOs including 3 ADCs

### HT Variant

- NFC-A Tag for OOB pairing
- ARM Cortex M4F Floating Point processor
- 512 kB Flash & 128 kB SRAM
- 30 Configurable GPIOs including 8 ADCs
- USB interface

### Applications

- Connected sensors for medical devices, healthcare, sport, fitness, industrial ...
- IoT applications, connected objects
- Wearable technology
- Home automation
- Beacons

## Revision History

Revision	Date	Ref	Change Description
R0	26/06/2019	cr pg	Preliminary release
R1	10/01/2020	ys pg	Section 3 – HT variant pin description update
R2	28/01/2020	ys pg	Section 3 – Trace Data port added to HT variant
R3	03/03/2020	ys pg	Section 2 – HT variant schematic and specifications
R4	23/04/2020	ys pg	Section 2 – HT variant schematic update
R5	05/05/2021	cb pg	Section 8 – Certification list update
R6	29/04/2022	pd pg	Document layout update
R7	16/09/2022	pd pg	Section 8 – Certification list update
R8	30/11/2022	er pg	Certification update
R9	12/04/2023	mm pg	Packaging information update
R10	30/08/2023	er pg	Maximum Rating and Power Consumption updates
R11	11/03/2024	pg pg	Certification update

## Contents

---

<b>1.</b>	<b>Block Diagram</b> .....	<b>4</b>
<b>2.</b>	<b>Specifications</b> .....	<b>5</b>
2.1.	General Notice.....	5
2.2.	Absolute Maximum Ratings.....	5
2.3.	Operating Conditions.....	5
2.4.	Power Consumption.....	6
2.5.	Clock Sources.....	6
2.6.	Radio Specifications.....	6
2.7.	Electrical Schematic.....	9
<b>3.</b>	<b>Pin Description</b> .....	<b>11</b>
<b>4.</b>	<b>Mechanical Outlines</b> .....	<b>14</b>
4.1.	Mechanical Dimensions.....	14
4.2.	SMT Assembly Guidelines.....	14
4.3.	Antenna Keep-Out Zone.....	15
<b>5.</b>	<b>Product Development Tools</b> .....	<b>16</b>
5.1.	Hardware.....	16
5.2.	Firmware.....	16
5.3.	Development Tools.....	17
<b>6.</b>	<b>Packaging &amp; Ordering information</b> .....	<b>18</b>
6.1.	Module Marking.....	18
6.2.	Package Labelling.....	18
6.3.	Prototype Packaging.....	19
6.4.	Jedec Trays.....	19
6.5.	Tape and Reel.....	20
6.6.	Ordering Information.....	21
<b>7.</b>	<b>Storage &amp; Soldering information</b> .....	<b>22</b>
7.1.	Storage and Handling.....	22
7.2.	Moisture Sensitivity.....	22
7.3.	Soldering information.....	23
<b>8.</b>	<b>Quality &amp; User information</b> .....	<b>24</b>
8.1.	Certifications.....	24
8.2.	USA – User information.....	24
8.3.	Canada – User information.....	24
8.4.	RF Exposure Information.....	25
8.5.	Informations concernant l'exposition aux fréquences radio (RF).....	25
8.6.	Discontinuity.....	25
8.7.	Disclaimer.....	26

## 1. Block Diagram

This module is based on nRF52 Nordic Semiconductor 2.4GHz wireless System on Chip (SoC) integrating a 2.4 GHz transceiver, a 32-bit ARM Cortex™-M4 CPU, either 512 kB or 192 kB flash memory, either 128 kB RAM or 24 kB RAM and analog and digital peripherals.

It can support BLE, ANT/ANT+, Thread, Zigbee and a range of proprietary 2.4 GHz protocols, such as Gazell from Nordic Semiconductor.

Fully qualified BLE stacks for nRF52 are implemented in the S112/S132 SoftDevices which can be freely downloaded. ISP1907 can then be used in Central, Peripheral or both roles for BLE and for both ends of other proprietary protocols. nRF52 platform also provides extensive software support for Zigbee and Thread applications with nRF5 SDK, for ANT applications with S212/S312 SoftDevices.

Ultra-low power consumption and advanced power management enables battery lifetimes up to several years on a coin cell battery. Despite its very small size 8 x 8 x 1.0 mm, the module integrates decoupling capacitors, 32 MHz and 32.768 kHz crystals, DC-DC converter including the large inductor, RF matching circuit and antenna in addition to the wireless SoC.

Only the addition of a suitable DC power source is necessary for low energy connectivity. Sensor applications require the further addition of appropriate sensors. The antenna was designed to be optimized with several standard ground plane sizes. When NFC function is available, the NFC tag antenna can be connected externally.

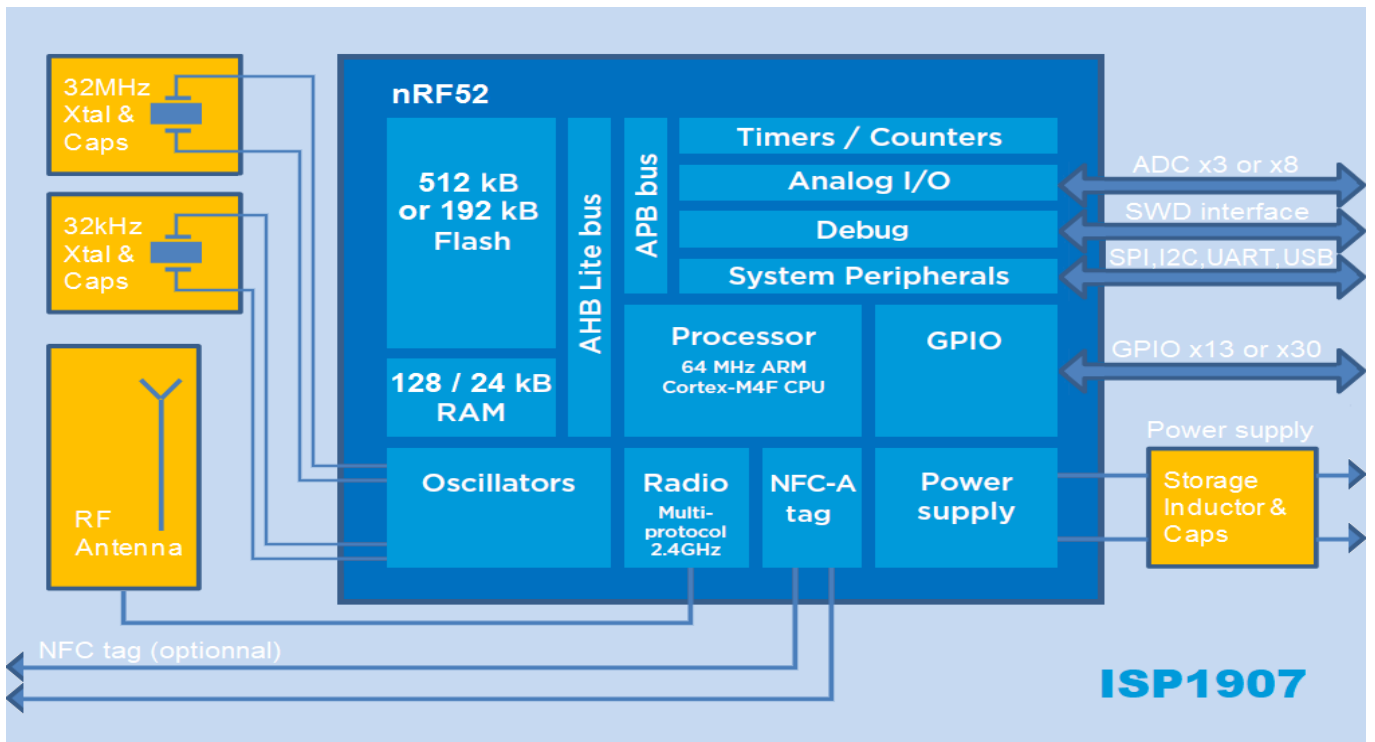

## 2. Specifications

### 2.1. General Notice

The electrical specifications of the module are directly related to the Nordic Semiconductor specifications for nRF52 chipset series. The information below is only a summary of the main parameters. For more detailed information, especially about current consumption, please refer to the up-to-date specification of the chipset available on Nordic Semi website.

### 2.2. Absolute Maximum Ratings

Parameter	Min	Typ	Max	Unit
Main Supply Voltage respect to ground – VCC_nRF	-0.3		3.9	V
USB Supply Voltage respect to ground - VBUS	-0.3		5.8	V
IO Pin Voltage	-0.3		3.9	V
RF Input Level			10	dBm
NFC Antenna pin current			80	mA
Module Total Capacity			2.5	μF
Module Total Inductance			15	μH
Storage Temperature	-40		+125	°C
Moisture Sensitivity Level			3	-
ESD Human Body Model – ISP1907-HT			HT: 4000 LL: 2000	V
ESD Charged Device Model – ISP1907-HT			HT: 750 LL: 1000	V
Flash Endurance			10000	cycles

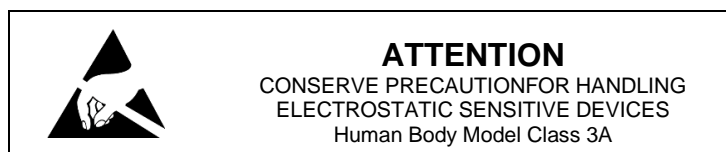

### 2.3. Operating Conditions

Parameter	Min	Typ	Max	Unit
VCC_nRF Supply Voltage, independent of DCDC enable	1.7	3.0	3.6	V
VBUS Supply Voltage	4.35	5.0	5.5	V
Operating Temperature Range – LL Variant	-40	+25	+85	°C
Operating Temperature Range – HT Variant only	-40	+25	+105	°C

## 2.4. Power Consumption

Parameter	Typ / LL variant	Typ / HT variant	Unit
Radio current, Receiver active <sup>(1)</sup>	6.1	6	mA
Radio current, Transmitter active -40 dBm Output Power <sup>(1)</sup>	3.4	3.5	mA
Peak current, Transmitter active 0 dBm Output Power <sup>(1)</sup>	5.8	6.1	mA
System OFF, no RAM retention, wake on reset	0.3	0.6	µA
System ON, full RAM retention, wake on any event	0.8	1.8	µA

(1) DCDC enable, Power supply 3V, 1 Mbps

## 2.5. Clock Sources

Parameter	Max	Unit
Internal High Frequency Clock for RF Stability: 32 MHz Crystal Frequency Tolerance <sup>(1)</sup>	+/- 40	ppm
Internal Low Frequency Clock for BLE Synchronization: 32.768 kHz Crystal Frequency Tolerance <sup>(1)</sup>	+/- 40	ppm
Internal Low Frequency Clock for BLE Synchronization: RC Oscillator <sup>(2)</sup>	+/- 500	ppm
RF Frequency tolerance: For BLE operation Channels0 to 39	+/- 40	ppm

(1) including initial tolerance, drift, aging, and frequency pulling

(2) Frequency tolerance after calibration

## 2.6. Radio Specifications

Parameter	Min	Typ	Max	Unit
Operating Frequencies	2360		2500	MHz
RF Channel spacing		1		MHz
Data Rate	125		2000	kbps
RF Output Power, LL variant	-20		+4	dBm
RF Output Power, HT variant	-20		+8	dBm
Rx sensitivity Level 1 Mbps BLE mode, ideal Tx		-94		dBm
Rx sensitivity Level 125 kbps Long Range mode, ideal Tx		-104		dBm
Antenna Gain		0.6		dBi
Range Open field, BLE mode @1m height		100		m
Range Open field, Long Range mode +4 dBm @1m height		400		m

**Typical Antenna Return Loss**

Module mounted on a USB dongle ground plane

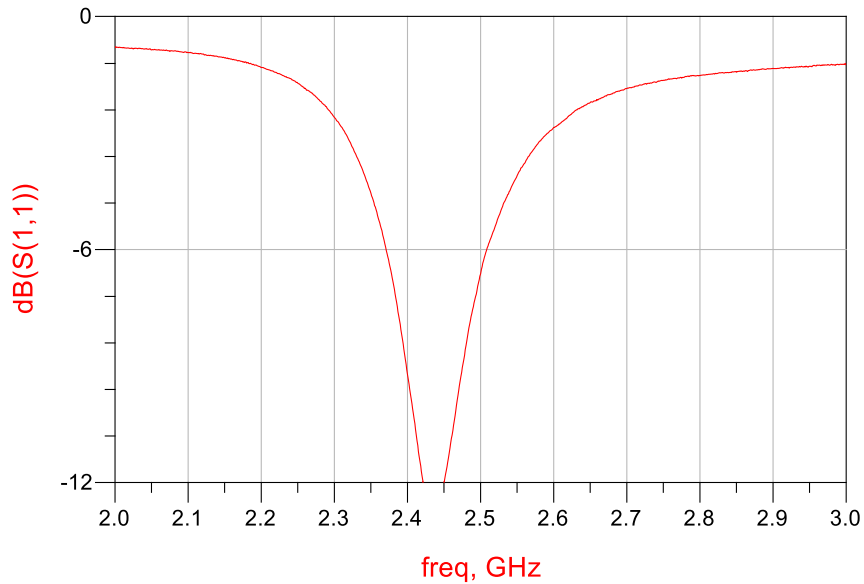

**Radiation Pattern in 3 planes**

Module mounted on a USB dongle ground plane

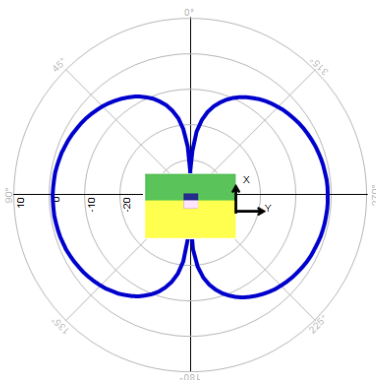
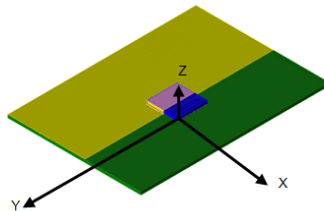

Phi (0.000 to 360.000)

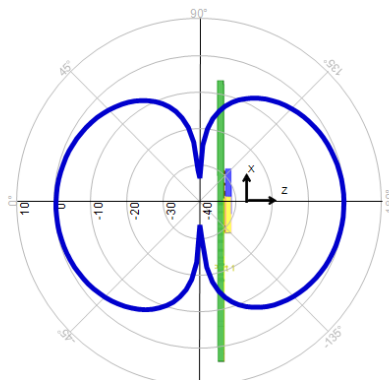

Thêta (-180.000 to 180.000)

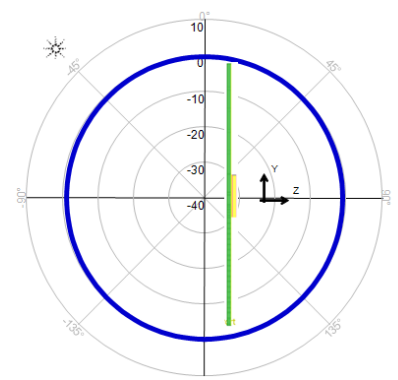

Thêta (-180.000 to 180.000)

Gain measurement in dBi @ 2.45 GHz.

**Ground Plane Effect Simulation**

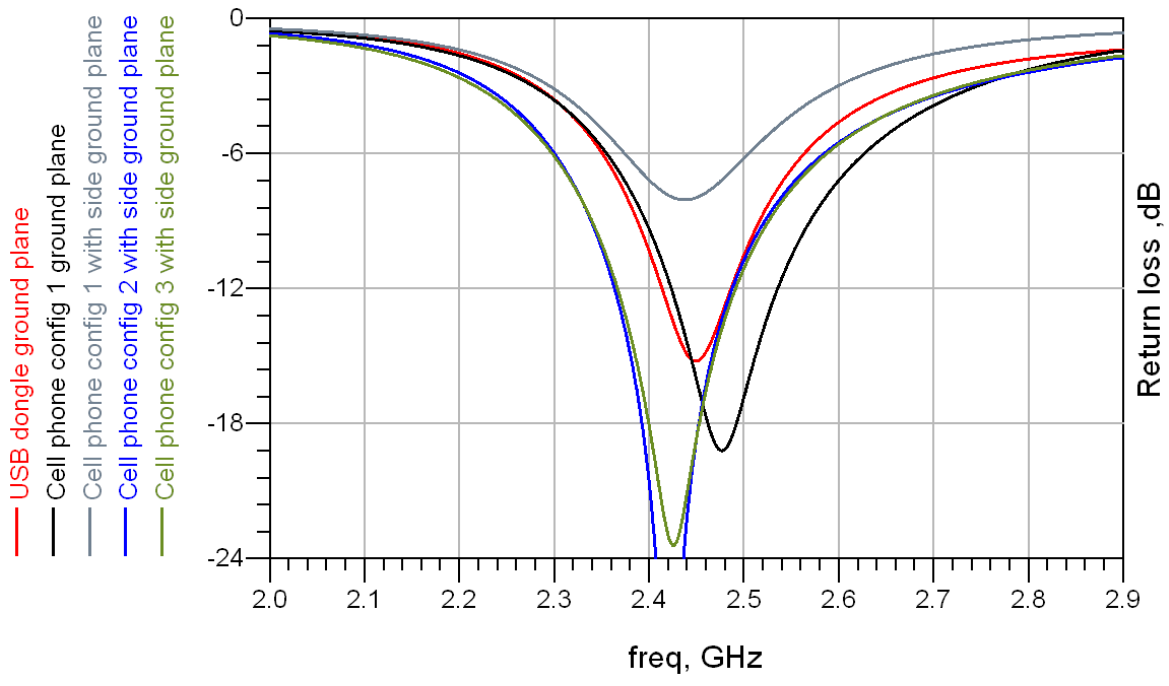
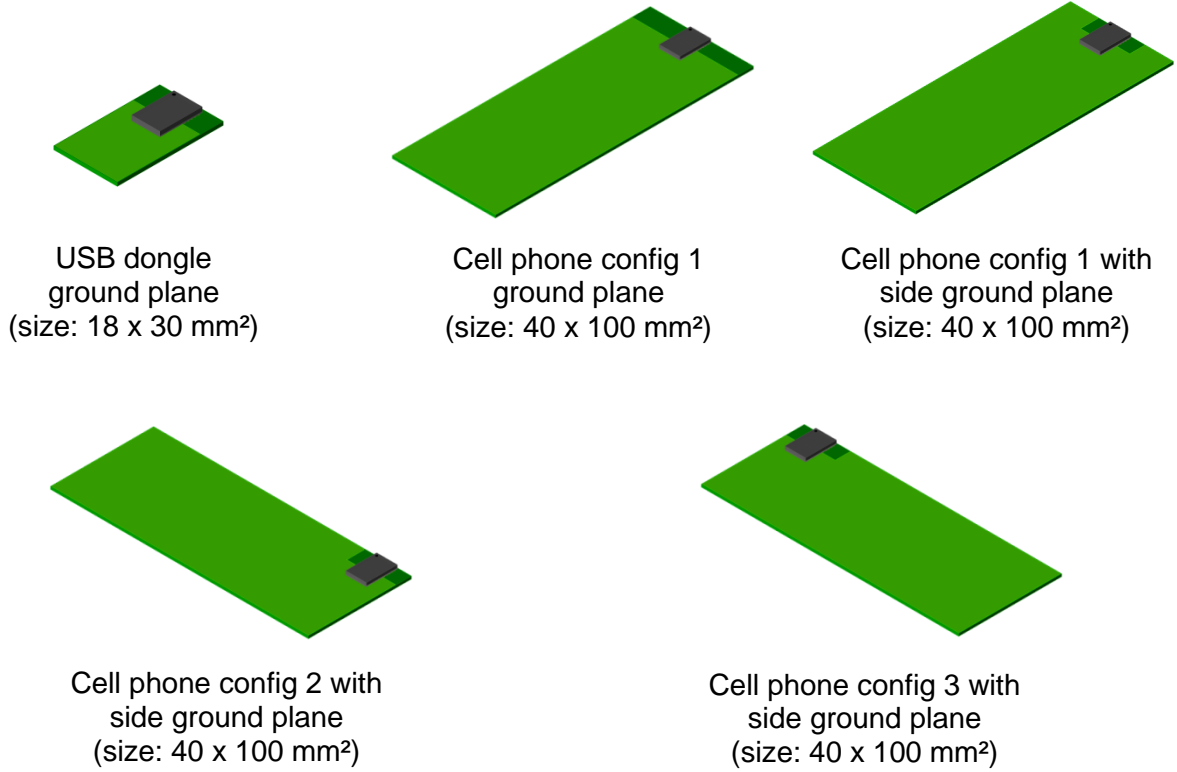



**2.7. Electrical Schematic**

**LL variant**

Hereafter electrical schematic is showing ISP1907-LL module connections. For further information on electrical performance, please note that LL variant is based on nRF52811 chipset.

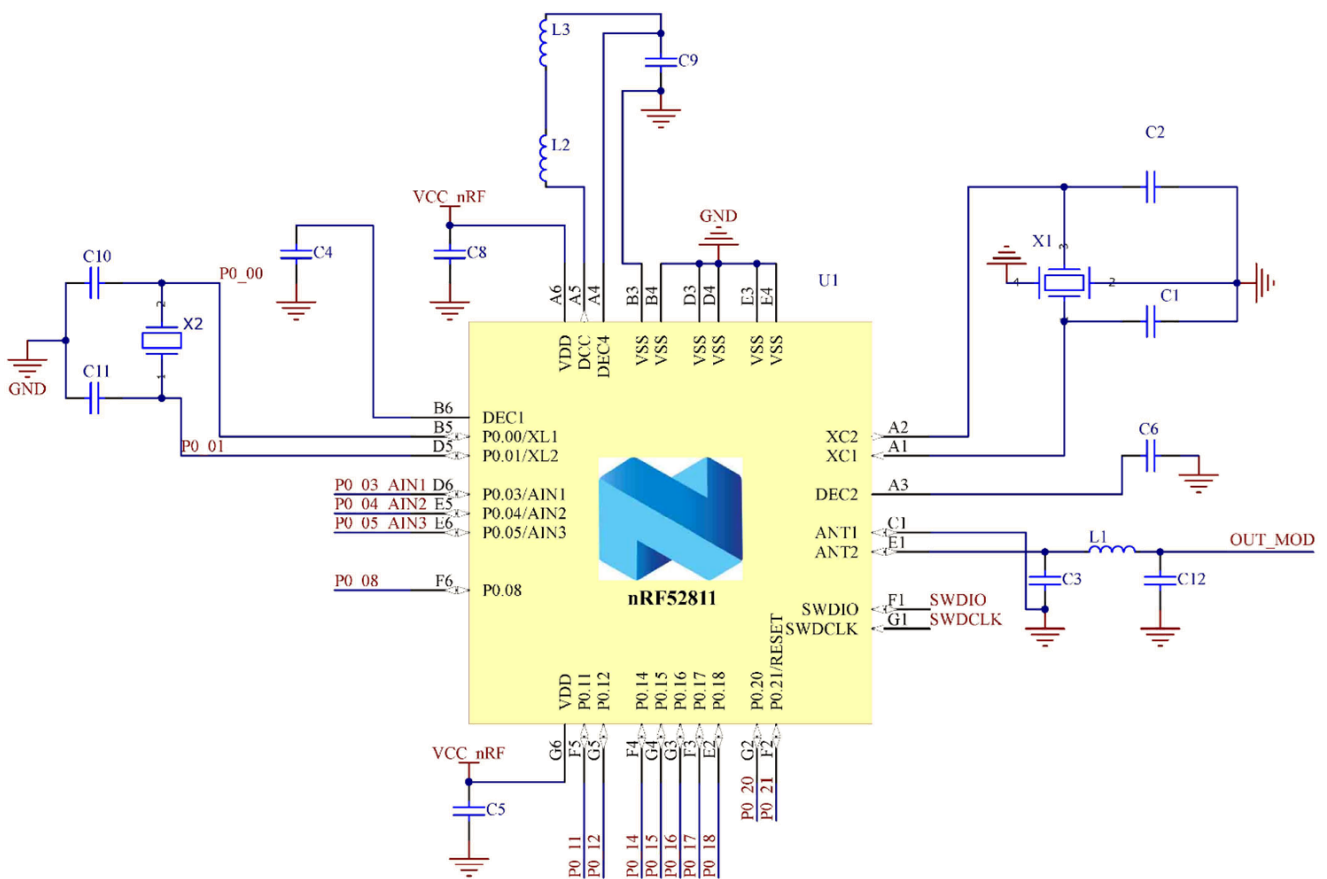



### 3. Pin Description

The module uses an LGA format with multiple rows of pads on a 0.65 mm pitch. The pad layout follows the QFN Jedec standard for 2 row LGA parts. The NC pads are to be connected to isolated metal pads on the application PCB for mechanical stability and reliability (drop test).

Pin	Description for LL variant		Description for HT variant	
1	VSS	Must be connected to ground	VSS	Must be connected to ground
2	P0_12	General purpose I/O pin	P0_09 NFC1	General purpose I/O pin NFC antenna connection
3	NC	Isolated pad	P0_12 TRACEDATA1	General purpose I/O pin Trace port output
4	P0_14 TRACEDATA3	General purpose I/O pin Trace port output	P0_10 NFC2	General purpose I/O pin NFC antenna connection
5	NC	Isolated pad	P0_14	General purpose I/O pin
6	P0_18 TRACEDATA0	General purpose I/O pin Trace port output	P0_26	General purpose I/O pin
7	VSS	Must be connected to ground	VSS	Should be connected to ground plane on application PCB
8	VSS	Must be connected to ground	D+	USB D+
9	P0_16 TRACEDATA1	General purpose I/O pin Trace port output	P0_16	General purpose I/O pin
10	VSS	Must be connected to ground	D-	USB D-
11	NC	Isolated pad	P0_21	General purpose I/O pin
12	VSS	Must be connected to ground	VBUS	5V input for USB 3.3V regulator
13	P0_21 RESET	General purpose I/O pin Configurable as system RESET pin	P0_18 RESET	General purpose I/O pin Configurable as system RESET pin
14	VSS	Must be connected to ground	VSS	Must be connected to ground
15	NC	Isolated pad	P0_20	General purpose I/O pin
16	VSS	Must be connected to ground	VSS	Should be connected to ground plane on application PCB
17	NC	Isolated pad	P1_00 TRACEDATA0	General purpose I/O pin Trace port output
18	VSS	Must be connected to ground	VSS	Should be connected to ground plane on application PCB
19	P0_20 TRACECLK	General purpose I/O pin Trace port clock output	P0_24	General purpose I/O pin
20	OUT_ANT	This pin is connected to the internal antenna It should be connected to Pin 22 OUT_MOD for normal operation	OUT_ANT	This pin is connected to the internal antenna It should be connected to Pin 22 OUT_MOD for normal operation
21	VSS	Must be connected to ground	VSS	Must be connected to ground
22	OUT_MOD	This pin is the RF I/O pin of the BLE module It should be connected to Pin 20 OUT_ANT for normal operation	OUT_MOD	This pin is the RF I/O pin of the BLE module It should be connected to Pin 20 OUT_ANT for normal operation
23	VSS	Must be connected to ground	VSS	Must be connected to ground
24	VSS	Must be connected to ground	VSS	Must be connected to ground
25	VSS	Must be connected to ground	VSS	Must be connected to ground

Pin	Description for LL variant		Description for HT variant	
26	VCC_nRF	Power supply (1.7 – 3.6V)	VCC_nRF	Power supply (1.7 – 3.6V)
27	NC	Isolated pad	P0_17	General purpose I/O pin
28	SWDIO	Serial Wire Debug I/O for debug and programming	SWDIO	Serial Wire Debug I/O for debug and programming
29	NC	Isolated pad	P0_13	General purpose I/O pin
30	SWDCLK	Serial Wire Debug clock input for debug and programming	SWDCLK	Serial Wire Debug clock input for debug and programming
31	VSS	Must be connected to ground	VSS	Must be connected to ground
32	P0_08	General purpose I/O pin	P0_08	General purpose I/O pin
33	NC	Isolated pad	P0_07 TRACECLK	General purpose I/O pin Trace port clock output
34	P0_17	General purpose I/O pin	P0_06	General purpose I/O pin
35	NC	Isolated pad	P0_04 AIN2	General purpose I/O pin SAADC/COMP/LPCOMP input
36	P0_05 AIN3	General purpose I/O pin SAADC/COMP/LPCOMP input	P0_05 AIN3	General purpose I/O pin SAADC/COMP/LPCOMP input
37	NC	Isolated pad	P1_09 TRACEDATA3	General purpose I/O pin Trace port output
38	P0_03 AIN1	General purpose I/O pin SAADC/COMP/LPCOMP input	P0_03 AIN1	General purpose I/O pin SAADC/COMP/LPCOMP input
39	NC	Isolated pad	P0_27	General purpose I/O pin
40	P0_01 XL2	Do not connect – Leave floating	P0_02 AIN0	General purpose I/O pin SAADC/COMP/LPCOMP input
41	NC	Isolated pad	P0_25	General purpose I/O pin
42	P0_00 XL1	Do not connect – Leave floating	P0_31 AIN7	General purpose I/O pin SAADC/COMP/LPCOMP input
43	NC	Isolated pad	P0_11 TRACEDATA2	General purpose I/O pin Trace port output
44	P0_15 TRACEDATA2	General purpose I/O pin Trace port output	P0_30 AIN6	General purpose I/O pin SAADC/COMP/LPCOMP input
45	NC	Isolated pad	P0_19	General purpose I/O pin
46	P0_04 AIN2	General purpose I/O pin SAADC/COMP/LPCOMP input	P0_29 AIN5	General purpose I/O pin SAADC/COMP/LPCOMP input
47	NC	Isolated pad	P0_23	General purpose I/O pin
48	P0_11	General purpose I/O pin	P0_28 AIN4	General purpose I/O pin SAADC/COMP/LPCOMP input
49 to 62	NC	Isolated pad	NC	Isolated pad

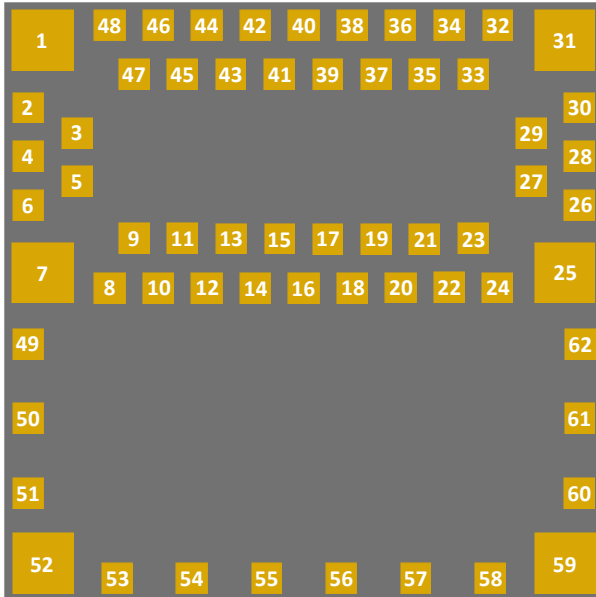

ISP1907  
62-pin LGA QFN package  
pad placement and pin assignment  
TOP VIEW

## 4. Mechanical Outlines

### 4.1. Mechanical Dimensions

Dimensional drawing for 8 x 8 x 1 mm, 62-Pad LGA Package

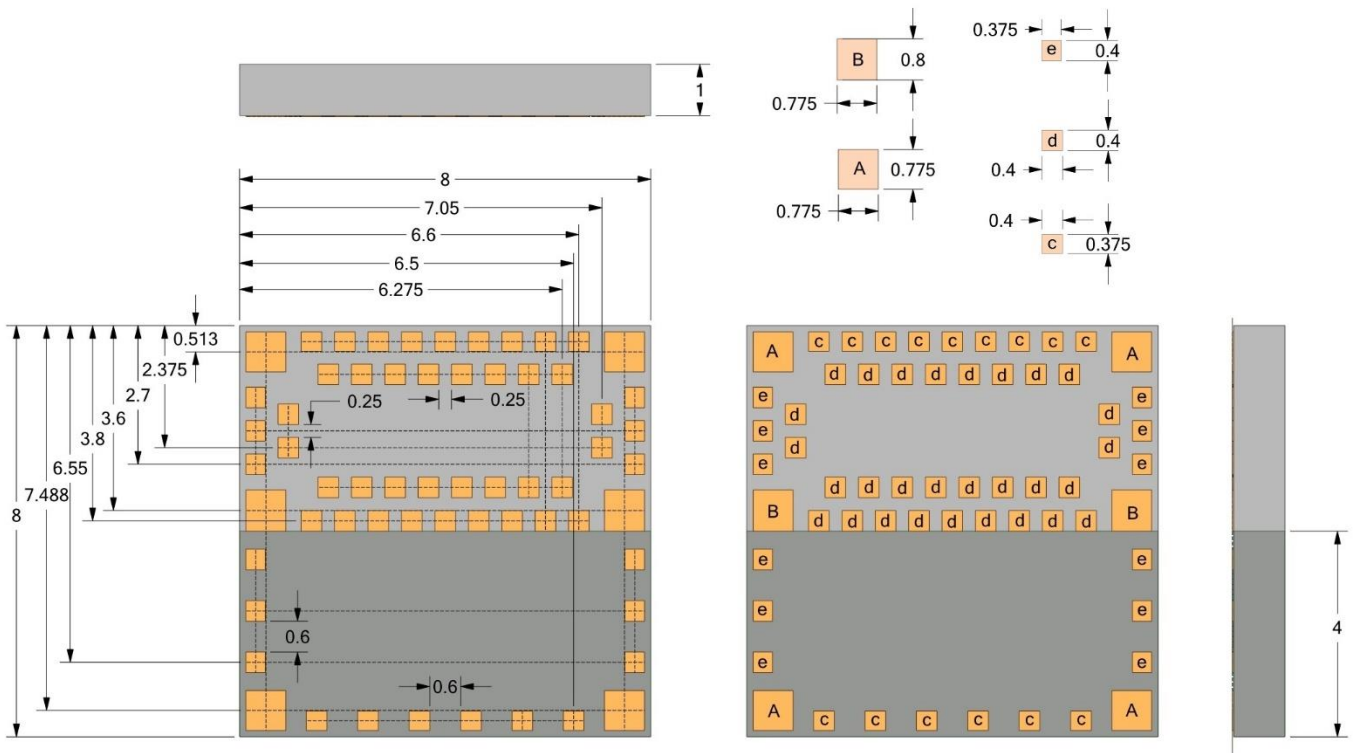

Dimensions in mm  
Tolerance : +/- 0.03 mm

### 4.2. SMT Assembly Guidelines

For PCB Land Patterns and Solder Mask layout, Insight SiP recommends using the same dimensions as module pads, ie 0.4 x 0.4 mm for standard pads and 0.8 x 0.8 mm for corner pads.

For implementations in which most or all of the inner pads are used Insight SiP recommends the use of capped vias placed in the centre of each pad.

For standard PCB types (no micro vias - all vias are top to bottom): we use nominal 0.4mm catch pads with 0.2mm vias. The vias should be plugged and capped to avoid solder wicking.

For HDI PCB types having micro vias on a layer by layer basis: we use 0.25mm catch pads and 0.1mm copper filled laser vias. Ideally the via is centered in the pad.

For reduced pinout implementations we recommend using external pads only. The use of a small number of internal pads can be accommodated by placing normal vias in the centre of the device. In this case only the required pads should be Solder Mask opened and the vias tented with solder mask to prevent short circuits.

Please contact Insight SiP for more detailed information.

### 4.3. Antenna Keep-Out Zone

For optimal antenna performance, it is recommended to respect a metal exclusion zone to the edge of the board: no metal, no traces and no components on any application PCB layer except mechanical LGA pads.

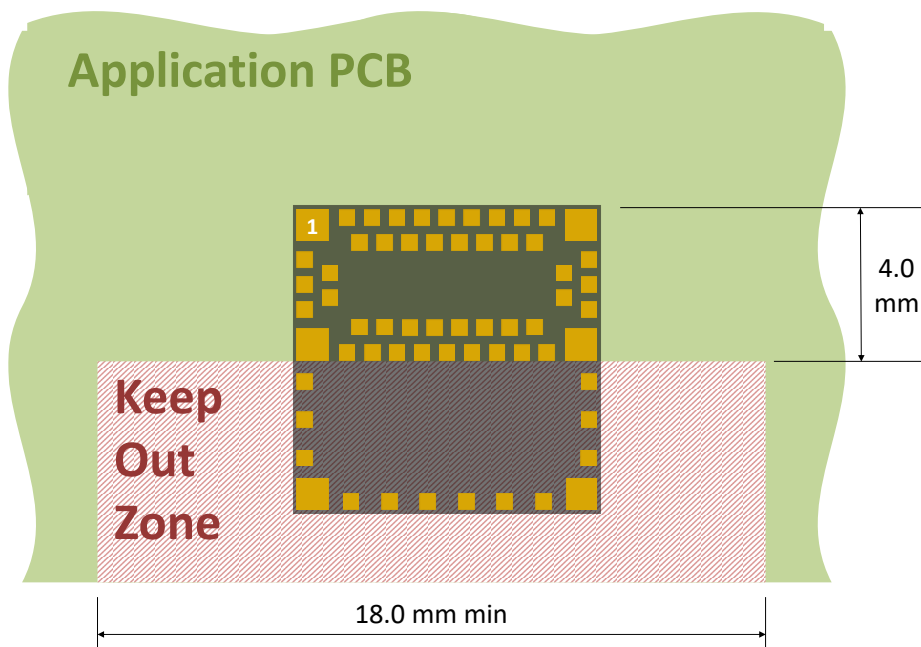

## 5. Product Development Tools

---

### 5.1. Hardware

In order to assist clients in developing their Bluetooth Smart solutions based on the ISP1907, Insight SiP offers an Evaluation Board containing:

- One Interface Board with J-Link Seeger integrated SWD/JTAG interface
- One Test Board
- Cables
- NFC Antenna (for the ISP1907-HT version)

Using this evaluation board, product developers can use a working solution as a starting point to develop their own products. Time to market is saved by avoiding starting from a blank sheet of paper.

Please refer to the documentation for more information:

[http://www.insightsip.com/fichiers\\_insightsip/pdf/ble/ISP1907/isp\\_ble\\_DS1907\\_DK.pdf](http://www.insightsip.com/fichiers_insightsip/pdf/ble/ISP1907/isp_ble_DS1907_DK.pdf)

### 5.2. Firmware

ISP1907 supports Bluetooth Low Energy protocol stacks, ANT protocol stacks as well as 2.4 GHz protocol stacks, including Gazell. For more details regarding SoftDevice stacks and their compatibility with ISP1907 module version, please refer to the Nordic info center at [www.infocenter.nordicsemi.com](http://www.infocenter.nordicsemi.com). All stacks can be downloaded at [www.nordicsemi.com](http://www.nordicsemi.com).

Even though any module version can support any stack, the S112 stack described hereunder is perfectly suited for ISP1907-LL version while S132, S212 and S332 are more dedicated to ISP1907-HT version.

- ✚ The S112 SoftDevice is a Bluetooth low energy peripheral protocol stack solution. It supports up to four peripheral connections with an additional broadcaster role running concurrently. The S112 SoftDevice integrates a Bluetooth low energy Controller and Host and provides a full and flexible API for building Bluetooth low energy ISP1907 solutions.
- ✚ The S132 SoftDevice is a Bluetooth low energy Central and Peripheral protocol stack solution. It supports up to twenty connections with an additional observer and a broadcaster role all running concurrently. The S132 SoftDevice integrates a Bluetooth low energy Controller and Host and provides a full and flexible API for building Bluetooth low energy ISP1907 solutions.
- ✚ The S212 SoftDevice is an ANT protocol stack solution that provides a full and flexible Application Programming Interface (API) for building ANT System on ISP1907 solutions. The S212 SoftDevice simplifies combining the ANT protocol stack and an application on the same CPU.
- ✚ The S332 SoftDevice is a combined ANT™ and Bluetooth low energy (BLE) protocol stack solution. It supports all four Bluetooth low energy roles (Central, Peripheral, Observer, Broadcaster) and ANT.



### 5.3. Development Tools

The following development tools and software are recommended for using and testing ISP1907 module:

- ✚ Nordic Semiconductor nRFgo Studio:  
Downloadable after registering at [www.nordicsemi.com](http://www.nordicsemi.com).
- ✚ Nordic Semiconductor Master Control Panel:  
Downloadable after registering at [www.nordicsemi.com](http://www.nordicsemi.com).  
An alternative remains to use the “nRF Connect” application for Smartphone available on the App Store (iOS device) and on the Play Store (Android device).
- ✚ Debugging and IDE:  
SEGGER Embedded Studio (SES):  
Downloadable from <https://www.segger.com/products/development-tools/embedded-studio/>  
  
Keil MDK-ARM Lite (limited to 32 KB code)  
Downloadable from <https://www.keil.com/demo/eval/arm.htm>.
- ✚ Segger J-Link Lite:  
Downloadable from <http://www.segger.com/jlink-software.html>.
- ✚ nRF52 Software Development Kit (SDK):  
nRF5-SDK can be downloaded after registering at [www.nordicsemi.com](http://www.nordicsemi.com). It contains example of source codes applications (C language):
  - Precompiled HEX files
  - Source code
  - SES project files
  - Keil ARM project files
  - IAR project files

## 6. Packaging & Ordering information

### 6.1. Module Marking

M	/N	:	I	S	P	1	9	0	7										
T	T		Y	Y	W	W	R		B	B	B	B	B	B	B	B	B	B	B

ISP1907	Part Number
TT	2 letters Module Type (see section 6.6)
YY	2 digits Year Number Date Code
WW	2 digits Week Number Date Code
R	1 letter Hardware Revision
BBBBBBBBBB	10 characters Build Code

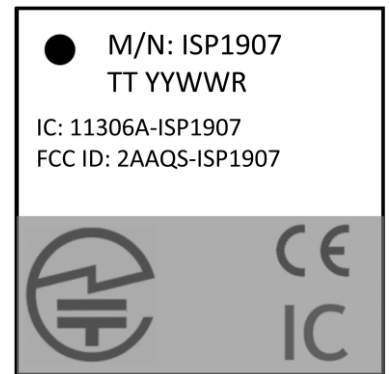

Certification labels for CE, FCC, IC and Telec are printed directly on the module when applicable.

### 6.2. Package Labelling

A label indicating the Module Part Number, Quantity, Date Code, Lot Code and Country of Origin is applied to the bag, the reel and the box, whichever is applicable.

Information is available with bar code 1D according to Code 39 and bar code 2D according to Data Matrix ECC 200 from ECIA standard.

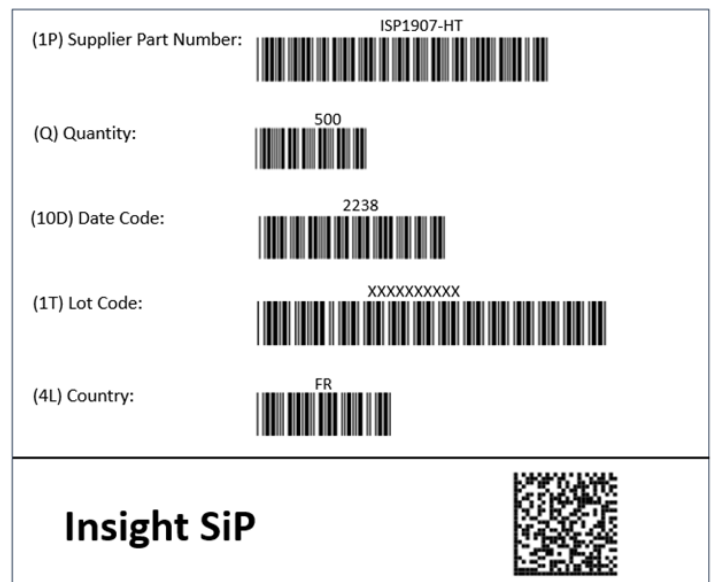

A second label on the bag is present to indicate the MSL level and packaging date.

	<b>CAUTION</b> This bag contains <b>MOISTURE SENSITIVE DEVICES</b>	<b>LEVEL</b> <b>3</b>
<ol style="list-style-type: none"><li>1. Calculated shelf life in sealed bag: 12 months at &lt;math&gt;&lt;40^{\circ}\text{C}&lt;/math&gt; and &lt;math&gt;&lt;90\%&lt;/math&gt; relative humidity (RH)</li><li>2. Peak package body temperature : <math&gt;260 -5^{\circ}\text{c}&lt;="" 0="" \pm="" li="" math&gt;<=""><li>3. After baking, devices that will be subject to reflow solder or other high temperature process must<ol style="list-style-type: none"><li>(i) Mounted within 168 hours of factory conditions &lt;math&gt;&lt;30^{\circ}\text{C}&lt;/math&gt; / 60% RH, or (ii) stored at &lt;math&gt;&lt;10\%&lt;/math&gt; RH</li></ol></li><li>4. Devices require bake, before mounting, if: a) Humidity Indicator Card reads &gt;10% for level 2a - 5a devices or &gt;60% for level 2 devices when read at <math&gt;23 3a="" 3b="" 5^{\circ}\text{c}&lt;="" \pm="" are="" b)="" li="" math&gt;="" met<="" not="" or=""><li>5. If baking is required, devices may be backed for 24 hours at <math&gt;125 5^{\circ}\text{c}&lt;="" \pm="" li="" math&gt;<=""></math&gt;125></li></math&gt;23></li></math&gt;260></li></ol>		
Bag Seal Date: _____		
Note: Level and body temperature defined by IPC/JEDEC J-STD-020		

### 6.3. Prototype Packaging

For engineering samples and prototype quantities up to 99 units, deliveries are provided in thermoformed trays.

They are delivered in vacuumed sealed pack with desiccant pack and humidity sensors. Please see section 7.2 for more information on moisture sensitivity.

Please order with “ST” code packaging suffix.



### 6.4. Jedec Trays

For pre-production volumes, ISP1907 are available in Jedec trays. They are delivered in vacuumed sealed pack with desiccant pack and humidity sensors. These Jedec trays are also suitable for further baking. Please see section 7.2 for more information on moisture sensitivity.

Please order with “JT” code packaging suffix.

Refer to tray sizes below. Complete information on Jedec trays is available on request.

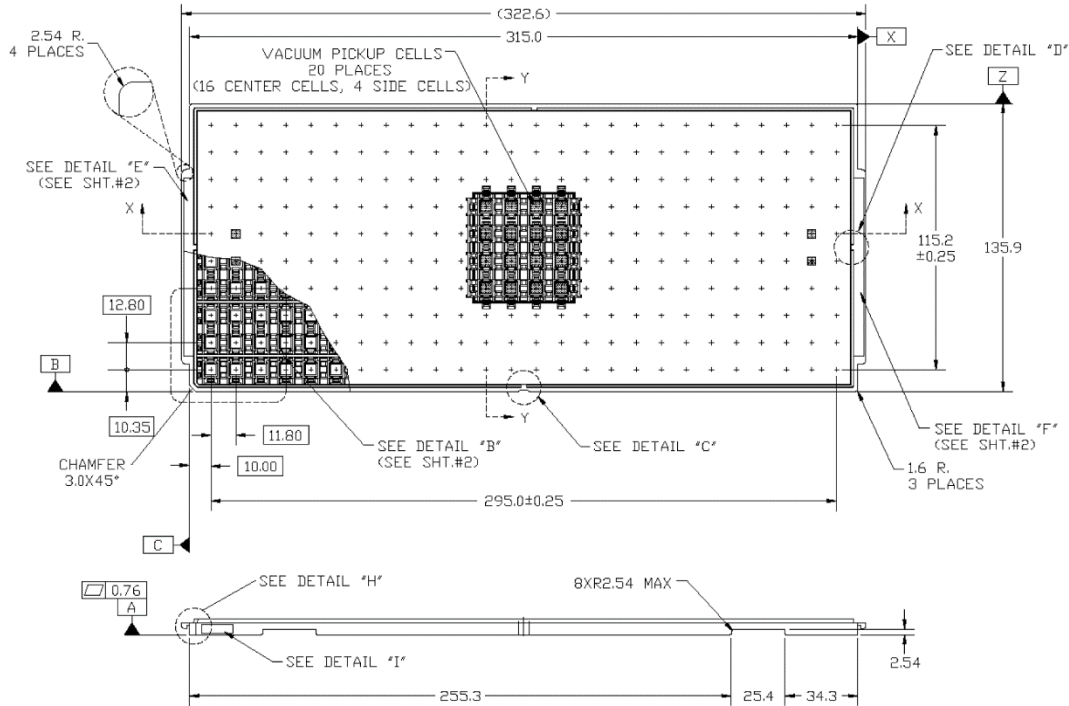

### 6.5. Tape and Reel

ISP1907 are also available in Tape & Reel. They are delivered in vacuumed sealed pack with desiccant pack and humidity sensors. Reels are proposed in standard quantities of 500 units (180mm / 7" reel).

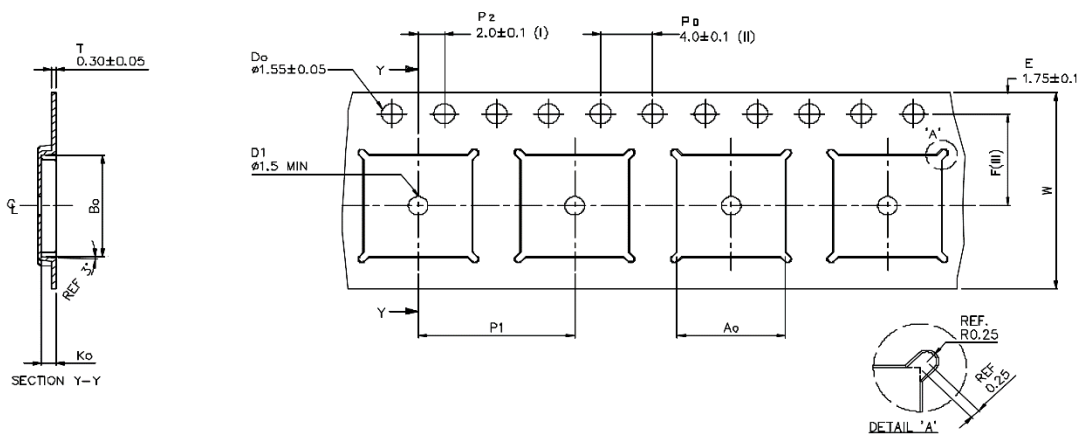

$A_o$	8.30 $\pm 0.1$
$B_o$	8.30 $\pm 0.1$
$K_o$	1.10 $\pm 0.1$
$F$	7.50 $\pm 0.1$
$P1$	12.00 $\pm 0.1$
$W$	16.00 $\pm 0.3$

- (I) Measured from centreline of sprocket hole to centreline of pocket.
  - (II) Cumulative tolerance of 10 sprocket holes is  $\pm 0.20$ .
  - (III) Measured from centreline of sprocket hole to centreline of pocket.
  - (IV) Other material available.
- ALL DIMENSIONS IN MILLIMETRES UNLESS OTHERWISE STATED.

Please order with “RS” code packaging suffix.

Reels are packed in a box of approximately 220 x 220 x 50 mm.



**6.6. Ordering Information**

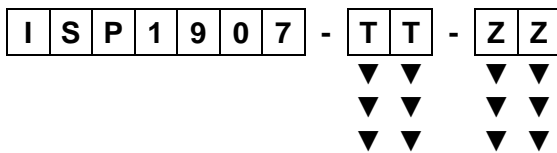

I S P 1 9 0 7

- L L  
- H T

- E B  
- T B  
- S T  
- J T  
- R S

Part Number

192 kB Flash / 24 kB RAM memory type  
512 kB Flash / 128 kB RAM memory type

Evaluation Board  
Test board  
Tray or Cut Tape  
Jedec Tray Packaging  
Reel of 500 units

## 7. Storage & Soldering information

---

### 7.1. Storage and Handling

- ✚ Keep this product away from other high frequency devices which may interfere with operation such as other transmitters and devices generating high frequencies.
- ✚ Do not expose the module to the following conditions:
  - Corrosive gasses such as Cl<sub>2</sub>, H<sub>2</sub>S, NH<sub>3</sub>, SO<sub>2</sub>, or NO<sub>X</sub>
  - Extreme humidity or salty air
  - Prolonged exposure to direct Sunlight
  - Temperatures beyond those specified for storage
- ✚ Do not apply mechanical stress
- ✚ Do not drop or shock the module
- ✚ Avoid static electricity, ESD and high voltage as these may damage the module

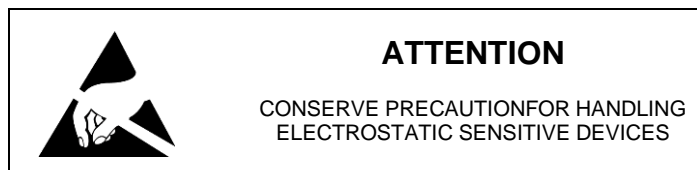

### 7.2. Moisture Sensitivity

All plastic packages absorb moisture. During typical solder reflow operations when SMDs are mounted onto a PCB, the entire PCB and device population are exposed to a rapid change in ambient temperature. Any absorbed moisture is quickly turned into superheated steam. This sudden change in vapor pressure can cause the package to swell. If the pressure exerted exceeds the flexural strength of the plastic mold compound, then it is possible to crack the package. Even if the package does not crack, interfacial delamination can occur.

Since the device package is sensitive to moisture absorption, it is recommended to bake the product before assembly. The baking process for dry packing is 24 hours at 125°C.

ISP1907 has been tested MSL-3 according to standards. After baking, modules can be exposed to ambient room conditions (approximately 30 °C/60%RH) during 168 hours before assembly on the PCB.



**7.3. Soldering information**

Recommendation for RoHS reflow process is according to Jedec J-STD-020 and 033 standard profiles.

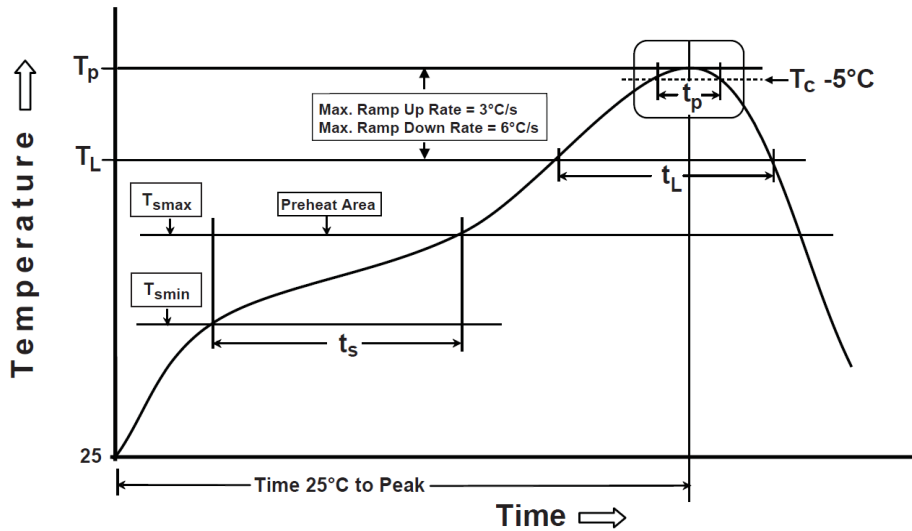

Preheat/Soak	
Temperature Min ( $T_{smin}$ )	150 °C
Temperature Max ( $T_{smax}$ )	200 °C
Time ( $t_s$ ) from ( $T_{smin}$ to $T_{smax}$ )	60-120 sec
Ramp-up rate ( $T_L$ to $T_p$ )	3 °C/sec max
Liquidous temperature ( $T_L$ )	217 °C
Time ( $t_L$ ) maintained above $T_L$	60-150 sec

Peak package body temperature ( $T_p$ )	260°C (+0/-5°C)
Classification Temperature ( $T_c$ )	260 °C
Time ( $t_p$ ) maintained above $T_c - 5$ °C	30 sec
Ramp-down rate ( $T_p$ to $T_L$ )	6 °C/sec max
Time 25 °C to peak temperature	8 mn max

## 8. Quality & User information

---

### 8.1. Certifications

- ✚ Canada: IC– Certification 11306A-ISP1907
- ✚ CE: CE Certified, Complies with 2014/53/EU, EN300328 V2.2.2 – EC DoC TR211204
- ✚ Japan: TELEC certification 020-210045
- ✚ South Korea: KCC certification R-C-iNs-ISP1907
- ✚ USA : FCC Identifier 2AAQS-ISP1907
- ✚ Bluetooth SIG declaration ID D050647
- ✚ RoHS3 compliant
- ✚ Reach compliant
- ✚ Minerals responsible initiative

### 8.2. USA – User information

This intends to inform how to specify the FCC ID of our module “ISP1907” on the product. Based on the Public Notice from FCC, the host device should have a label which indicates that it contains our module. The label should use wording such as:

“Contains FCC ID: 2AAQS-ISP1907”

Any similar wording that expresses the same meaning may be used.

The label of the host device should also include the below FCC Statement. When it is not possible, this information should be included in the User Manual of the host device:

*“This device complies with part 15 of the FCC rules. Operation is subject to the following two conditions.*

*(1) This device may not cause harmful interference*

*(2) This device must accept any interference received, including interference that may cause undesired operation.*

*Caution: Any Changes or modifications not expressly approved by the party responsible for compliance could void the user’s authority to operate the equipment.”*

### 8.3. Canada – User information

This intends to inform how to specify the IC ID of our module “ISP1907” on the product. According to Canadian standards “RSS-210” and “RSS-Gen”, the host device should have a label which indicates that it contains our module. The label should use wording such as:



“Contains IC: 11306A-ISP1907”

Any similar wording that expresses the same meaning may be used.

The label of the host device should also include the below IC Statement. When it is not possible, this information should be included in the User Manual of the host device:

*“This device complies with Industry Canada licence-exempt RSS standard(s). Operation is subject to the following two conditions: (1) this device may not cause interference, and (2) this device must accept any interference, including interference that may cause undesired operation of the device.*

*Le présent appareil est conforme aux CNR d'Industrie Canada applicables aux appareils radio exempts de licence. L'exploitation est autorisée aux deux conditions suivantes : (1) l'appareil ne doit pas produire de brouillage, et (2) l'utilisateur de l'appareil doit accepter tout brouillage radioélectrique subi, même si le brouillage est susceptible d'en compromettre le fonctionnement.”*

#### **8.4. RF Exposure Information**

This equipment complies with FCC/IC radiation exposure limits set forth for an uncontrolled environment and meets the FCC radio frequency (RF) Exposure Guidelines in Supplement C to OET65 and RSS-102 of the IC radio frequency (RF) Exposure rules. This equipment has very low levels of RF energy that it deemed to comply without maximum permissive exposure evaluation (MPE).

#### **8.5. Informations concernant l'exposition aux fréquences radio (RF)**

La puissance de sortie émise par l'appareil de sans-fil est inférieure à la limite d'exposition aux fréquences radio d'Industry Canada (IC). Ce module a également été évalué et démontré conforme aux limites d'exposition aux RF d'IC dans des conditions d'exposition à des appareils mobiles et/ou portables.

#### **8.6. Discontinuity**

Normally a product will continue to be manufactured as long as all of the following are true:

- The manufacturing method is still available.
- There are no replacement products.
- There is demand for it in the market.

In case of obsolescence, Insight SiP will follow Jedec Standard JSD-48. A Product Discontinuation Notice (PDN) will be sent to all distributors and made available on our website. After this, the procedure goes as follows:

- Last Order Date will be 6 months after the PDN was published.
- Last Shipment Date will be 6 months after Last Order Date, i.e. 12 months after PDN.

## 8.7. Disclaimer

Insight SiP's products are designed and manufactured for general consumer applications, so testing and use of the product shall be conducted at customer's own risk and responsibility. Please conduct validation and verification and sufficient reliability evaluation of the products in actual condition of mounting and operating environment before commercial shipment of the equipment. Please also pay attention (i) to apply soldering method that don't deteriorate reliability, (ii) to minimize any mechanical vibration, shock, exposure to any static electricity, (iii) not to overstress the product during and after the soldering process.

The products are not designed for use in any application which requires especially high reliability where malfunction of these products can reasonably be expected to result in personal injury or damage to the third party's life, body or property, including and not limited to (i) aircraft equipment, (ii) aerospace equipment, (iii) undersea equipment, (iv) power plant control equipment, (v) medical equipment, (vi) transportation equipment, (vii) traffic signal equipment, (viii) disaster prevention / crime prevention equipment.

The only warranty that Insight SiP provides regarding the products is its conformance to specifications provided in datasheets. Insight SiP hereby disclaims all other warranties regarding the products, express or implied, including without limitation any warranty of fitness for a particular purpose, that they are defect-free, or against infringement of intellectual property rights. Insight SiP customers agree to indemnify and defend Insight SiP against all claims, damages, costs and expenses that may be incurred, including without any limitation, attorney fees and costs, due to the use of products.