



SPDT, IP64 Rated Electromechanical Relay
Latching Switch, Terminated, DC to 18 GHz, 90W,
TTL, Indicators, diodes, 12VDC, SMA

Electromechanical Relay Switches Technical Data Sheet

PE71S6528

Features

- SPDT Electromechanical Relay Switch
- /IP64 Level 1 Rated
- DC to 18 GHz Frequency Range
- Latching Actuator
- Internal 50 Ohm Terminations
- TTL Control Logic
- Indicators
- Suppression Diodes
- 2M Lifecycle Rating
- Insertion Loss 0.2 dB typ
- Isolation > 85 dB typ
- VSWR as low as 1.2:1 max
- SMA Female Connectors
- +12 Volt DC Bias
- Solder Terminal Pins for DC Command Control
- -54°C to +85°C Operating Temperature
- Up to 90 Watt Average Power Handling
- 50 Ohm Design
- Hot Switching Capability - Consult Factory
- S-Parameter Data available upon request
- Rugged Design meets Mil-STD-202 Test Conditions

Applications

- Aerospace & Defense
- Test & Measurement
- Microwave Radio Systems
- Military & Commercial Communication Systems
- Research & Development
- SATCOM
- Wireless Communications
- Enterprise
- IoT

Description

The PE71S6528 is a Ruggedized SPDT electromechanical relay switch that operates across a broadband frequency range from DC to 18 GHz and can handle up to 90W of average power in a break before make condition. The 50 Ohm design is IP64 compliant with a Level 1 moisture seal and specially designed to operate reliably in harsh usage environments and conditions, such as over extreme temperatures and wet or dusty environments. Intrusion protection offers full protection against dust and other particulants. Moisture protection enables resistance to splashes in all directions. The switch has a Latching Actuator that magnetically latches in place after the control voltage is removed. For power sensitive applications, this is the best actuator option. The output ports are terminated in 50 ohms when switched in the isolation (off) state. Additional features include TTL logic control, indicators to monitor the switch position, and suppression diodes which limit voltage spikes or reverse current. Impressive typical performance includes 0.2 dB insertion loss and isolation greater than 85 dB. This switch requires +12Vdc bias voltage, operates over a temperature range of -54°C to +85°C, and is rated for 2 million lifecycles. The rugged and compact package assembly supports SMA female connectors and solder terminal pins for DC command control functions. And for highly reliable operation, the model is guaranteed to meet MIL-STD-202 environmental test conditions for shock and random vibration.

Electrical Specifications (TA = 25°C, DC Voltage = 12 Vdc)

Switch Type	SPDT
Actuator Type	Latching
Actuator Options	Indicators, Diodes
TTL Control	on: 2.4 to 5.5 Volts off: 0 to 0.8 Volts

Description	Minimum	Typical	Maximum	Units
Frequency Range	DC		18	GHz
Impedance		50		Ohms

Click the following link (or enter part number in "SEARCH" on website) to obtain additional part information including price, inventory and certifications: [SPDT, IP64 Rated Electromechanical Relay Latching Switch, Terminated, DC to 18 GHz, 90W, TTL, Indicators, diodes, 12VDC, SMA PE71S6528](#)



SPDT, IP64 Rated Electromechanical Relay
Latching Switch, Terminated, DC to 18 GHz, 90W,
TTL, Indicators, diodes, 12VDC, SMA

Electromechanical Relay Switches Technical Data

PE71S6528

Operating Voltage	11	12	13	Volts
Actuating Set Current			420	mA
VSWR		1.15:1	1.4:1	
Insertion Loss		0.2	0.4	dB
Isolation	65	90		dB
Switching Time		<20		ms Typ

Performance by Frequency

Description	F1	F2	F3	F4	F5	Units
Frequency Range	DC to 6	6 to 12	12 to 18			GHz
VSWR, Max	1.2:1	1.3:1	1.4:1			
Insertion Loss, Max	0.15	0.25	0.4			dB
Isolation, Min	85	70	65			dB

Mechanical Specifications

Size

Length	2.05 in [52.07 mm]
Width/Diameter	1.5 in [38.1 mm]
Height	0.52 in [13.21 mm]
Weight	0.072 lbs [32.66 g]

Connectors

RF Connector Type	Terminal Female
Control Connector	Solder Terminals

Environmental Specifications

Temperature

Operating Range	-54 to +85 deg C
Storage Range	-55 to +100 deg C

Ingress Protection (IP) Rating
Shock

IP64
MIL-STD-202 Method 213, Condition D, 500 G (non oper)

Vibration

MIL-STD-202 Method 204, Condition D, 10G RMS (non oper)

Click the following link (or enter part number in "SEARCH" on website) to obtain additional part information including price, inventory and certifications: [SPDT, IP64 Rated Electromechanical Relay Latching Switch, Terminated, DC to 18 GHz, 90W, TTL, Indicators, diodes, 12VDC, SMA PE71S6528](#)



SPDT, IP64 Rated Electromechanical Relay
Latching Switch, Terminated, DC to 18 GHz, 90W,
TTL, Indicators, diodes, 12VDC, SMA

Electromechanical Relay Switches Technical Data

PE71S6528

Compliance Certifications (see [product page](#) for current document)

Plotted and Other Data

Notes:

Typical Performance Data

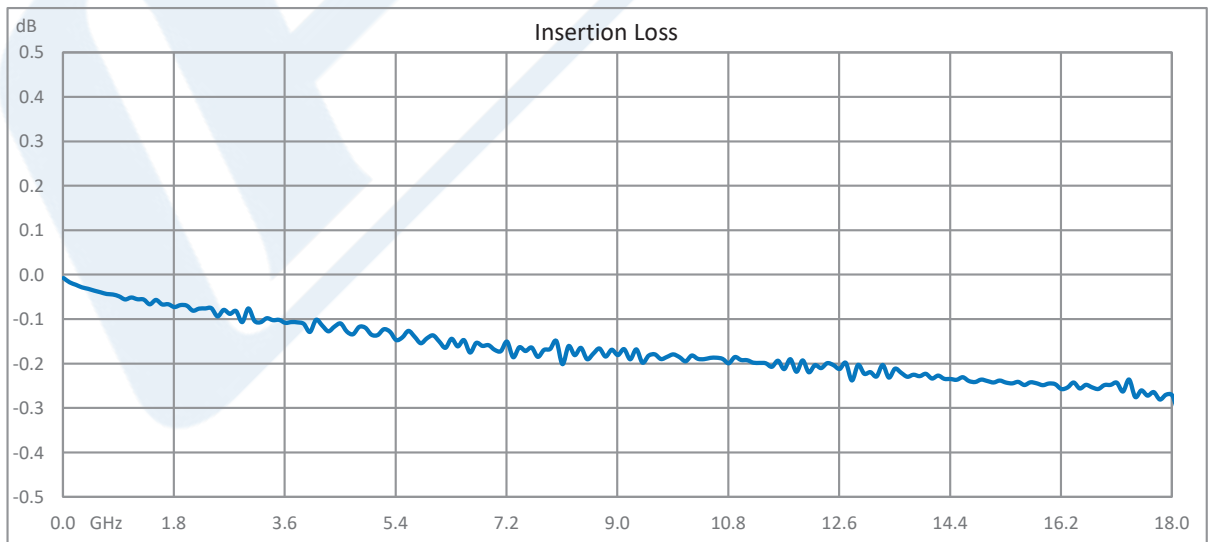
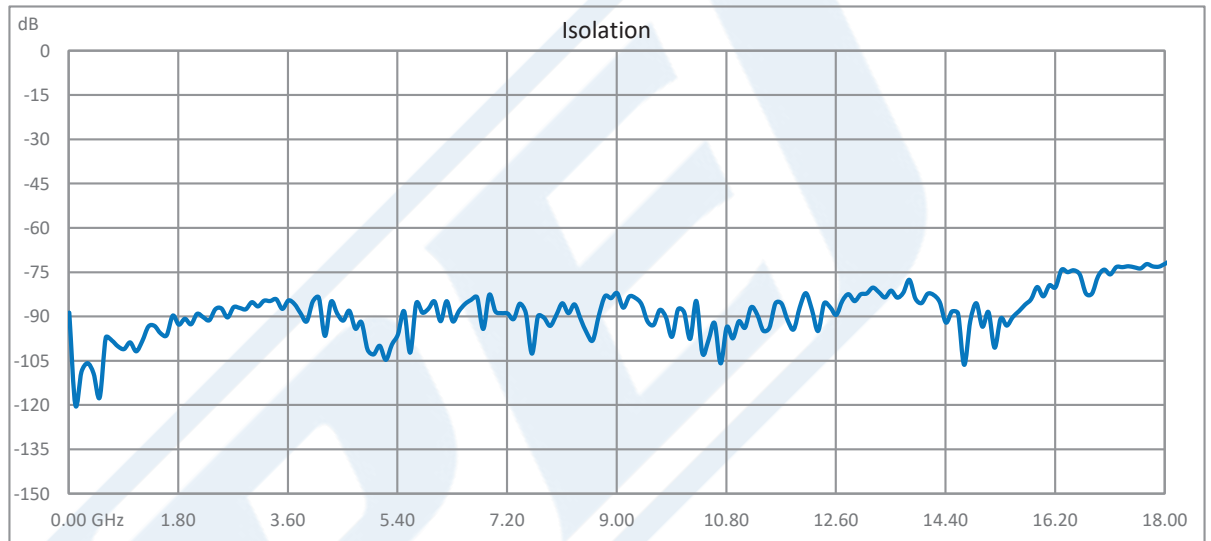

Click the following link (or enter part number in "SEARCH" on website) to obtain additional part information including price, inventory and certifications: [SPDT, IP64 Rated Electromechanical Relay Latching Switch, Terminated, DC to 18 GHz, 90W, TTL, Indicators, diodes, 12VDC, SMA PE71S6528](#)



SPDT, IP64 Rated Electromechanical Relay
Latching Switch, Terminated, DC to 18 GHz, 90W,
TTL, Indicators, diodes, 12VDC, SMA

Electromechanical Relay Switches Technical Data

PE71S6528

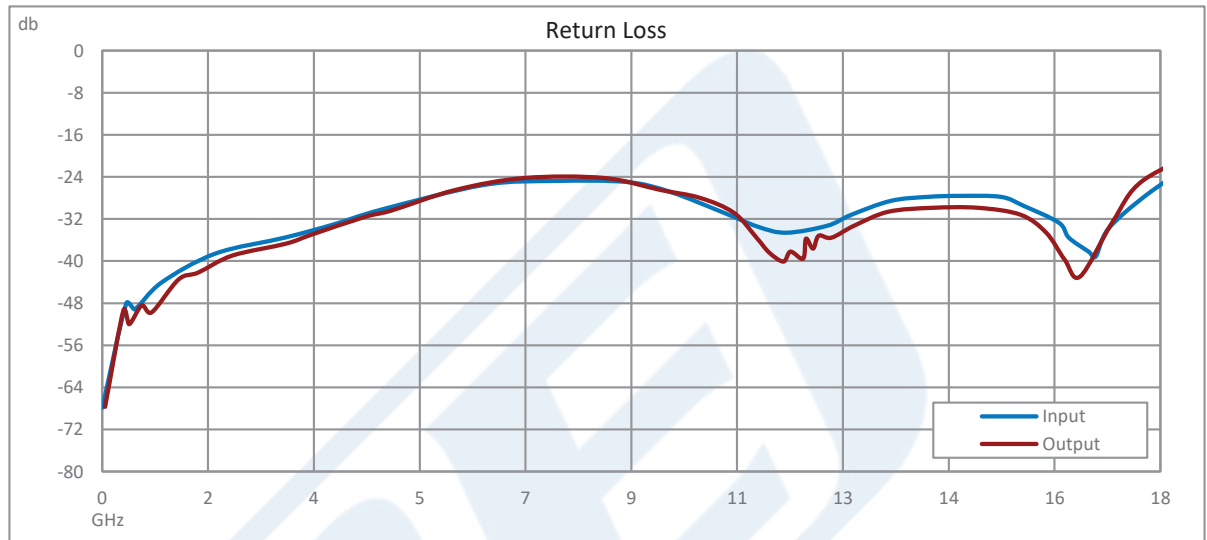

Click the following link (or enter part number in "SEARCH" on website) to obtain additional part information including price, inventory and certifications: [SPDT, IP64 Rated Electromechanical Relay Latching Switch, Terminated, DC to 18 GHz, 90W, TTL, Indicators, diodes, 12VDC, SMA PE71S6528](#)



SPDT, IP64 Rated Electromechanical Relay
Latching Switch, Terminated, DC to 18 GHz, 90W,
TTL, Indicators, diodes, 12VDC, SMA

Electromechanical Relay Switches Technical Data

PE71S6528

Power Handling vs. Frequency

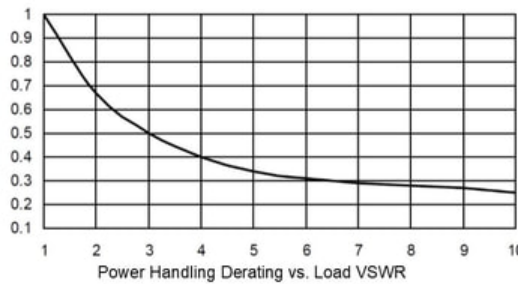
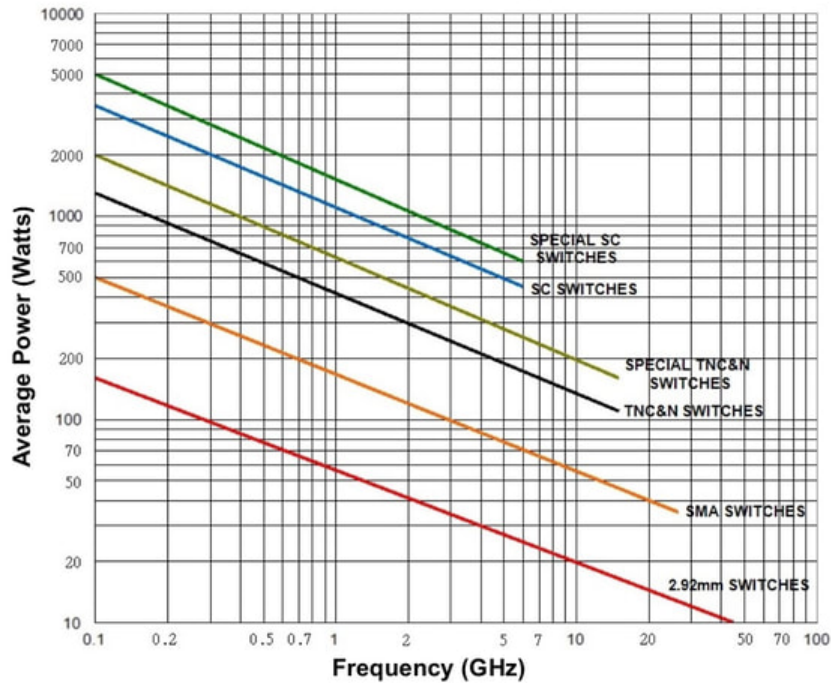

Power handling chart and derating curves based on the following conditions:

- Ambient temperature: 40°C or less
- Altitude: Sea level
- Load VSWR: 1.20:1 Maximum
- Relative Humidity: 40-50%
- Cold switching: RF signal off

Note: specifications subject to change without notice

Click the following link (or enter part number in "SEARCH" on website) to obtain additional part information including price, inventory and certifications: [SPDT, IP64 Rated Electromechanical Relay Latching Switch, Terminated, DC to 18 GHz, 90W, TTL, Indicators, diodes, 12VDC, SMA PE71S6528](#)



SPDT, IP64 Rated Electromechanical Relay
Latching Switch, Terminated, DC to 18 GHz, 90W,
TTL, Indicators, diodes, 12VDC, SMA

Electromechanical Relay Switches Technical Data

PE71S6528

SPDT, IP64 Rated Electromechanical Relay Latching Switch, Terminated, DC to 18 GHz, 90W, TTL, Indicators, diodes, 12VDC, SMA from Pasternack Enterprises has same day shipment for domestic and International orders. Our RF, microwave and millimeter wave products maintain a 99.4% availability and are part of the broadest selection in the industry.

Click the following link (or enter part number in "SEARCH" on website) to obtain additional part information including price, inventory and certifications: [SPDT, IP64 Rated Electromechanical Relay Latching Switch, Terminated, DC to 18 GHz, 90W, TTL, Indicators, diodes, 12VDC, SMA PE71S6528](https://www.pasternack.com/spdt-electromechanical-relay-latching-switch-18-ghz-indicators-diodes-pe71s6528-p.aspx)

URL: <https://www.pasternack.com/spdt-electromechanical-relay-latching-switch-18-ghz-indicators-diodes-pe71s6528-p.aspx>

The information contained in this document is accurate to the best of our knowledge and representative of the part described herein. It may be necessary to make modifications to the part and/or the documentation of the part, in order to implement improvements. Pasternack reserves the right to make such changes as required. Unless otherwise stated, all specifications are nominal. Pasternack does not make any representation or warranty regarding the suitability of the part described herein for any particular purpose, and Pasternack does not assume any liability arising out of the use of any part or documentation.

PE71S6528 CAD Drawing

SPDT, IP64 Rated Electromechanical Relay Latching Switch, Terminated, DC to 18 GHz, 90W, TTL, Indicators, diodes, 12VDC, SMA

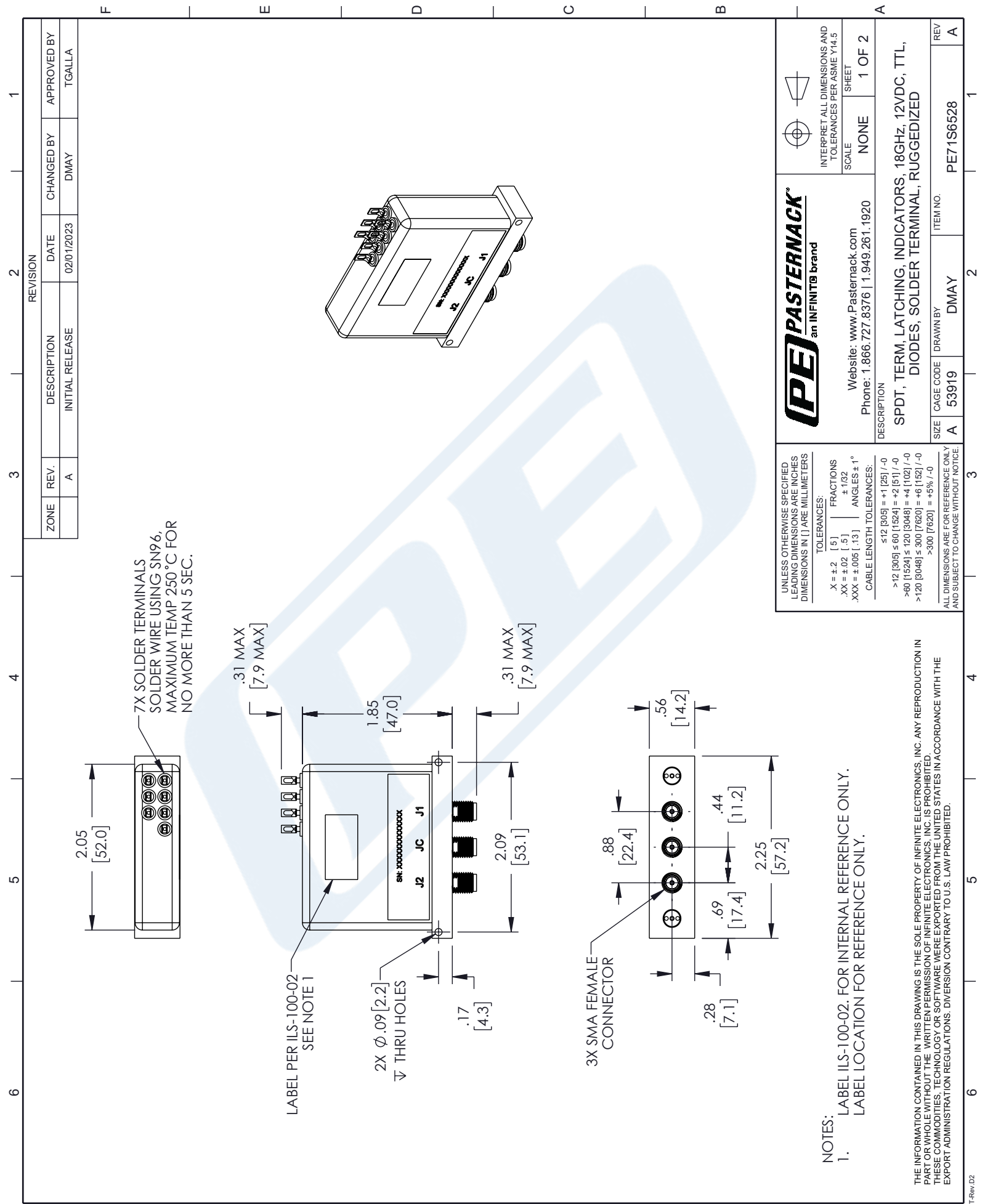

7X SOLDER TERMINALS
SOLDER WIRE USING SN96,
MAXIMUM TEMP 250 °C FOR
NO MORE THAN 5 SEC.

.31 MAX
[7.9 MAX]

.31 MAX
[7.9 MAX]

2.05
[52.0]

LABEL PER ILS-100-02
SEE NOTE 1

2X Ø .09 [2.2]
THRU HOLES

.17
[4.3]

3X SMA FEMALE
CONNECTOR

.88
[22.4]

.56
[14.2]

.28
[7.1]

.69
[17.4]

.44
[11.2]

2.25
[57.2]

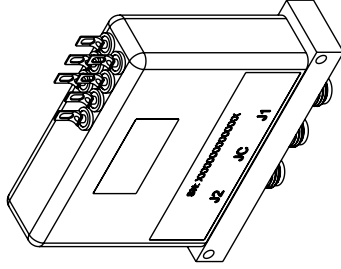

REVISION		DATE	CHANGED BY	APPROVED BY
ZONE	REV.	DESCRIPTION	INITIAL RELEASE	
	A		DMAY	TGALLA

UNLESS OTHERWISE SPECIFIED
LEADING DIMENSIONS ARE INCHES
DIMENSIONS IN [] ARE MILLIMETERS

TOLERANCES:
 X = ±.2 [5] FRACTIONS
 .XX = ±.02 [.5] ± 1/32
 .XXX = ±.005 [.13] ANGLES ± 1°

CABLE LENGTH TOLERANCES:
 ≤ 12 [305] = +1 [25] / -0
 > 12 [305] ≤ 60 [1524] = +2 [51] / -0
 > 60 [1524] ≤ 120 [3048] = +4 [102] / -0
 > 120 [3048] ≤ 300 [7620] = +6 [152] / -0
 > 300 [7620] = +5% / -0

ALL DIMENSIONS ARE FOR REFERENCE ONLY
AND SUBJECT TO CHANGE WITHOUT NOTICE

PE PASTERNAK
an INFINITI® brand

Website: www.Pasternack.com
Phone: 1.866.727.8376 | 1.949.261.1920

DESCRIPTION
 SPDT, TERM, LATCHING, INDICATORS, 18GHZ, 12VDC, TTL,
 DIODES, SOLDER TERMINAL, RUGGEDIZED

SCALE NONE SHEET 1 OF 2

INTERPRET ALL DIMENSIONS AND TOLERANCES PER ASME Y14.5

NOTES:
 1. LABEL ILS-100-02, FOR INTERNAL REFERENCE ONLY.
 LABEL LOCATION FOR REFERENCE ONLY.

THE INFORMATION CONTAINED IN THIS DRAWING IS THE SOLE PROPERTY OF INFINITE ELECTRONICS, INC. ANY REPRODUCTION IN PART OR WHOLE WITHOUT THE WRITTEN PERMISSION OF INFINITE ELECTRONICS, INC. IS PROHIBITED. THESE COMMODITIES, TECHNOLOGY OR SOFTWARE WERE EXPORTED FROM THE UNITED STATES IN ACCORDANCE WITH THE EXPORT ADMINISTRATION REGULATIONS. DIVERSION CONTRARY TO U.S. LAW PROHIBITED.

PE71S6528 CAD Drawing

SPDT, IP64 Rated Electromechanical Relay Latching Switch, Terminated,
DC to 18 GHz, 90W, TTL, Indicators, diodes, 12VDC, SMA

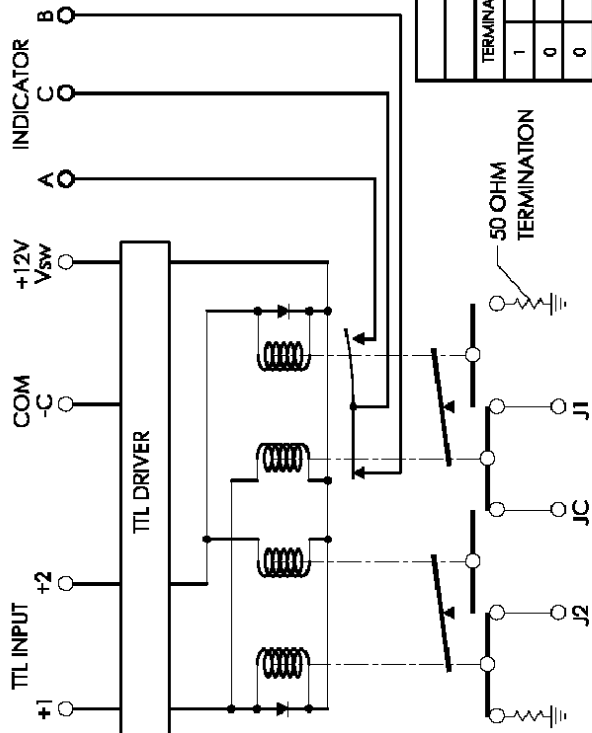

SCHEMATIC

OPERATIONAL LOGIC TABLE					
TERMINALS	RF PORTS	INDICATOR	TERMINATION		
1	J1-JC	B-C	A-C	J2 TERMINATED	J1 TERMINATED
0	NO CHANGE	NO CHANGE	NO CHANGE	NO CHANGE	
0	ON	OFF	ON	OFF	ON
1	ON	ON	OFF	ON	OFF
1	FORBIDDEN	FORBIDDEN	FORBIDDEN	FORBIDDEN	

UNLESS OTHERWISE SPECIFIED LEADING DIMENSIONS ARE INCHES DIMENSIONS IN [] ARE MILLIMETERS

TOLERANCES:
 .X = ±.2 [.5] FRACTIONS
 .XX = ±.02 [.5] ± 1/32
 .XXX = ±.005 [.13] ANGLES ± 1°

CABLE LENGTH TOLERANCES:
 ≤12 [305] = +1 [25] / -0
 >12 [305] ≤60 [1524] = +2 [51] / -0
 >60 [1524] ≤120 [3048] = +4 [102] / -0
 >120 [3048] ≤300 [7620] = +6 [152] / -0
 >300 [7620] = +5% / -0

ALL DIMENSIONS ARE FOR REFERENCE ONLY AND SUBJECT TO CHANGE WITHOUT NOTICE



Website: www.Pasternack.com
 Phone: 1.866.727.8376 | 1.949.261.1920

DESCRIPTION
 SPDT, TERM, LATCHING, INDICATORS, 18GHZ, 12VDC, TTL,
 DIODES, SOLDER TERMINAL, RUGGEDIZED

SIZE A CAGE CODE A 53919 DRAWN BY DMAY ITEM NO. PE71S6528 REV A



INTERPRET ALL DIMENSIONS AND TOLERANCES PER ASME Y14.5
 SCALE NONE SHEET 2 OF 2

THE INFORMATION CONTAINED IN THIS DRAWING IS THE SOLE PROPERTY OF INFINITE ELECTRONICS, INC. ANY REPRODUCTION IN PART OR WHOLE WITHOUT THE WRITTEN PERMISSION OF INFINITE ELECTRONICS, INC. IS PROHIBITED.
 THESE COMMODITIES, TECHNOLOGY OR SOFTWARE WERE EXPORTED FROM THE UNITED STATES IN ACCORDANCE WITH THE EXPORT ADMINISTRATION REGULATIONS. DIVERSION CONTRARY TO U.S. LAW PROHIBITED.