



Datasheet

Monsoon 3-in-1

Part No:
MA172.A.LBC.001

Description:

Monsoon 3-in-1 GNSS, Dual-Band Wi-Fi & LTE
Low Profile Permanent Mount Antenna

Features:

- 1*LTE Antenna
- 1*Dual-Band Wi-Fi Antenna (2.4/5.8 GHz)
- 1*Active GNSS Antenna - GPS L1 and GLONASS L1
- Permanent (Screw) Mount
- IP67 Rated, Robust PC/ABS Enclosure
- LTE: 3M CFD200 Cable and SMA(M)ST Connector
- Wi-Fi: 3M CFD200 Cable and RP-SMA(M)ST Connector
- GNSS: 3M RG-174 Cable and SMA(M)ST Connector
- Dimensions: 204 * 69 * 31 mm
- Cables & Connectors Customizable
- REACH & RoHS Compliant

1. Introduction	3
2. Specifications	4
3. Antenna Characteristics	9
4. Radiation Patterns	18
5. Mechanical Drawing	29
6. Packaging	30
<hr/>	
Changelog	31

Taoglas makes no warranties based on the accuracy or completeness of the contents of this document and reserves the right to make changes to specifications and product descriptions at any time without notice. Taoglas reserves all rights to this document and the information contained herein. Reproduction, use or disclosure to third parties without express permission is strictly prohibited. Copyright © Taoglas Ltd.



1. Introduction



The Monsoon MA172 is a low profile 3-in-1 combination antenna. It integrates high-performing LTE and Wi-Fi antennas with an active GNSS antenna that supports both the GPS L1 and GLONASS L1 bands. All antennas are enclosed in an IP67 rated waterproof housing, designed for use in the most rugged of environments.

Typical applications include:

- HD Video over LTE -First Responder and Emergency Services
- Intelligent Transport Systems
- Internet of Things (IoT market)
- High Definition Video Broadcast Systems
- Wireless LTE M2M Devices
- Digital Signage

Both the LTE antenna and the Wi-Fi antenna are designed for high efficiency, even without a ground plane. 4G LTE applications demand high speed data uplink and downlink and the high efficiency and gain characteristics exhibited by this antenna help to achieve the required signal to noise ratio and throughput to solve these challenges. Low loss cables are used to keep efficiency high over long cable lengths.

The GNSS antenna has been optimized to work on both GPS and GLONASS bands. Dual GPS/GLONASS systems can accelerate time to first fix, especially in challenging environments such as urban canyons or any environment where a large portion of the sky is blocked. A front-end SAW filter protects the GNSS antenna's LNA from potentially damaging out-of-band wireless transmissions, ensuring that it can be used in environments where these signals might be encountered.

Cable and connectors are customizable, contact your regional Taoglas sales office for customization and additional support.

2. Specifications

GNSS Electrical			
Frequency	GPS L1: 1575.42 MHz \pm 1.023 MHz GLONASS L1: 1602 MHz \pm 1.023 MHz		
Bandwidth - Return Loss <-10 dB	6 MHz min		
Return loss (GPS L1 GLONASS L1)	< -10 dB		
Passive Gain at Zenith (GPS L1 and GLONASS L1)	+1.0 dBic typ.		
Polarization	RHCP		
Impedance	50 Ω		
LNA Out-band Attenuation	fo = 1575.42MHz fo \pm 30 MHz 5dB Min. fo \pm 50 MHz 20dB Min. fo \pm 100 MHz 25dB Min.		
Input Voltage	Min:1.8V	Typ. 3.0V	Max: 5.5V
Total Gain @ Zenith	25dBic	30dBic	32dBic
Current Consumption	6mA	12mA	30mA
Noise Figure	2.7dB	3.0dB	3.7dB

5G/4G Antenna

Band	Frequency (MHz)		Efficiency (%)	Average Gain (dB)	Peak Gain (dBi)	Impedance	Max Input Power	Polarization	Radiation Pattern
4G/3G Band 12,13,14,17,28,29	698~824	Free space	34	-4.64	0.79	50 Ω	10W	Vertical	Omni-Directional
		On 30x30cm Ground Plane	42	-3.91	1.05				
4G/3G/NB-IoT/Cat M Band 5,8,18,19,20,26,27	824~960	Free space	48	-3.26	2.74				
		On 30x30cm Ground Plane	43	-3.74	2.21				
5GNR/4G Band 21,32,74,75,76	1427~1518	Free space	53	-2.74	2.66				
		On 30x30cm Ground Plane	48	-3.18	4.49				
4G/3G Band 1,2,3,4,9,23,25,35,39,66	1710~2200	Free space	60	-2.20	3.83				
		On 30x30cm Ground Plane	58	-2.40	5.25				
4G/3G Band 7,30,38,40,41	2300~2690	Free space	52	-2.86	4.04				
		On 30x30cm Ground Plane	49	-3.14	5.86				
5GNR/4G Band 22,42,48,77,78,79	3300~5000	Free space	46	-3.53	4.12				
		On 30x30cm Ground Plane	42	-4.09	6.39				
LTE5200/ Wi-Fi 5800	5150~5925	Free space	13	-8.97	-0.01				
		On 30x30cm Ground Plane	9	-10.72	0.65				

Wi-Fi Antenna (2.4GHz/5.8GHz)								
Frequency (MHz)			Efficiency (%)	Average Gain (dB)	Peak Gain (dBi)	Impedance	Return Loss	Radiation Pattern
2400~2500	Free space	30cm	65.35	-1.85	-0.99	50 Ω	< -6 dB	Vertical
		1M	59.60	-2.25	-1.39			
		2M	51.91	-2.85	-1.99			
		3M	45.21	-3.45	-2.59			
	On 30x30cm Ground Plane	30cm	64.51	-1.90	-2.59			
		1M	58.84	-2.30	-1.15			
		2M	51.25	-2.90	-1.55			
		3M	44.64	-3.50	-2.15			
4900~5850	Free Space	30cm	49.83	-3.03	-1.95			
		1M	42.96	-3.67	-2.55			
		2M	34.82	-4.58	-3.45			
		3M	28.22	-5.49	-4.35			
	On 30x30cm Ground Plane	30cm	51.58	-2.88	-1.81			
		1M	44.46	-3.52	-2.41			
		2M	36.05	-4.43	-3.31			
		3M	29.21	-5.34	-4.21			

Mechanical	
Dimensions	203.95 x 68.96 x 30.95 mm
Cable	LTE: 3000mm CFD200 Wi-Fi: 3000mm CFD200 GNSS: 3000mm RG174
Connector	LTE: SMA(M) Wi-Fi: RP-SMA(M) GNSS: SMA(M)
Casing	PC+ABS
Adhesive	3M 9448HK + CR4305
Sealant	Rubber Stopper
Weight	550 g
Environmental	
Protection	IP67
Corrosion	5% NaCl for 96hrs - Nickel plated steel base and thread
Temperature Range	-40°C to +85°C
Thermal Shock	100 cycles -40°C to +85°C
Humidity	Non-condensing 65°C 95% RH
Shock (Drop Test)	1m drop on concrete 6 axes
Recommended Mounting Torque	24.5N·m
Maximum Mounting Torque	29.5N·m

5G/4G Bands			
Band Number	5GNR / FR1 / LTE / LTE-Advanced / WCDMA / HSPA / HSPA+ / TD-SCDMA		
	Uplink	Downlink	Covered
1	UL: 1920 to 1980	DL: 2110 to 2170	✓
2	UL: 1850 to 1910	DL: 1930 to 1990	✓
3	UL: 1710 to 1785	DL: 1805 to 1880	✓
4	UL: 1710 to 1755	DL: 2110 to 2155	✓
5	UL: 824 to 849	DL: 869 to 894	✓
7	UL: 2500 to 2570	DL: 2620 to 2690	✓
8	UL: 880 to 915	DL: 925 to 960	✓
9	UL: 1749.9 to 1784.9	DL: 1844.9 to 1879.9	✓
11	UL: 1427.9 to 1447.9	DL: 1475.9 to 1495.9	✓
12	UL: 699 to 716	DL: 729 to 746	✓
13	UL: 777 to 787	DL: 746 to 756	✓
14	UL: 788 to 798	DL: 758 to 768	✓
17	UL: 704 to 716	DL: 734 to 746	✓
18	UL: 815 to 830	DL: 860 to 875	✓
19	UL: 830 to 845	DL: 875 to 890	✓
20	UL: 832 to 862	DL: 791 to 821	✓
21	UL: 1447.9 to 1462.9	DL: 1495.9 to 1510.9	✓
22	UL: 3410 to 3490	DL: 3510 to 3590	✓
23	UL: 2000 to 2020	DL: 2180 to 2200	✓
24	UL: 1625.5 to 1660.5	DL: 1525 to 1559	✓
25	UL: 1850 to 1915	DL: 1930 to 1995	✓
26	UL: 814 to 849	DL: 859 to 894	✓
27	UL: 807 to 824	DL: 852 to 869	✓
28	UL: 703 to 748	DL: 758 to 803	✓
29	UL: -	DL: 717 to 728	✓
30	UL: 2305 to 2315	DL: 2350 to 2360	✓
31	UL: 452.5 to 457.5	DL: 462.5 to 467.5	✗
32	UL: -	DL: 1452 - 1496	✓
35		1850 to 1910	✓
38		2570 to 2620	✓
39		1880 to 1920	✓
40		2300 to 2400	✓
41		2496 to 2690	✓
42		3400 to 3600	✓
43		3600 to 3800	✓
48		3550 to 3700	✓
66	UL: 1710-1780	DL: 2110-2200	✓
71		617 to 698	✓
74/75/76		1427 to 1518	✓
78		3300 to 3800	✓
79		4400 to 5000	✓
85	698-716	728-746	✓

3. Antenna Characteristics

3.1 Return Loss – LTE (Free space)

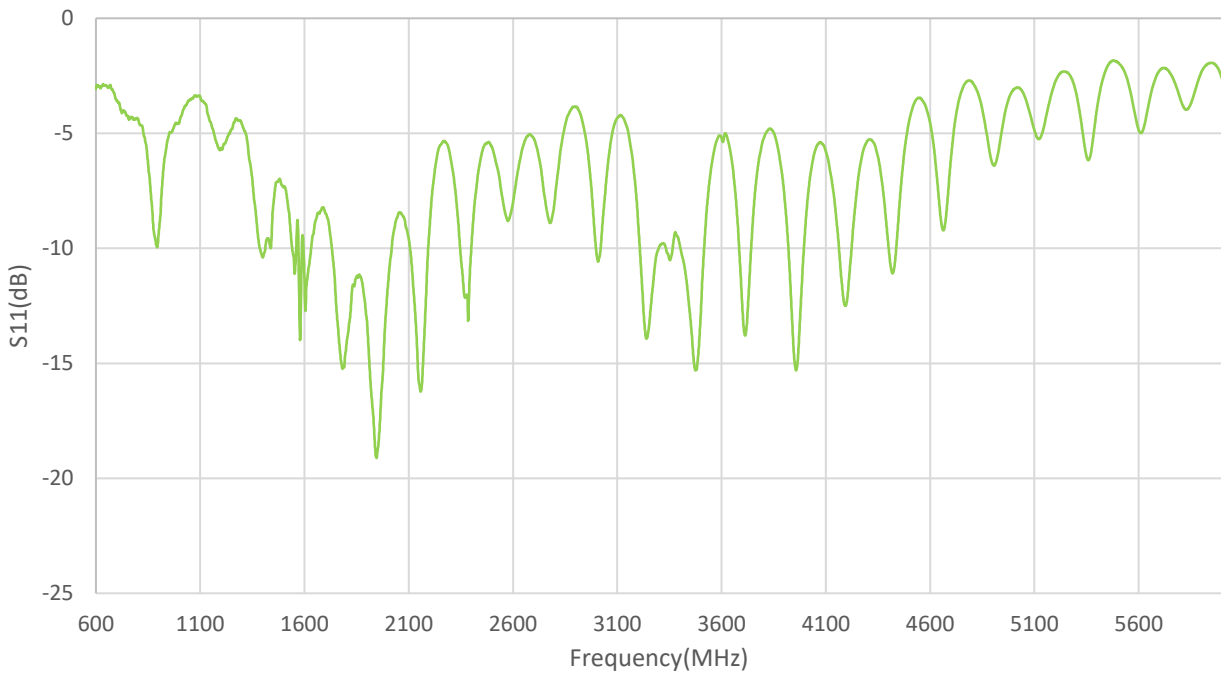

3.2 Return Loss – LTE (30cmx30cm Ground Plane)

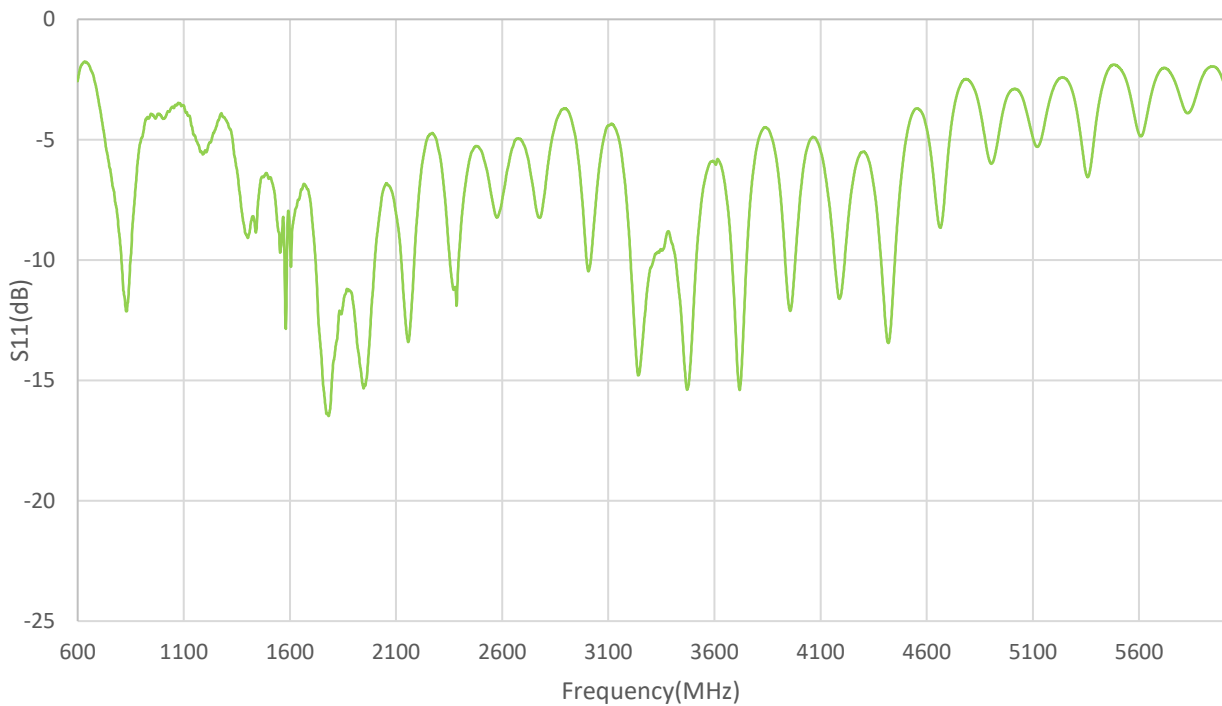

3.3 Efficiency – 5G/4G (Free space)

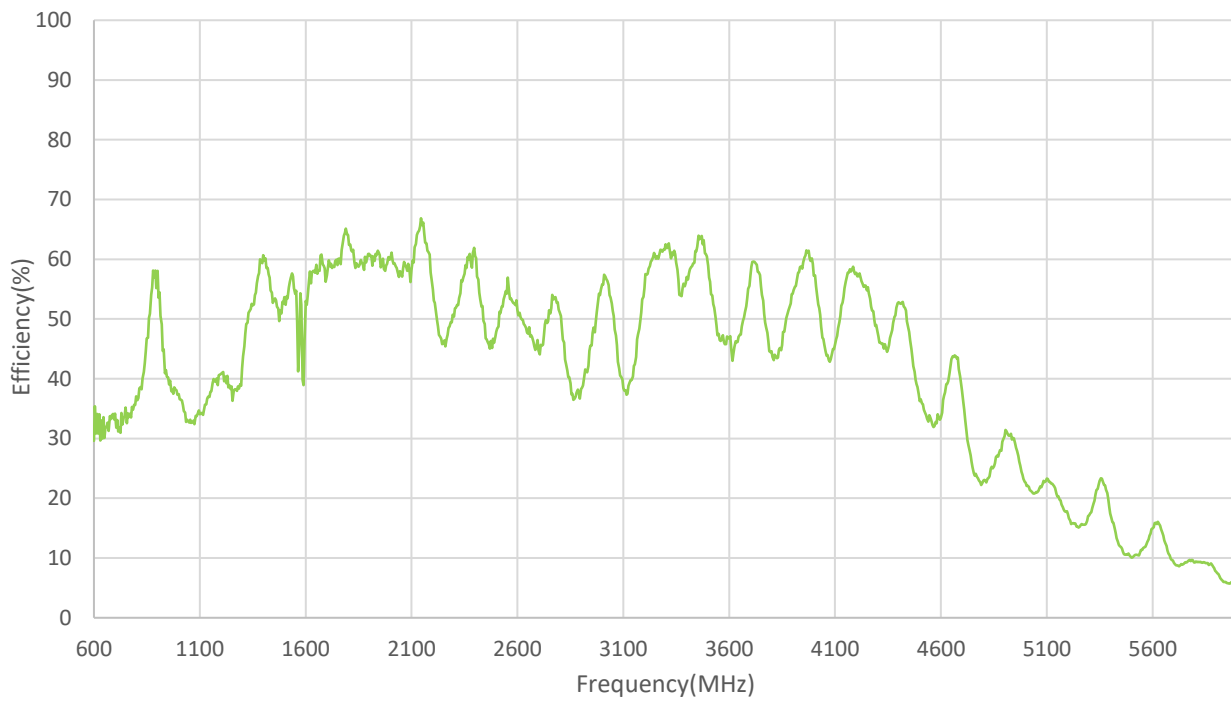

3.4 Efficiency – 5G/4G (30cmx30cm Ground Plane)

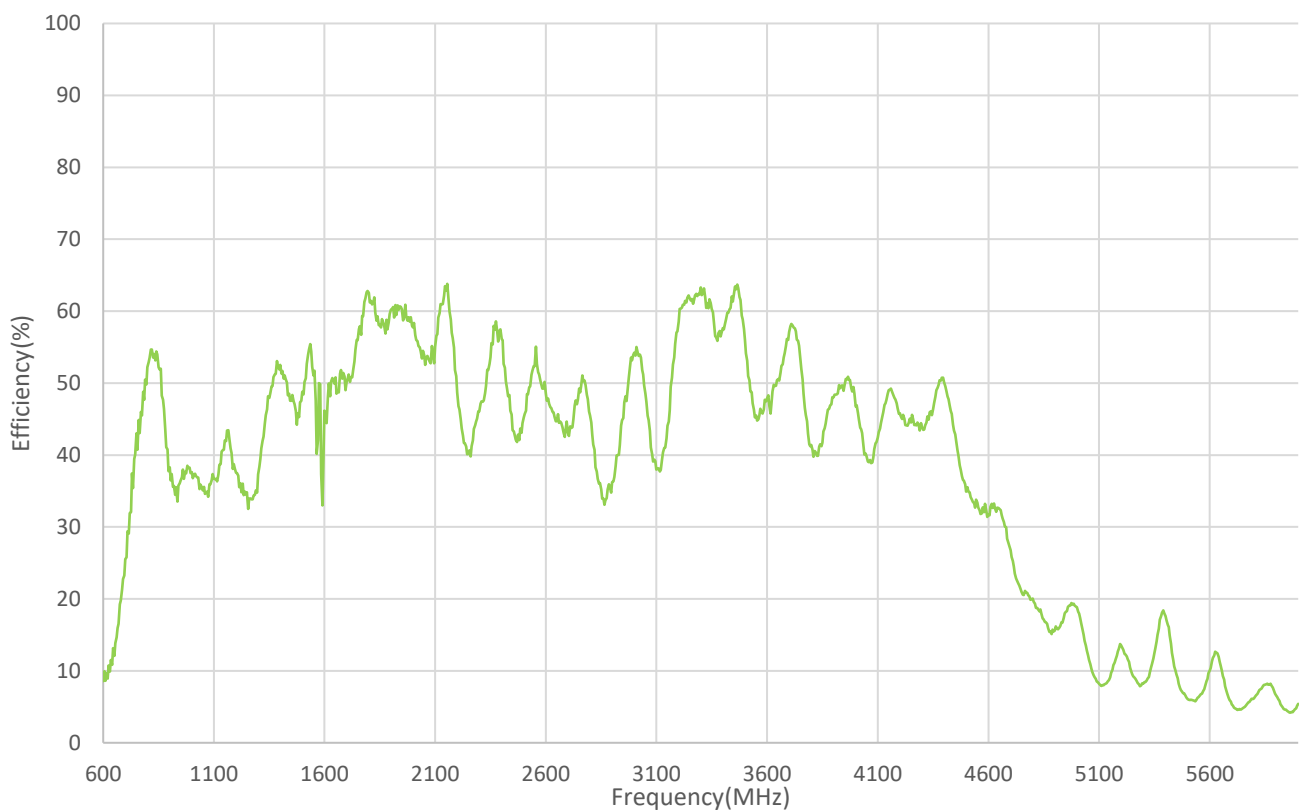

3.5 Average Gain – 5G/4G (Free space)

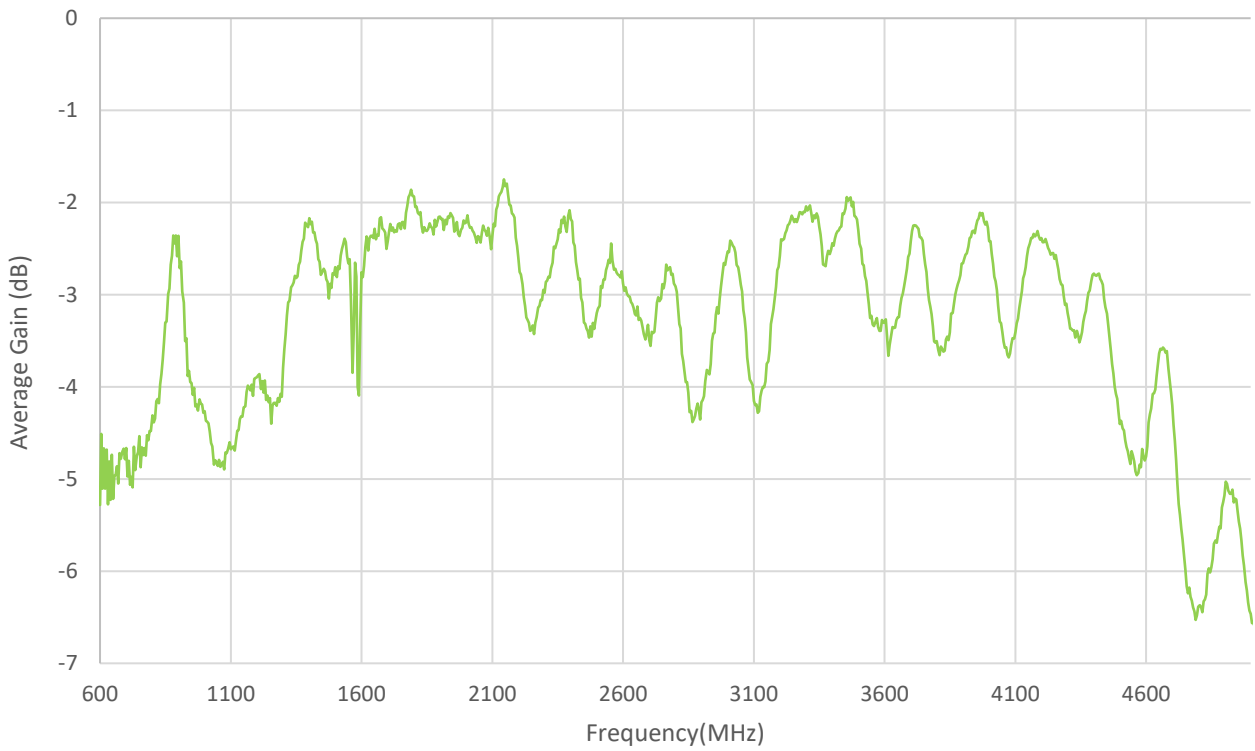

3.6 Average Gain – 5G/4G (30cmx30cm Ground Plane)

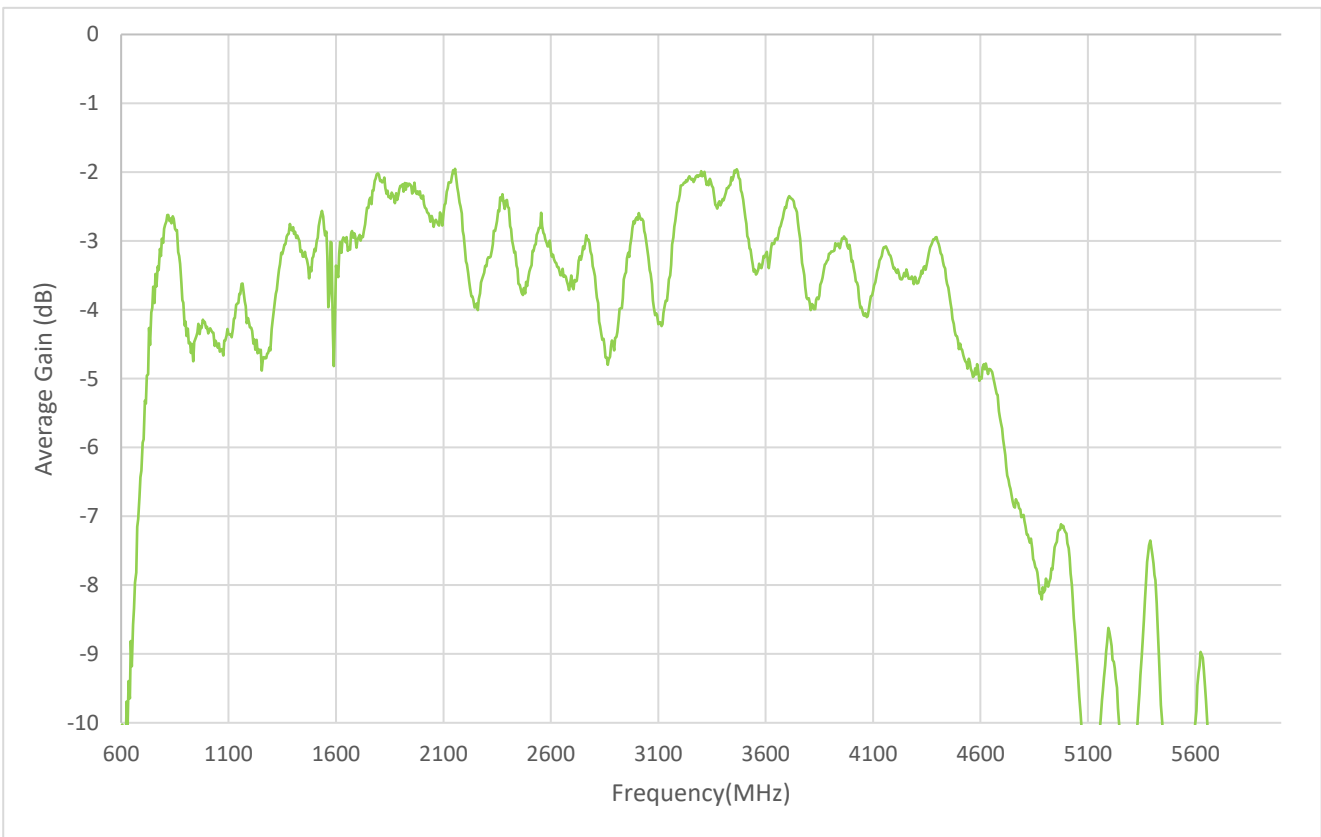

3.7 Peak Gain – 5G/4G (Free space)

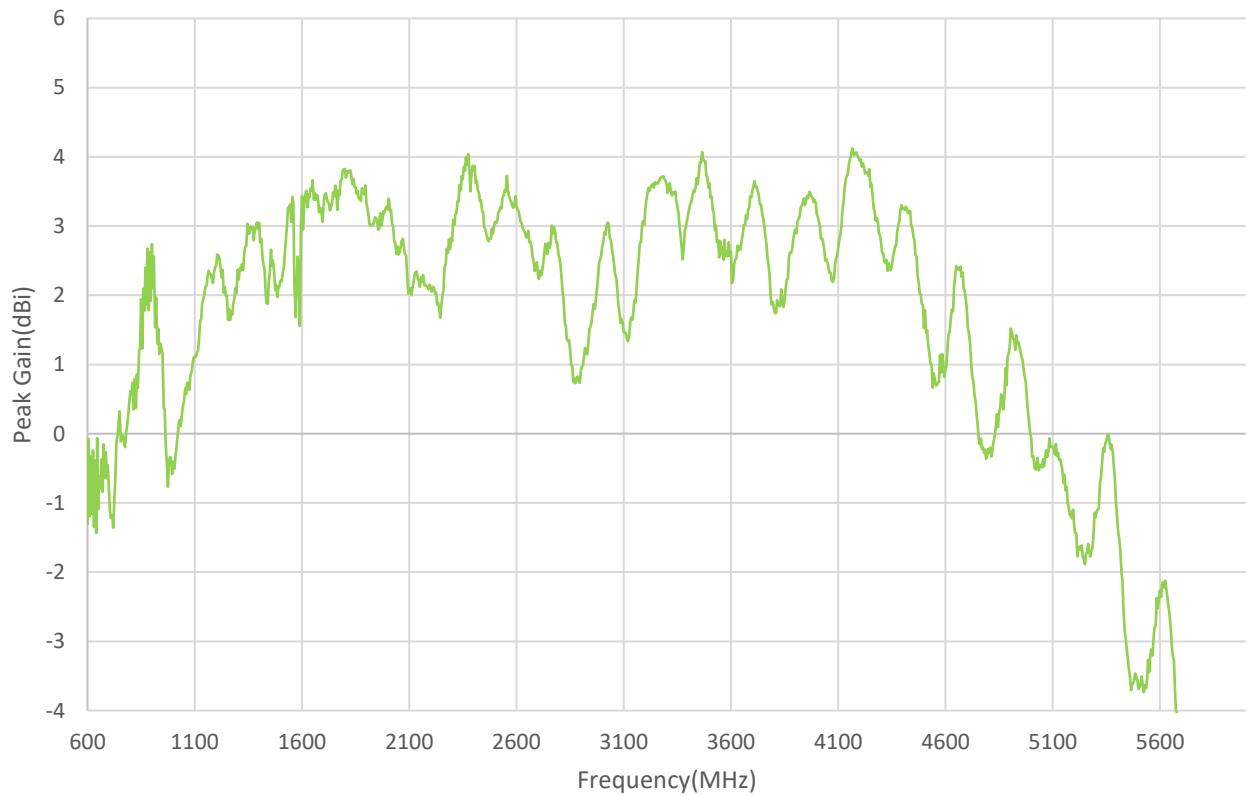

3.8 Peak Gain – 5G/4G (30cmx30cm Ground Plane)

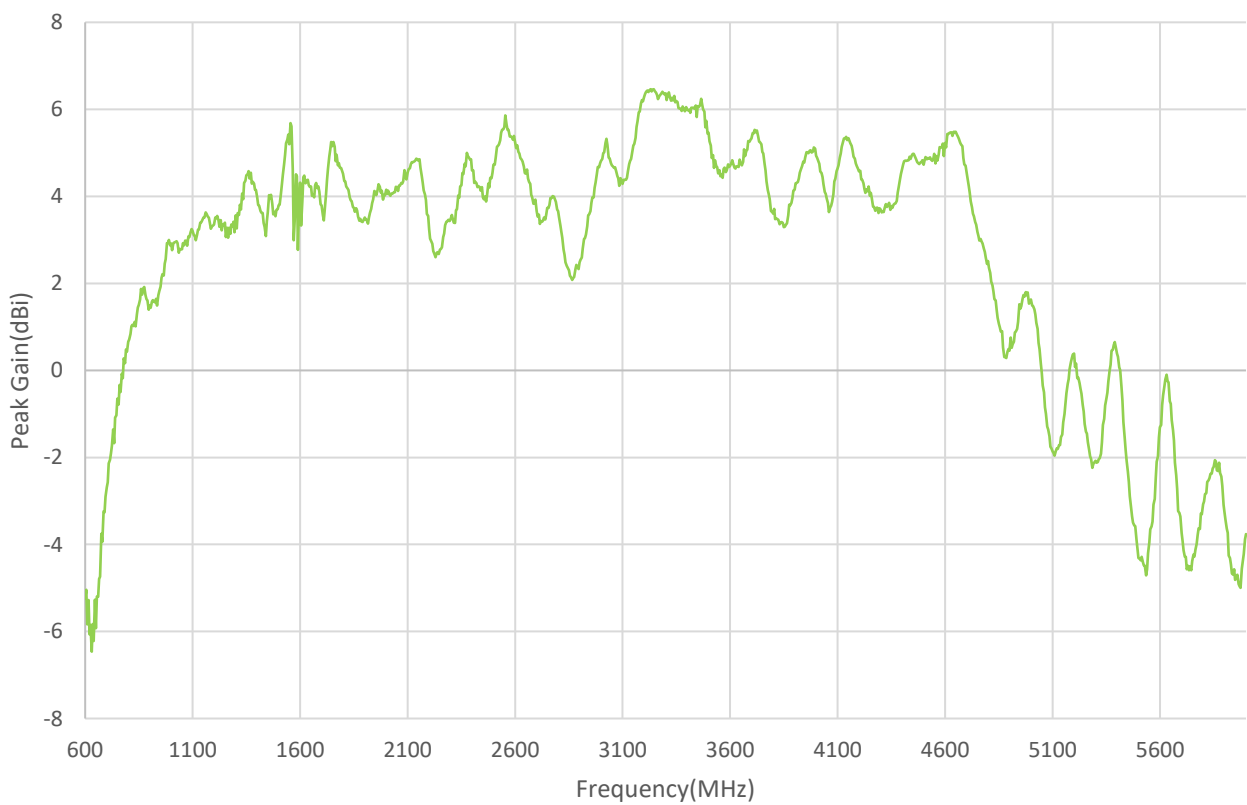

3.9 GNSS Antenna – Block Diagram (Active Antenna)

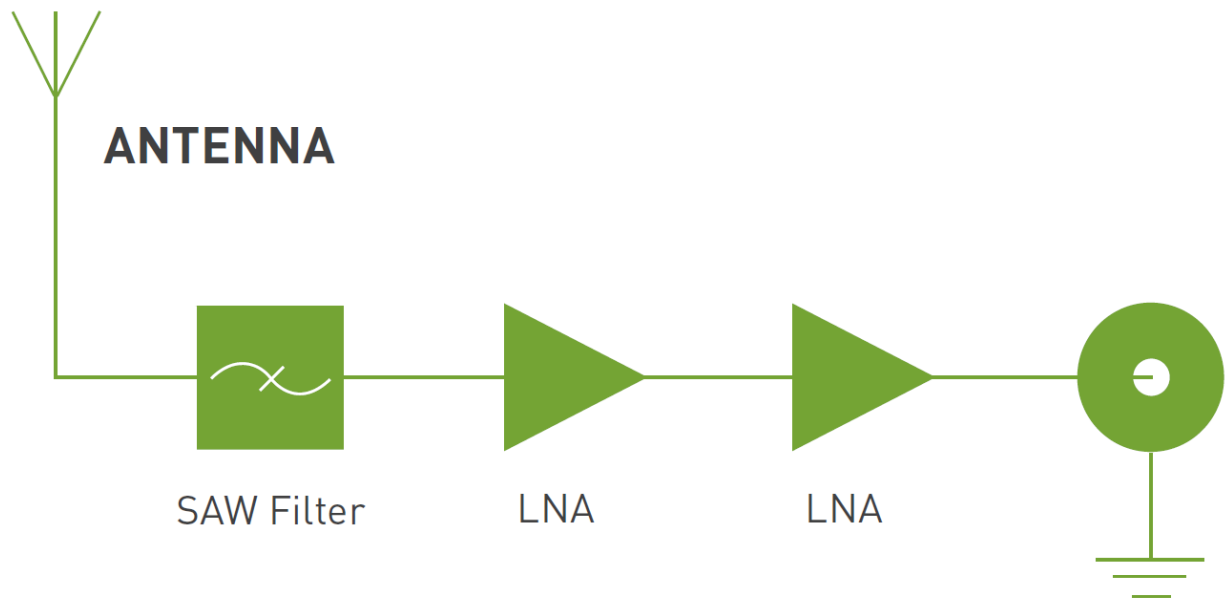

3.10 GNSS Antenna – Return Loss

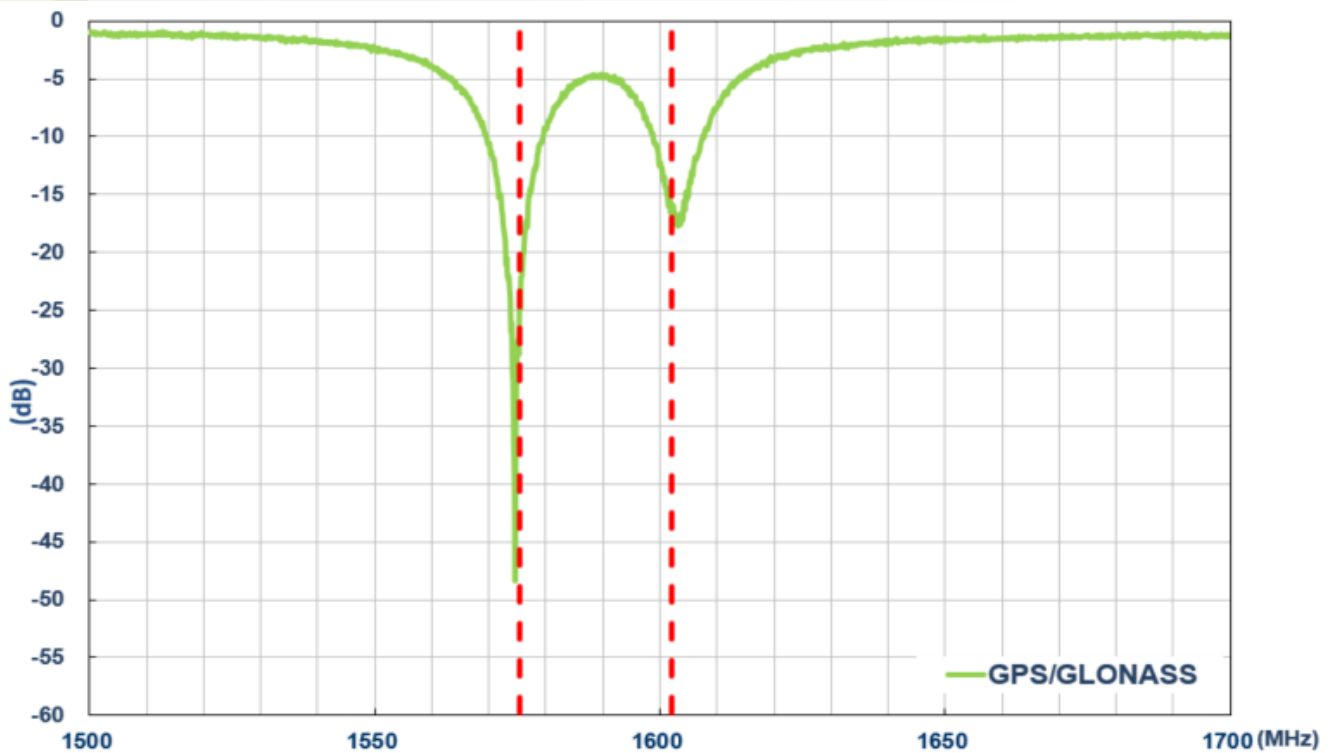

3.11 GNSS Antenna – Efficiency (Passive Measurement)

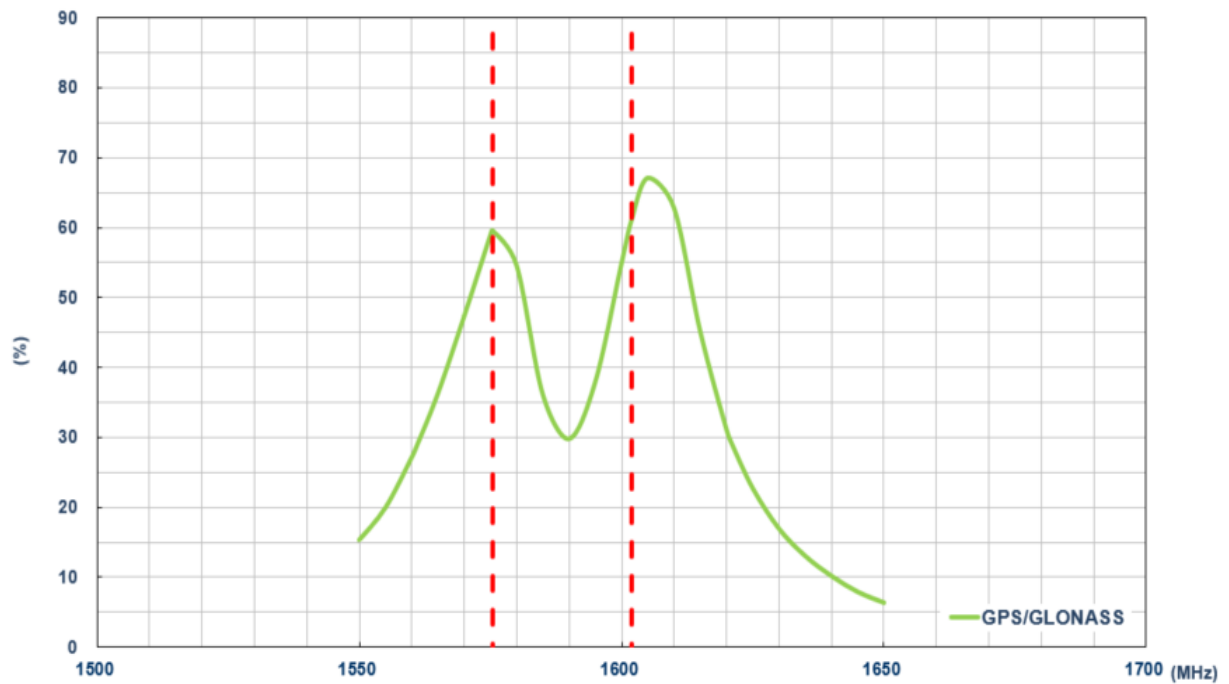

3.12 GNSS Antenna – Average Gain (Passive Measurement)

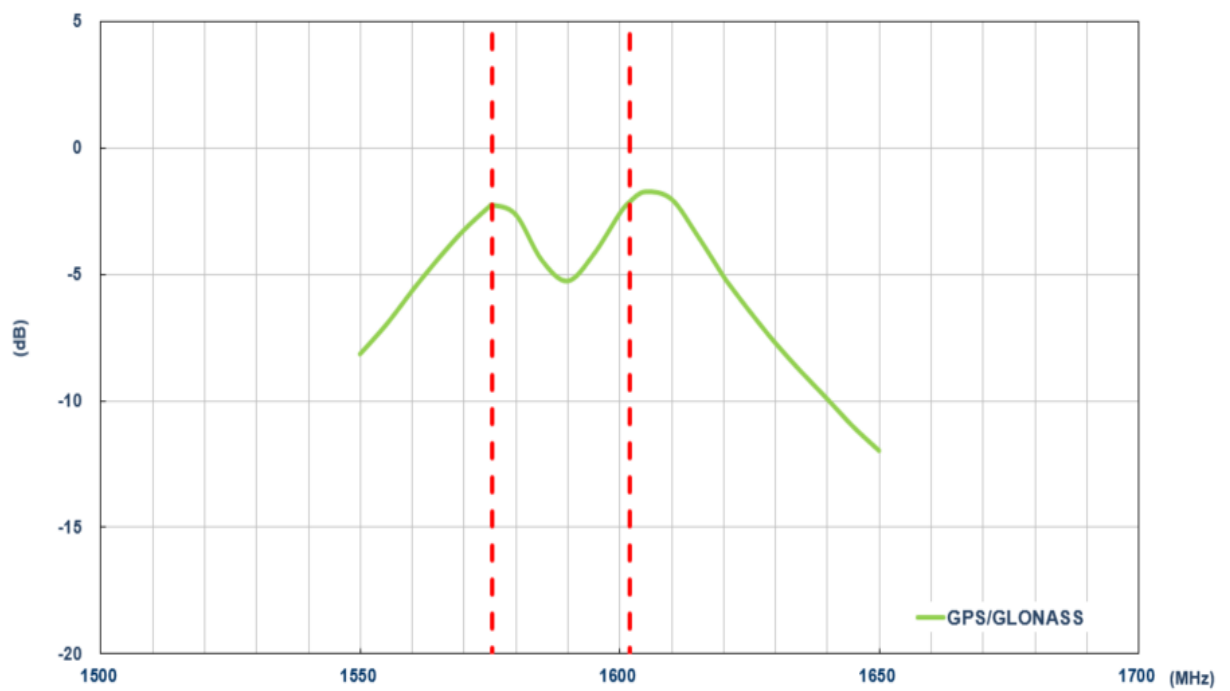

3.13 GNSS Antenna – Peak Gain (Passive Measurement)

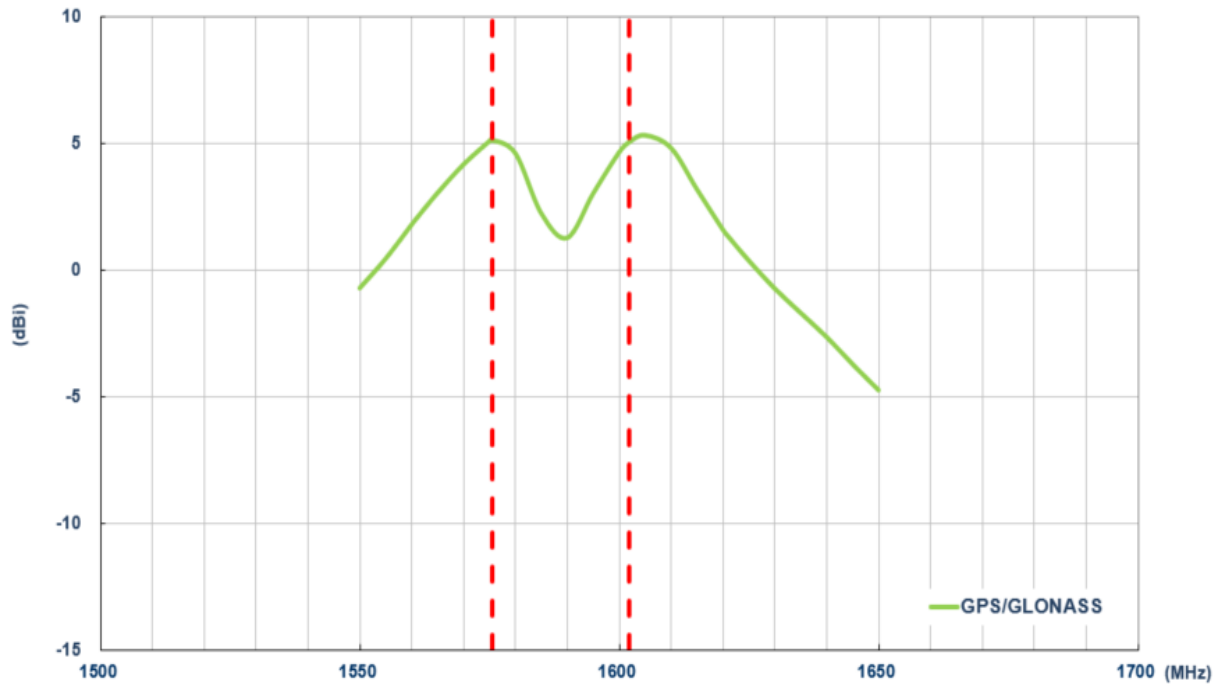

3.14 GNSS Antenna – Axial Ratio (Zenith is at 0°)

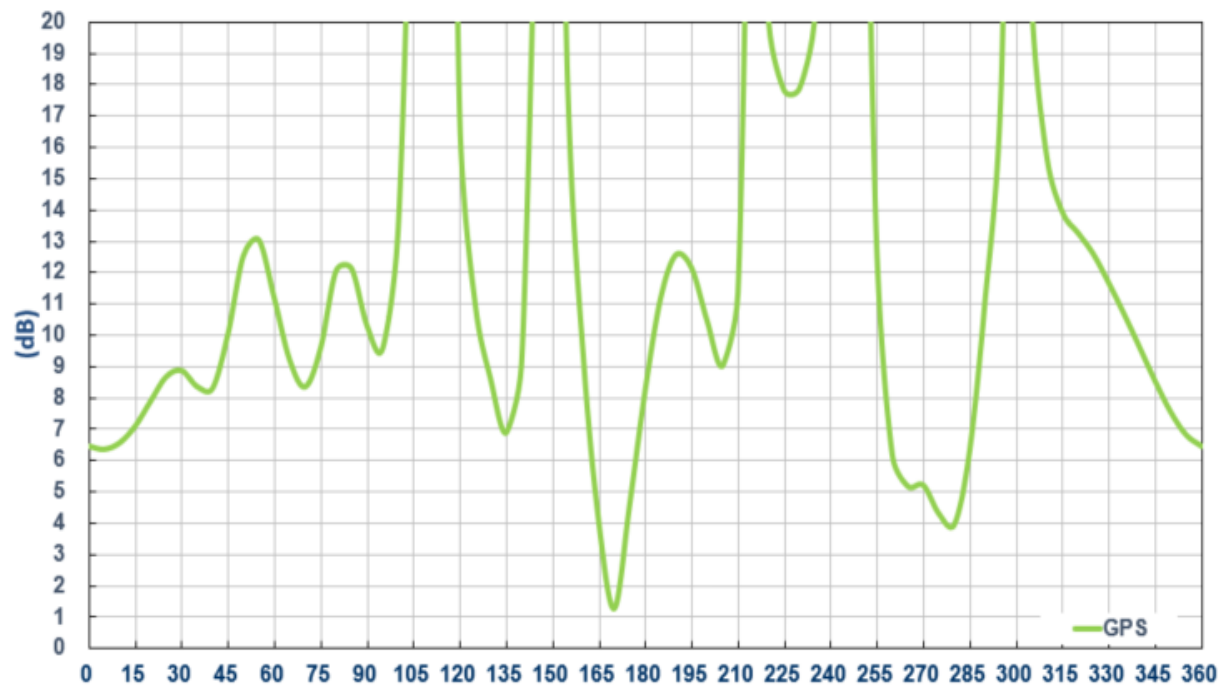

Axial Ratio at GPS L1 (1575.42MHz)

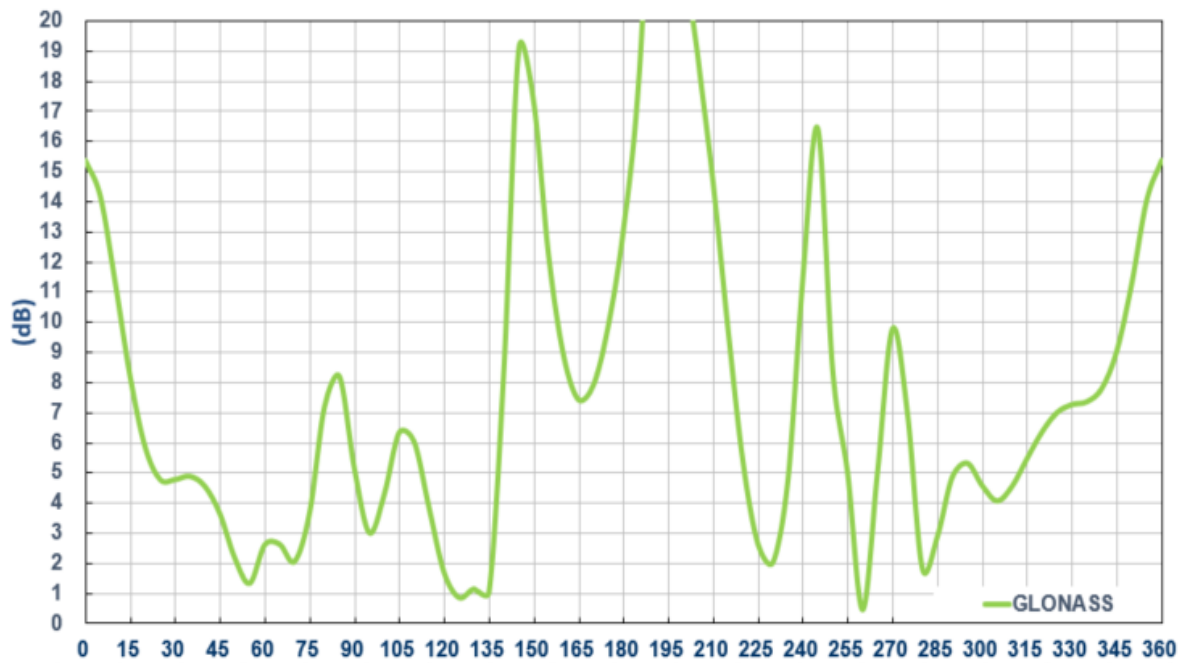

Axial Ratio at GLONASS L1 (1602MHz)

3.14 GNSS Antenna – Active Measurements

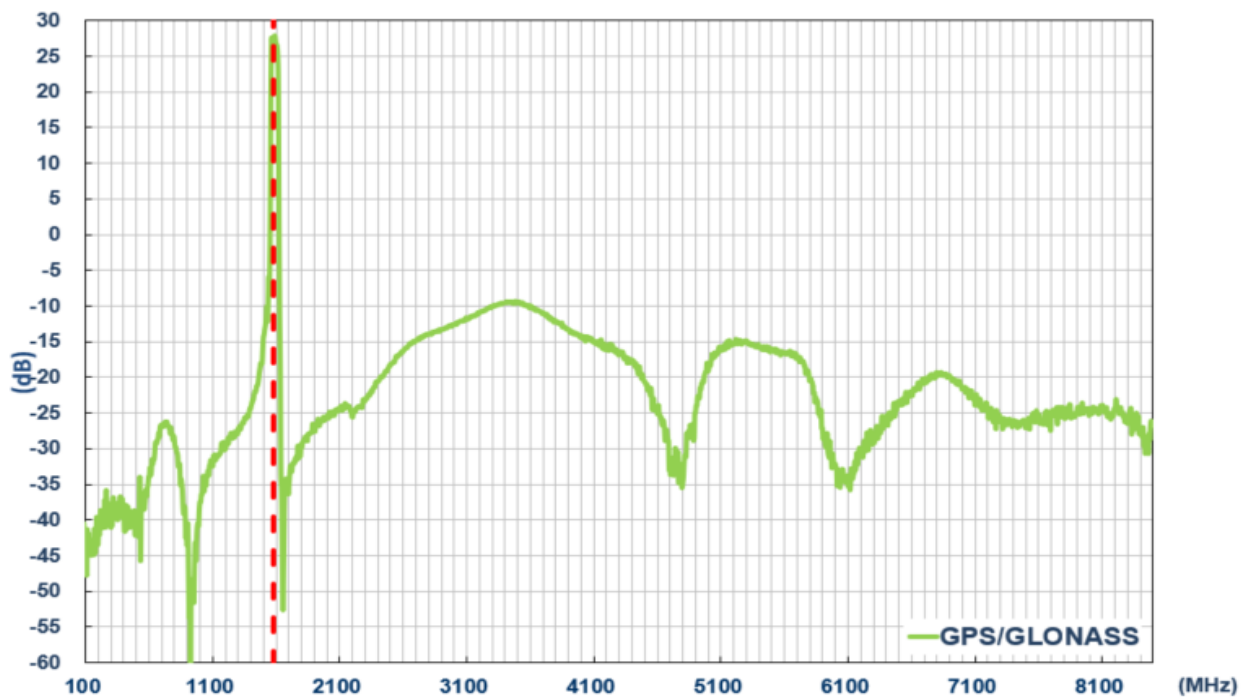

LNA Gain @ 3.0V

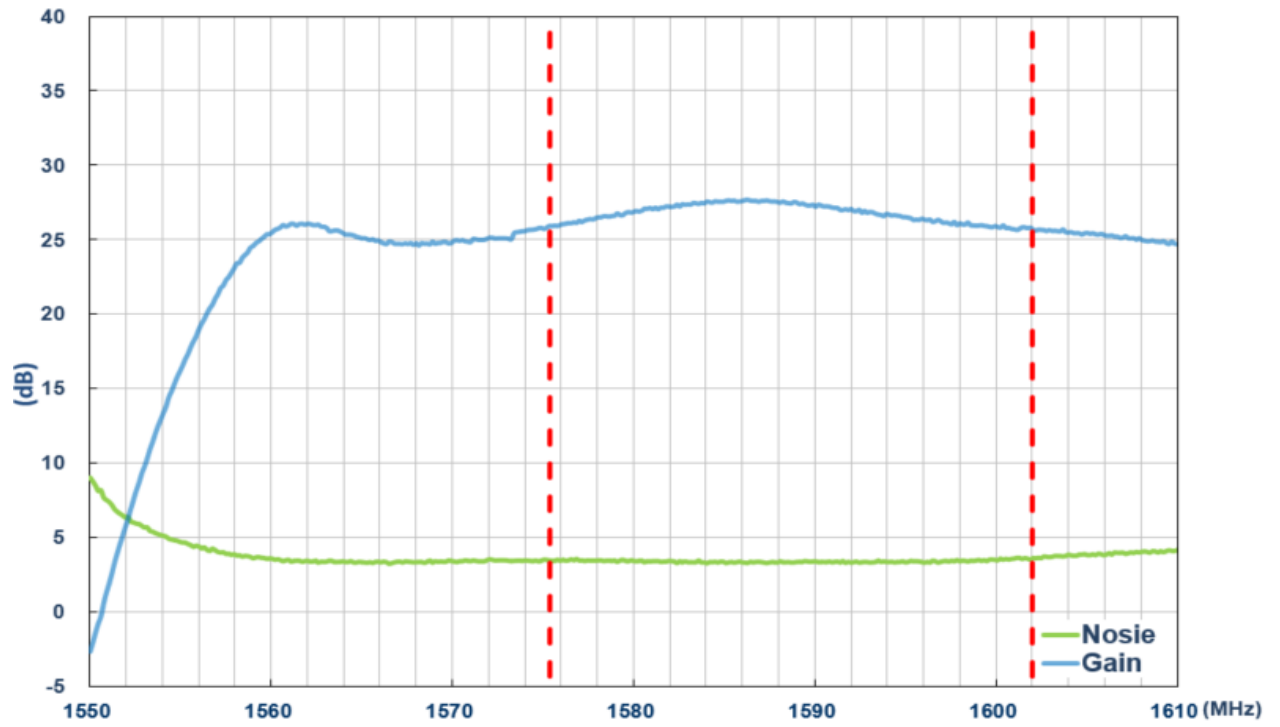

LNA Gain and Noise Figure @ 3.0V

4. Radiation Patterns

4.1 Test Setup



Free space



On 30*30cm GND

4.2 2D & 3D Radiation Patterns – Free space

617MHz

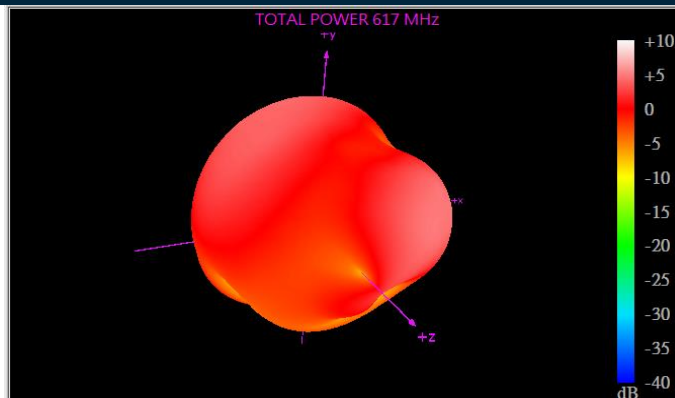

XY Plane

XZ Plane

YZ Plane

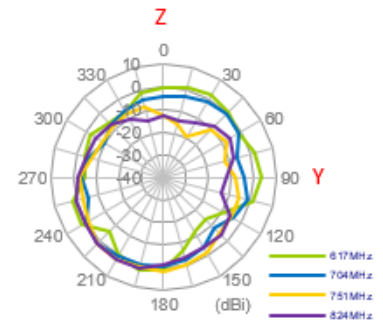
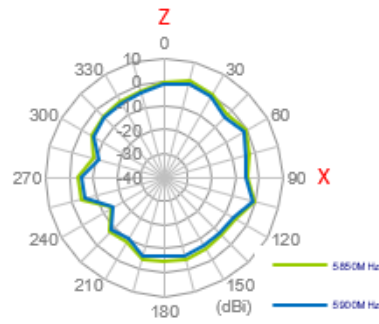
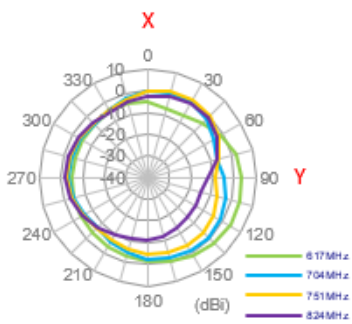

704MHz

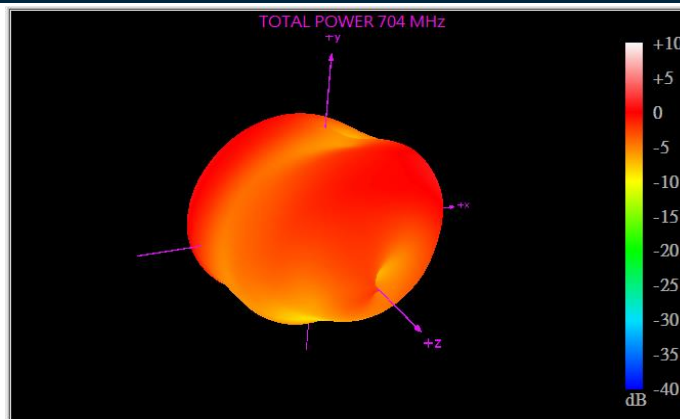

XY Plane

XZ Plane

YZ Plane

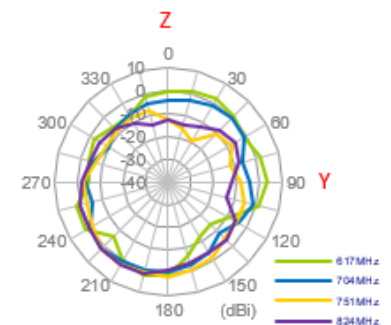
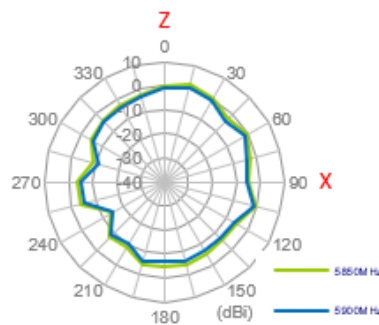
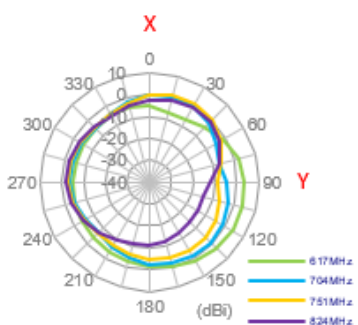

960MHz

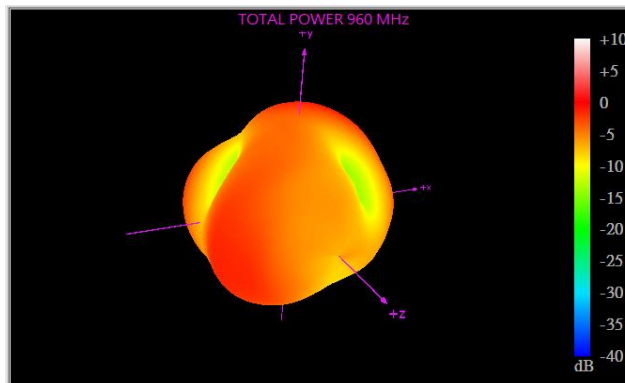

XY Plane

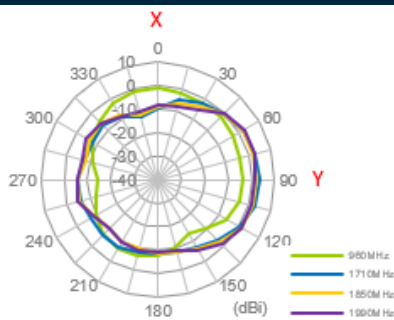

XZ Plane

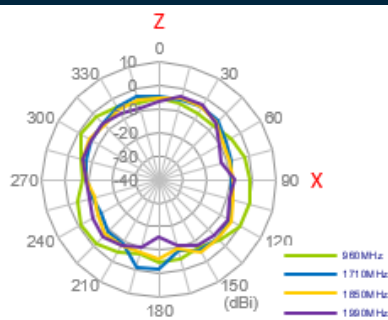

YZ Plane

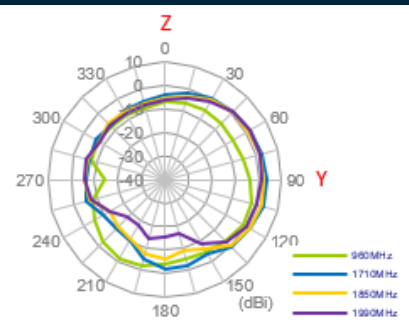

1710MHz

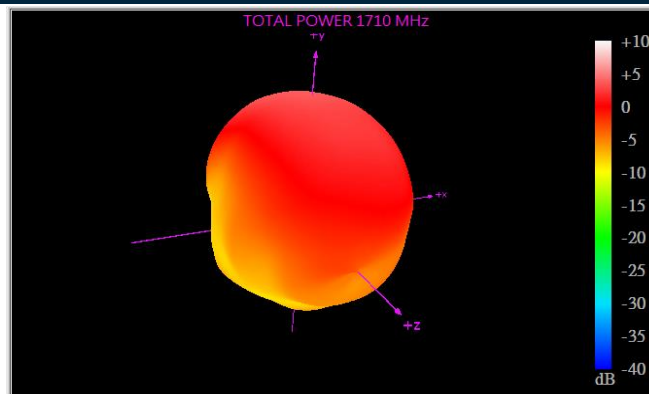

XY Plane

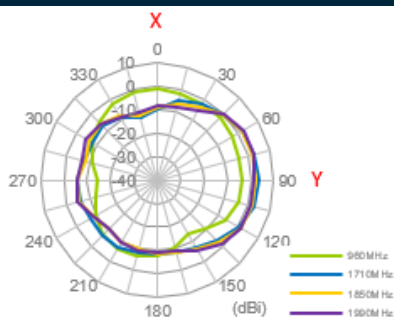

XZ Plane

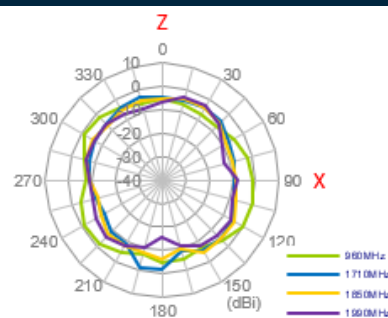

YZ Plane

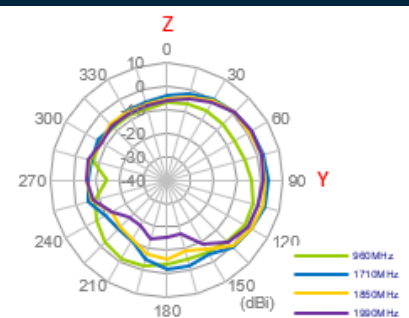

1850MHz

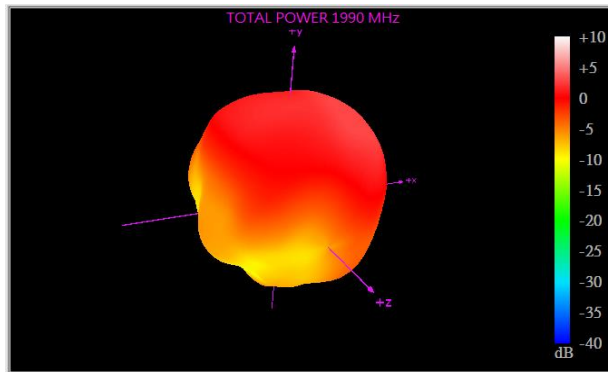

XY Plane

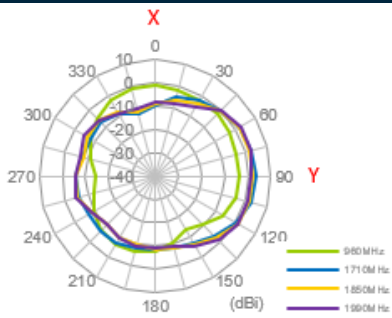

XZ Plane

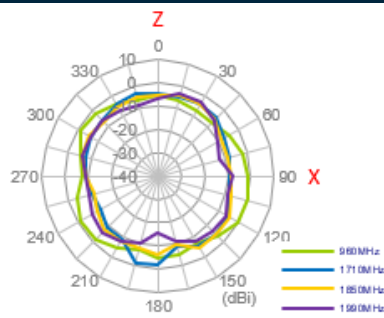

YZ Plane

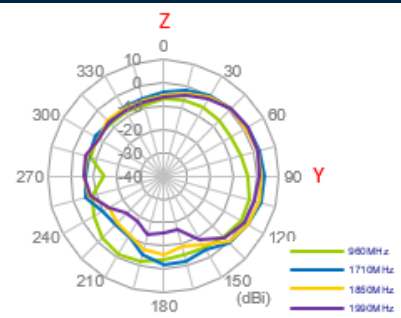

1990MHz

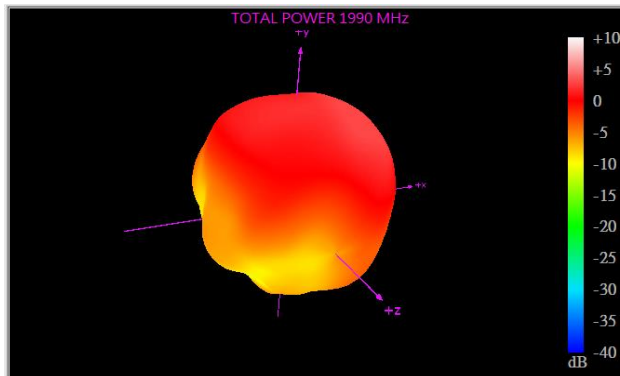

XY Plane

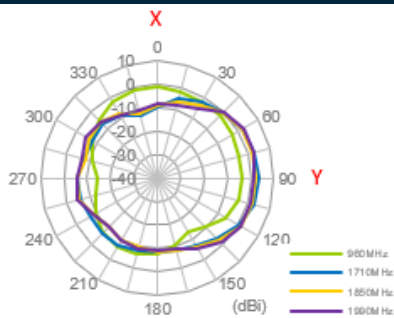

XZ Plane

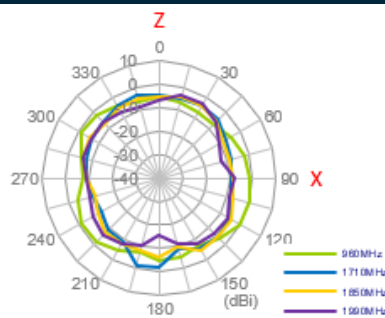

YZ Plane

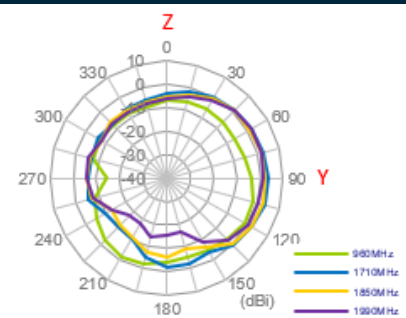

2170MHz

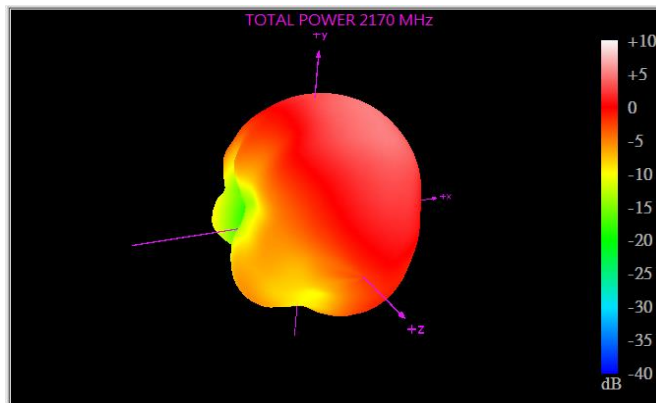

XY Plane

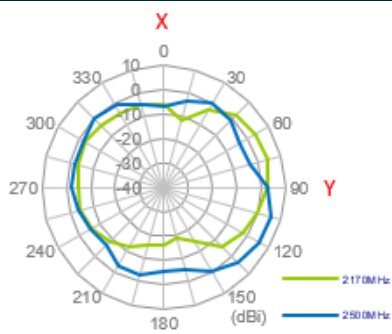

XZ Plane

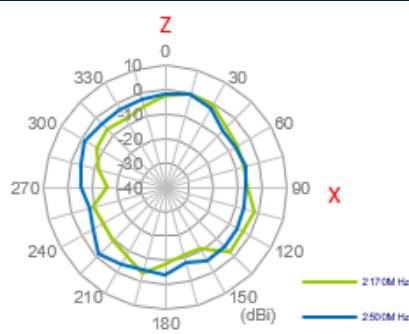

YZ Plane

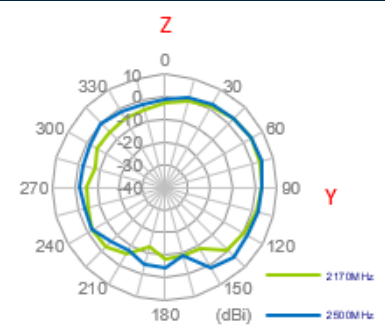

2500MHz

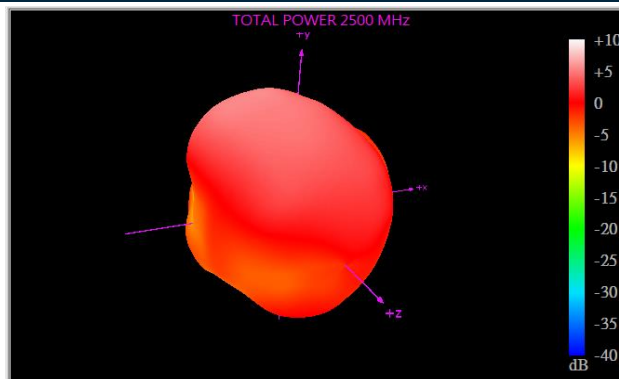

XY Plane

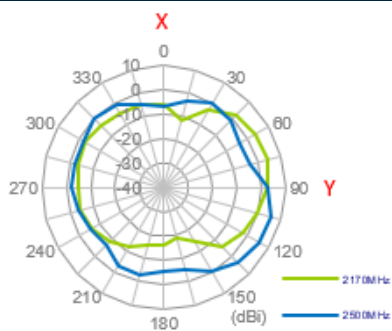

XZ Plane

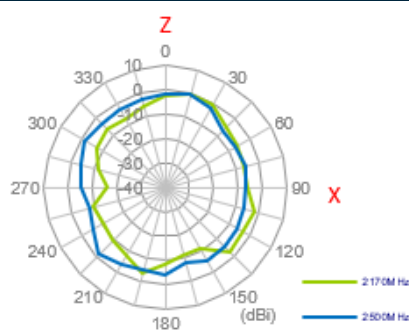

YZ Plane

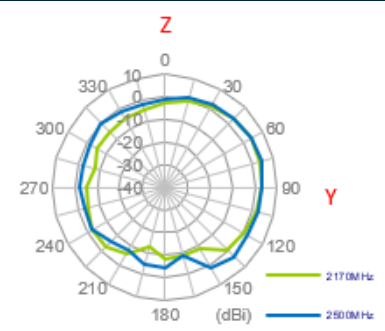

2690MHz

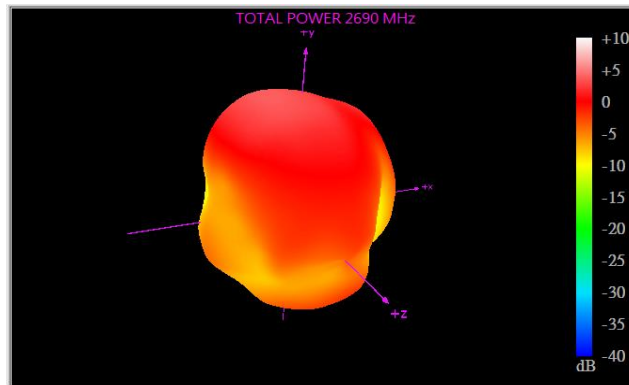

XY Plane

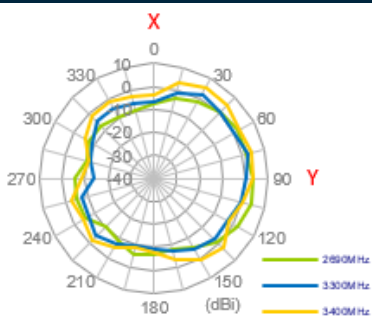

XZ Plane

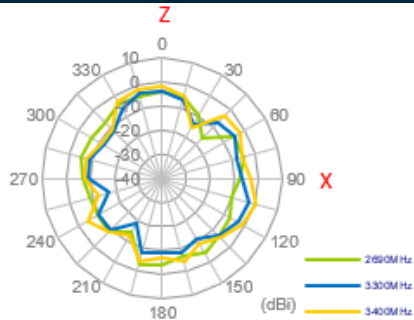

YZ Plane

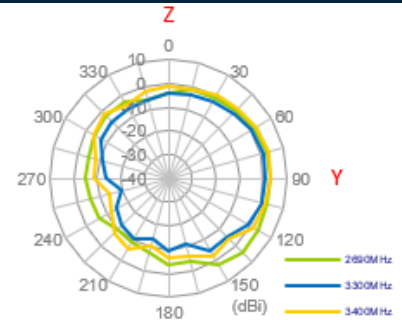

3300MHz

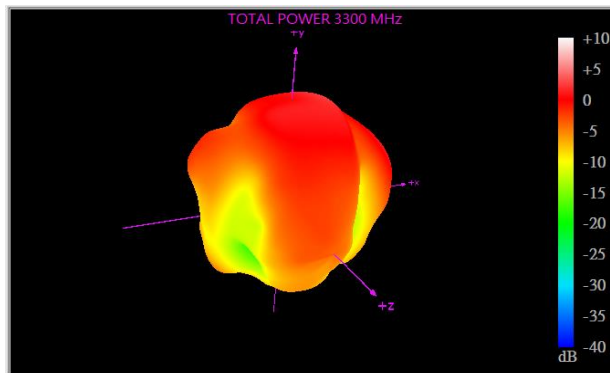

XY Plane

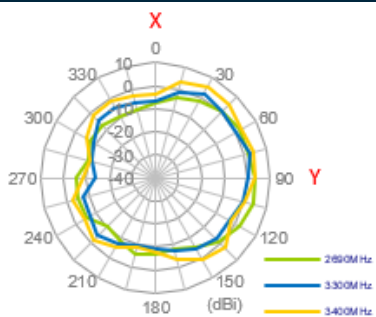

XZ Plane

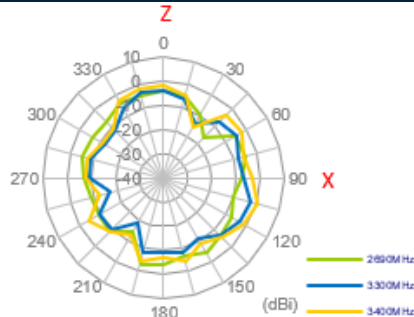

YZ Plane

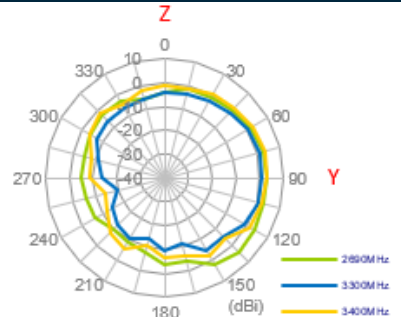

3400MHz

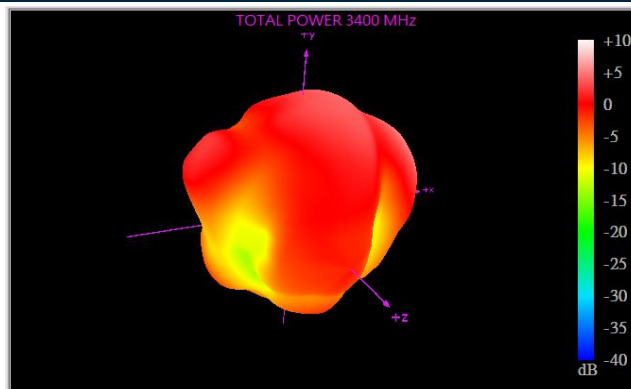

XY Plane

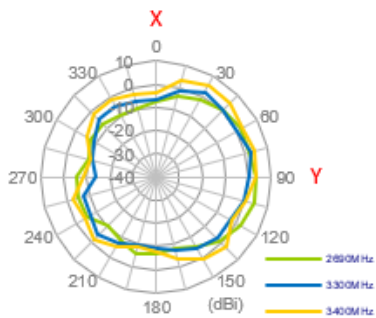

XZ Plane

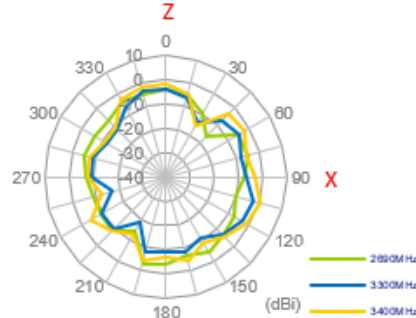

YZ Plane

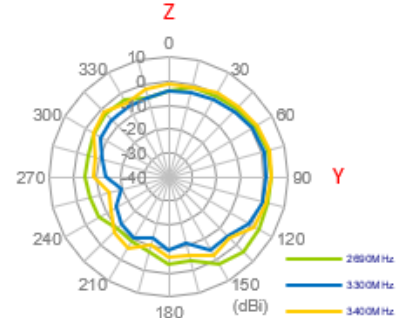

5150MHz

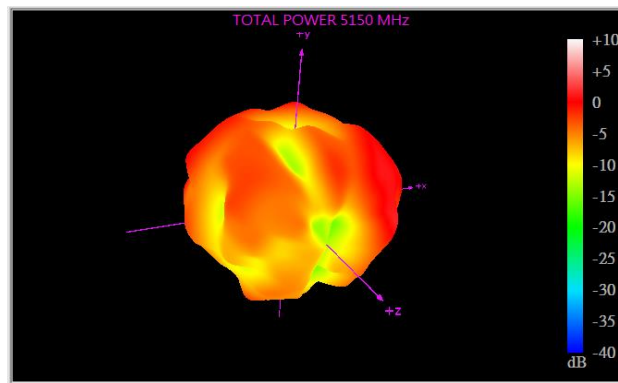

XY Plane

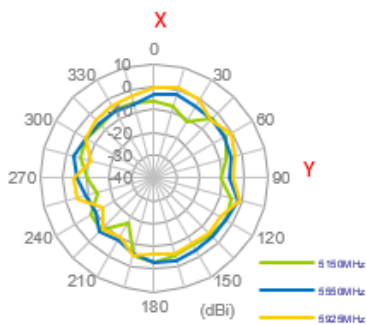

XZ Plane

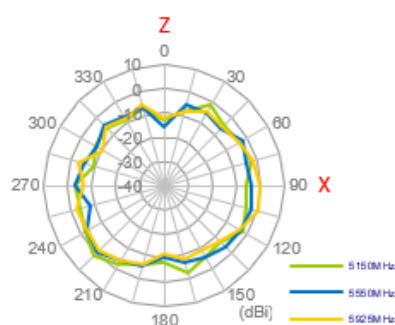

YZ Plane

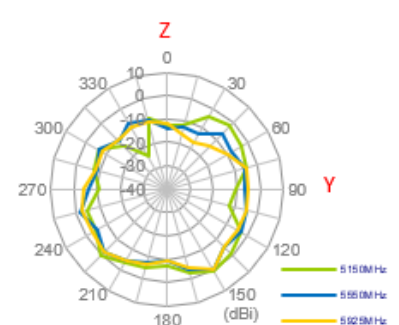

5550MHz

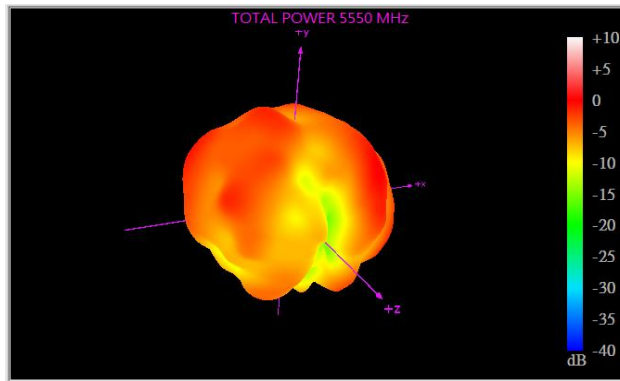

XY Plane

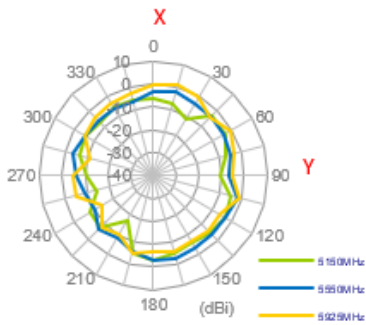

XZ Plane

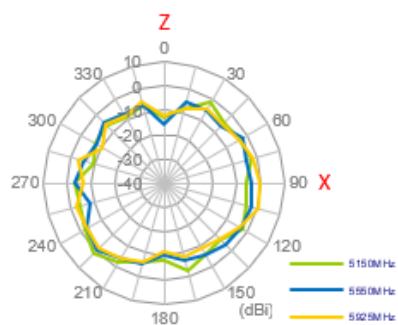

YZ Plane

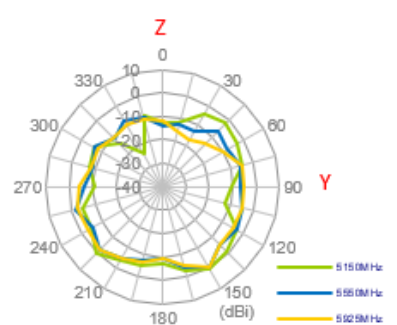

5925MHz

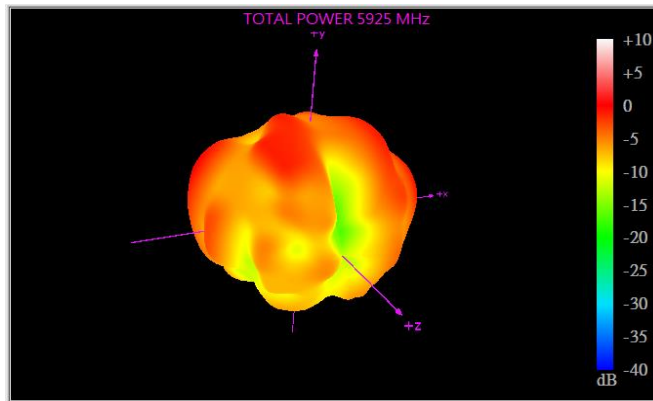

XY Plane

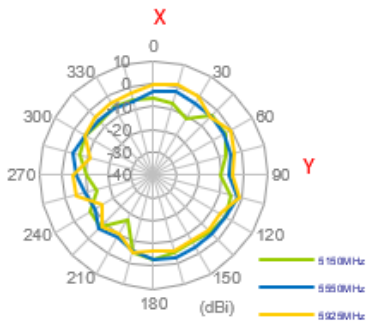

XZ Plane

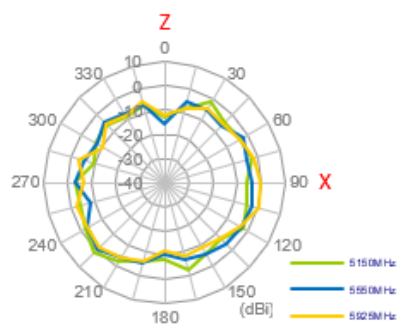

YZ Plane

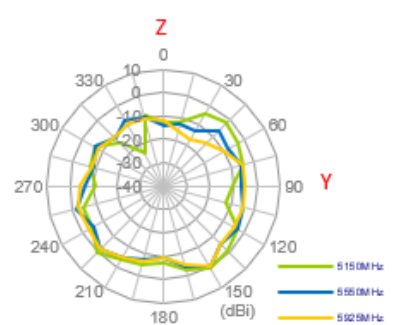

1561MHz (GNSS)

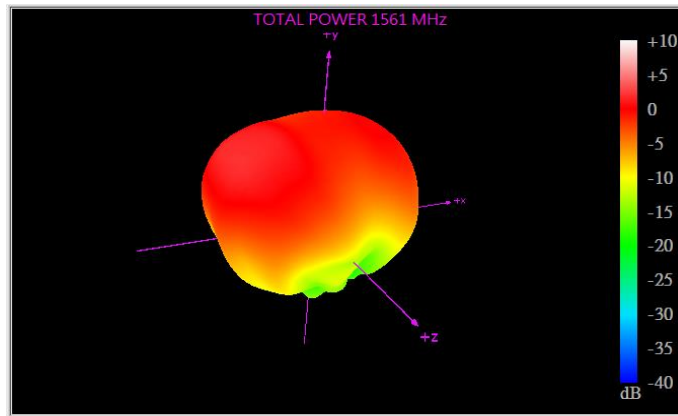

XY Plane

XZ Plane

YZ Plane

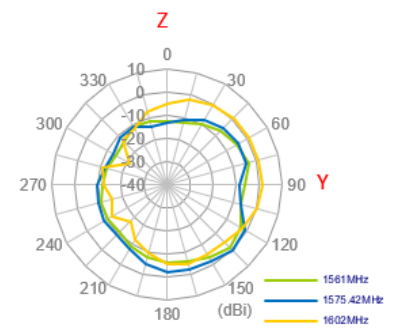
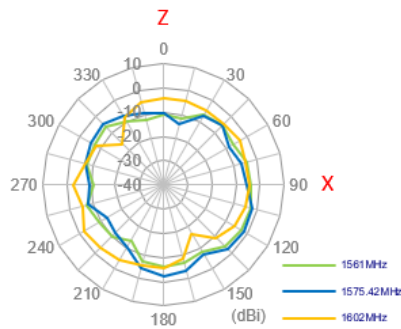
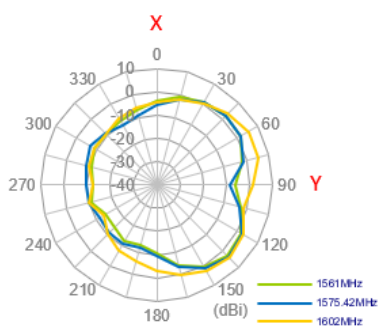

1575.42MHz (GNSS)

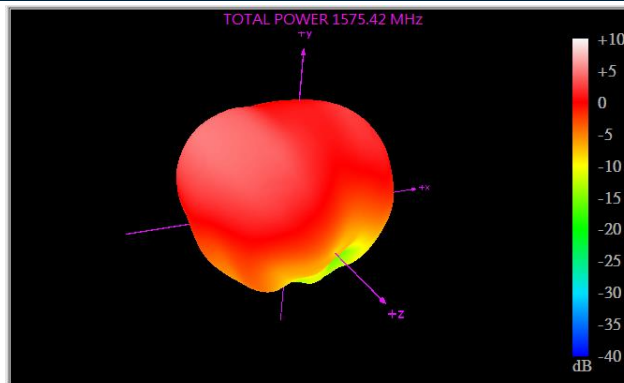

XY Plane

XZ Plane

YZ Plane

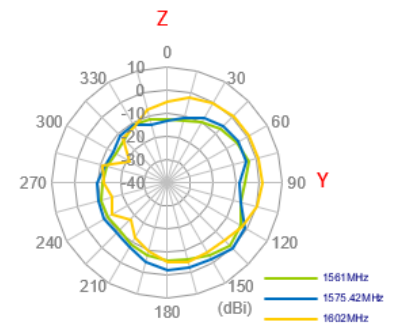
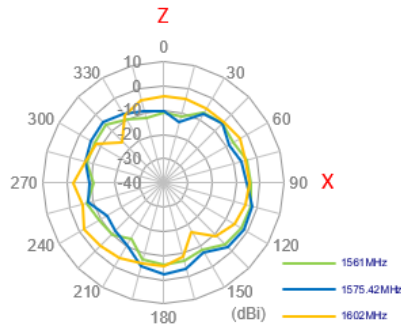
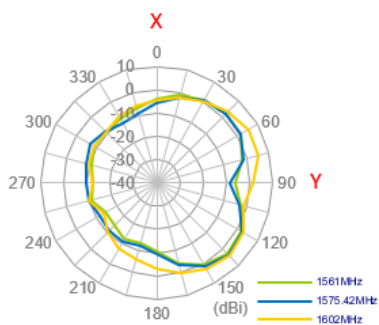

1602MHz (GNSS)

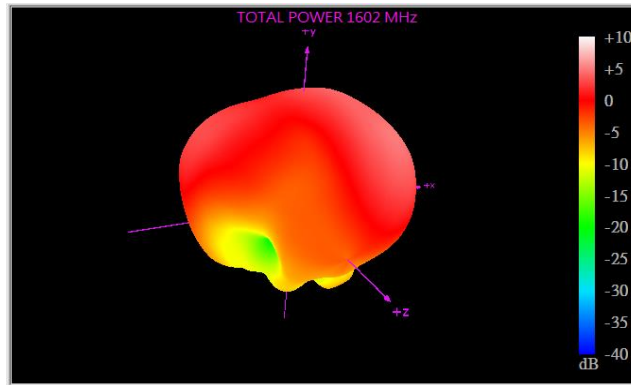

XY Plane

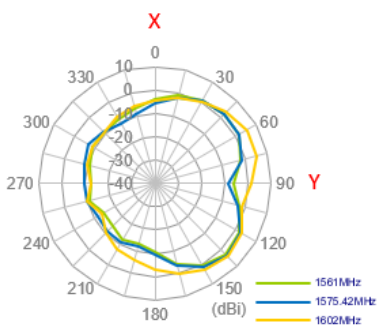

XZ Plane

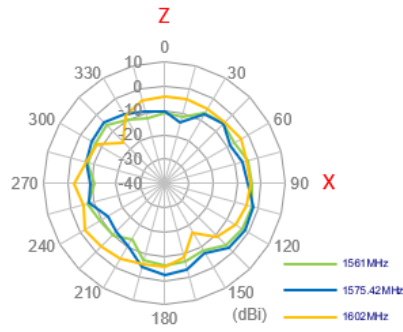

YZ Plane

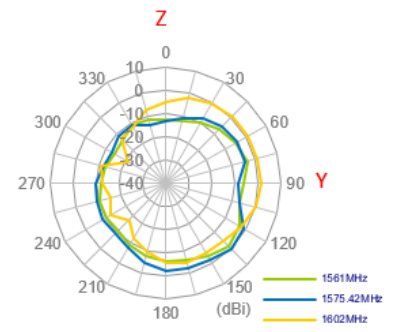

5. Mechanical Drawing (Units: mm)

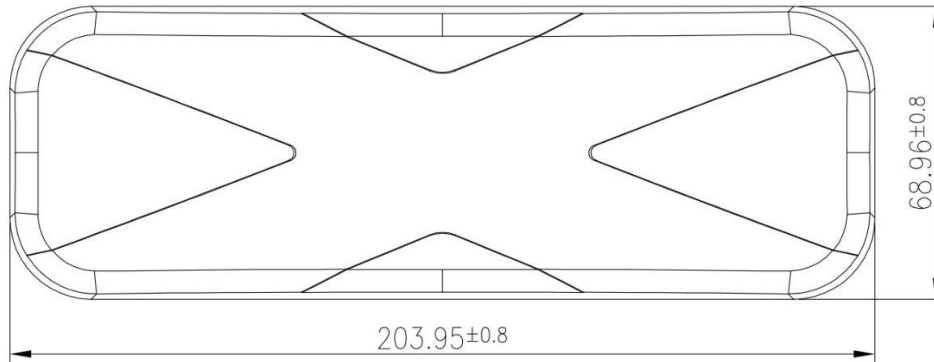

Bottom Thread View

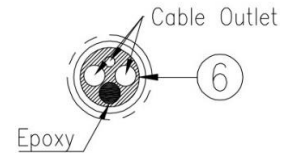

Front View

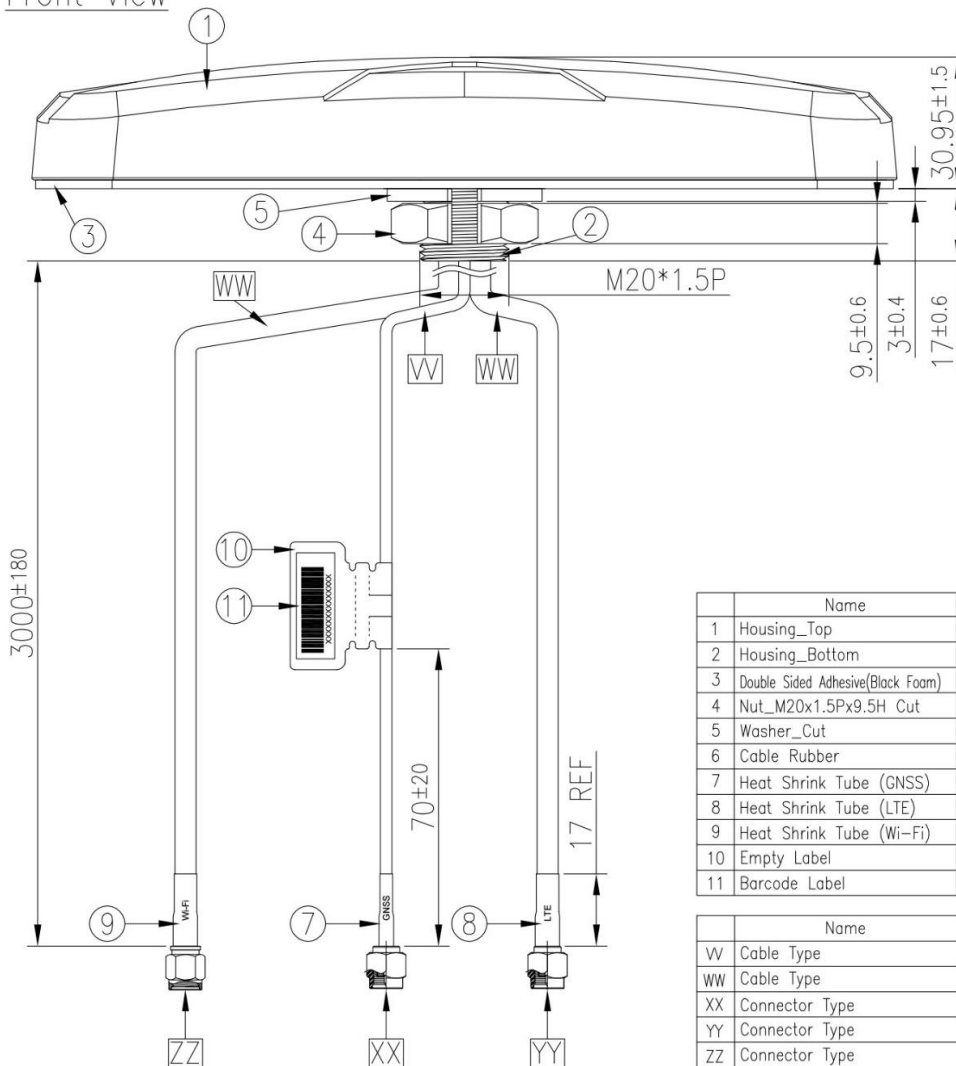

Name	Material	Finish	QTY
1 Housing_Top	ABS+PC	Black	1
2 Housing_Bottom	ABS+PC	Black	1
3 Double Sided Adhesive(Black Foam)	3M 9448HK+CR4305	White Liner	1
4 Nut_M20x1.5Px9.5H Cut	Steel	Ni-Zn Plated	1
5 Washer_Cut	Steel	Ni-Zn Plated	1
6 Cable Rubber	Silicone Rubber	Black	1
7 Heat Shrink Tube (GNSS)	PE	Blue Tube/White Text	1
8 Heat Shrink Tube (LTE)	PE	Red Tube/White Text	1
9 Heat Shrink Tube (Wi-Fi)	PE	Yellow Tube/Black Text	1
10 Empty Label	PEPA	White	1
11 Barcode Label	PET	White	1

Name	SPEC	Finish	QTY
W Cable Type	RG174	Black	1
WW Cable Type	CFD200	Black	2
XX Connector Type	SMA(M)ST	Au Plated	1
YY Connector Type	SMA(M)ST	Au Plated	1
ZZ Connector Type	RP-SMA(M)ST	Au Plated	1

6. Packaging

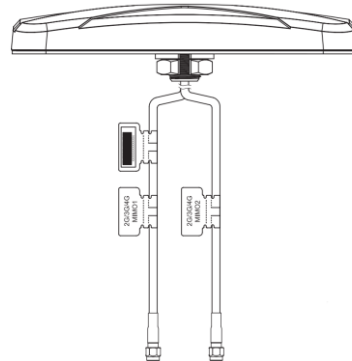

16 pcs MA172.A.LBC.001 per carton
 Carton Dimensions 506*490*250mm
 Total Weight: 9.7g

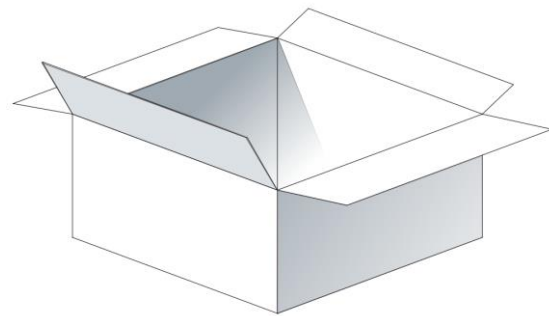

Carton top view

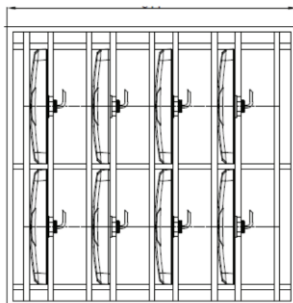

Carton top view

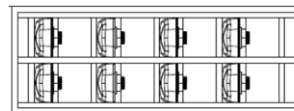

Pallet Dimensions 1200*1000*1450mm
 20 Cartons per pallet
 4 Cartons per layers
 5 Layers

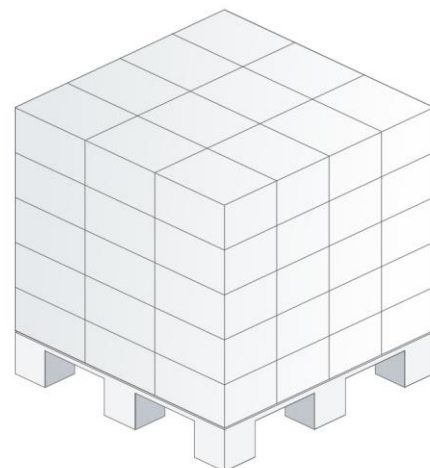

Changelog for the datasheet

SPE-18-8-090 - MA172.A.LBC.001

Revision: C (Current Version)

Date:	2022-10-28
Notes:	Updated packaging information
Author:	Cesar Sousa

Previous Revisions

Revision: B

Date:	2021-10-27
Notes:	Full datasheet template update with new data.
Author:	Gary West

Revision: A (Original First Release)

Date:	2018-10-22
Notes:	
Author:	Jack Conroy



TAOGLAS®

www.taoglas.com

