

Maswell Cellular Antenna 5G 4G WiFi6 Screw And 3M Adhesive Mount UV Stabilized IP67

AN_GSM_401

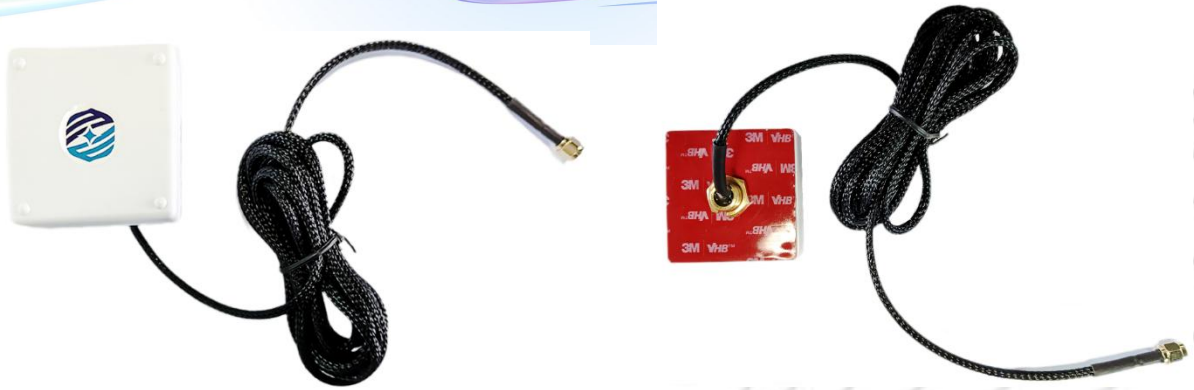

Mechanical Dimension

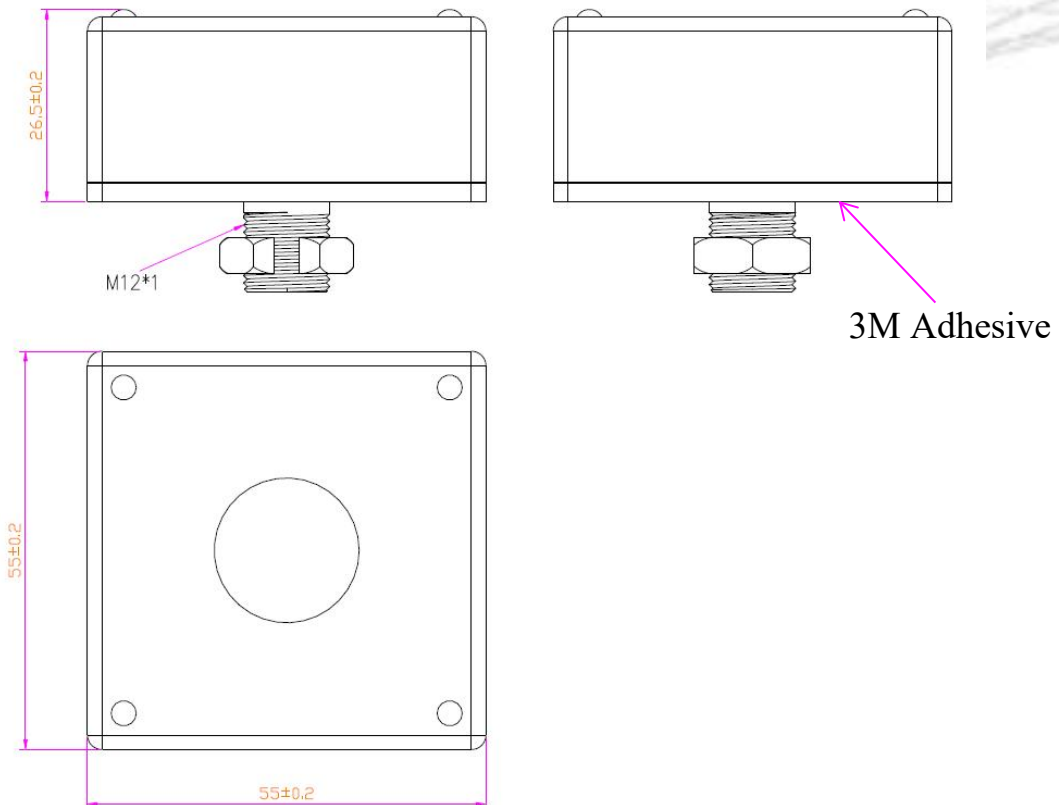

Maswell Cellular Antenna 5G 4G WiFi6 Screw And 3M Adhesive Mount UV Stabilized IP67

AN_GSM_401

Specifications

Item	Specifications	
Antenna	Frequency Range	700-6000Mhz
	Polarization	Linear
	Gain	5dBi Maximum
	V.S.W.R	<1.5
	Impedance	50Ω
	Dimension	55 *55 *26.5mm
Mechanical	Cable	RG174 (3M)
	Connector	SMA
	Radome Material	ASA UV Stabilized
	Mounting Method	Screw+3M Adhesive
Environmental	Operating Temperature	-40°C~+85°C
	Relative Humidity	Up to 95%
	Waterproof	IP67 (EURO: EN 60529:1991+A1:2000+A2:2013+AC:2019 CHINA: GB/T4208-2017)
	Vibration	10 to 55Hz with 1.5mm amplitude 2hours
	Environmentally Friendly	ROHS Compliant
	UV Stabilized	YES

Installation Guide

- ❖ Please use the supplied L plate for installation.
- ❖ If L plate is too large to fit the installation, please mount the antenna on a metal surface with minimum 56mm*56mm dimension. Performances may be affected at low frequency band.
- ❖ Preferred metal surface dimension is 100mm*100mm, if L plate is not installed.

Suzhou maswell communication technology co. Ltd

Add: Floor 3, Building 6, No. 88 Zhenbei Road, High-tech District, Suzhou 215153, Jiangsu, China

Http ://www.maswelltech.com

E-mail: Sales@maswelltech.com

Maswell Cellular Antenna 5G 4G WiFi6 Screw And 3M Adhesive Mount UV Stabilized IP67

AN_GSM_401

Measured Results

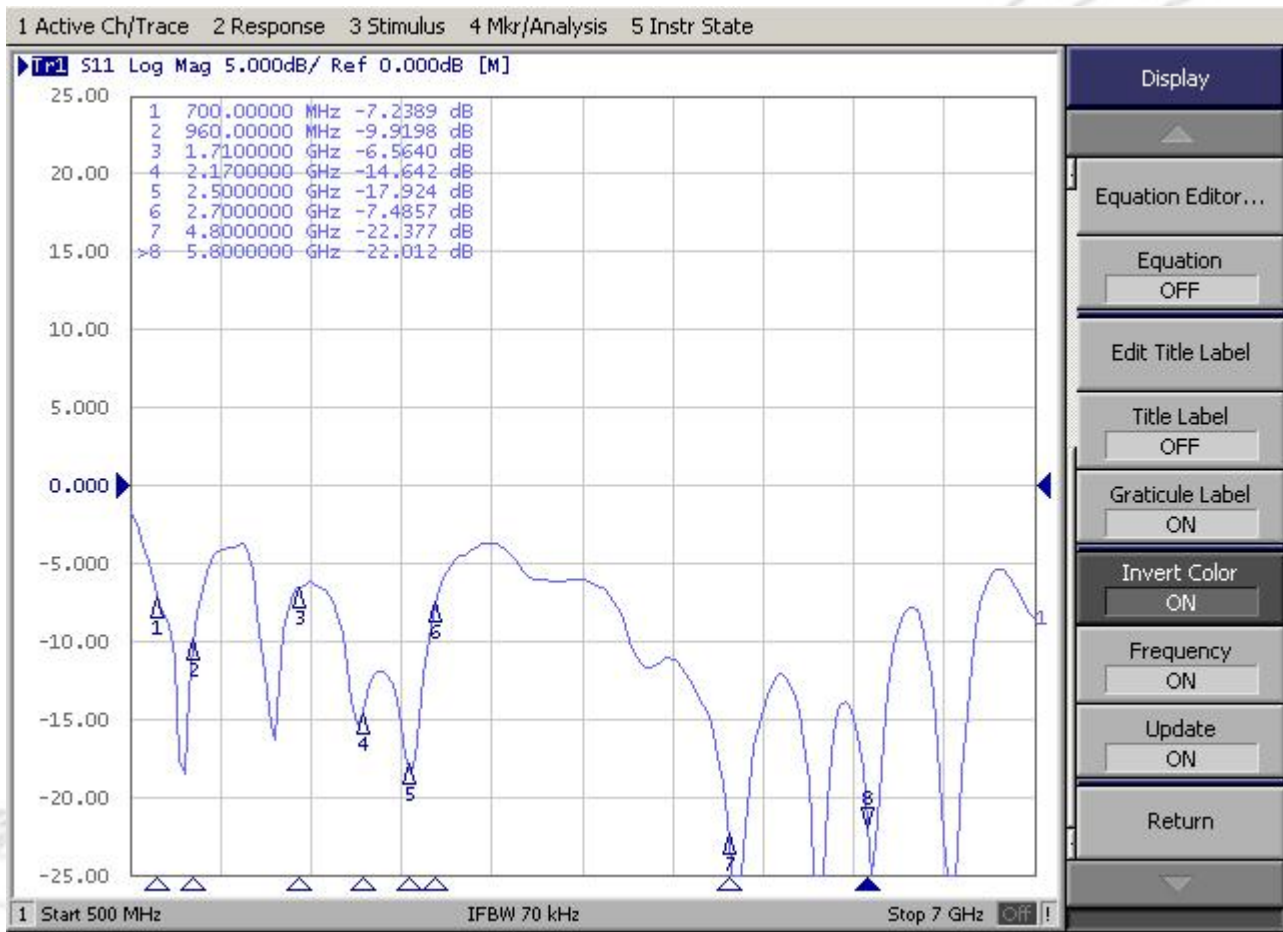

Maswell Cellular Antenna 5G 4G WiFi6 Screw And 3M Adhesive Mount UV Stabilized IP67

AN_GSM_401

Measured Data

Passive Test For 600-6000		
Freq (MHz)	Effi (%)	Gain (dBi)
600	24.18	-1.98
650	28.66	-2.64
700	38.42	-0.03
750	56.43	-0.28
800	62.93	2.3
850	59.67	0.41
900	56.84	0.89
950	46.23	0.78
1000	48	2.11
1050	54.69	3.47
1100	45.41	2.14
1150	31.19	0.45
1200	24.71	-2.53
1250	22.83	-3.22
1300	20.94	-3.43
1350	24.62	-1.49
1400	28.01	-0.77
1450	40.75	0.16
1500	39.39	-0.8
1550	43.11	-0.65
1600	50.35	1.08
1650	54.81	0.94
1700	46.27	1.52
1750	47.97	0.75
1800	47.78	1.03
1850	53.33	1.81
1900	66.26	3.26
1950	66.14	4.01
2000	64	3.87
2050	65.18	4.29
2100	68.07	4.56
2150	52.51	3.63
2200	51.88	3.52
2250	55.44	3.62

Passive Test For 600-6000		
2300	59.35	4.23
2350	63.99	4.7
2400	63.95	4.55
2450	59.72	4.65
2500	64.69	4.45
2550	60.8	4.11
2600	57.3	4.05
2650	55.94	3.94
2700	51.22	3.52
2750	47.38	3.43
2800	61.15	4.92
2850	56.43	5.05
2900	51.58	4.85
2950	50.25	5.12
3000	49.22	5.07
3050	49.62	5.15
3100	54.6	5.55
3150	54.15	5.25
3200	60.86	5.69
3250	66.65	6.15
3300	71.28	6.33
3350	78.36	6.39
3400	78.3	6.09
3450	74.56	5.66
3500	68.58	5.35
3550	65.7	5.11
3600	68.4	5.36
3650	68.61	5.37
3700	62.37	4.67
3750	62.4	4.66
3800	58.95	4.59
3850	62.41	4.72
3900	68.67	5.11
3950	70.61	5.17
4000	77.22	5.36
4050	76.74	5.24
4100	76.44	5.11

Passive Test For 600-6000		
4150	79.19	5.15
4200	74.83	4.82
4250	74.42	4.58
4300	73.49	4.69
4350	68.53	4.32
4400	70.95	4.43
4450	68.01	4.15
4500	70.9	4.33
4550	69.68	4.22
4600	63.7	3.89
4650	65.16	4.09
4700	64.52	4.12
4750	60.22	4.02
4800	62.13	4.31
4850	56.51	3.93
4900	55.12	3.86
4950	51.97	3.56
5000	51.65	3.44
5050	46.26	2.77
5100	47.85	2.76
5150	45.8	2.27
5200	44.69	2.01
5250	49.25	2.39
5300	49.25	2.45
5350	53.34	3
5400	55.58	3.25
5450	52.45	3.19
5500	51.66	3.28
5550	52.37	3.65
5600	52.08	3.7
5650	53.99	3.85
5700	55.02	4.1
5750	56.92	4.23
5800	54.19	4.15
5850	56.85	4.46
5900	51.74	4.17
5950	65.46	5.12
6000	62.48	4.29

Maswell Cellular Antenna 5G 4G WiFi6 Screw
And 3M Adhesive Mount UV Stabilized IP67

AN_GSM_401

700Mhz

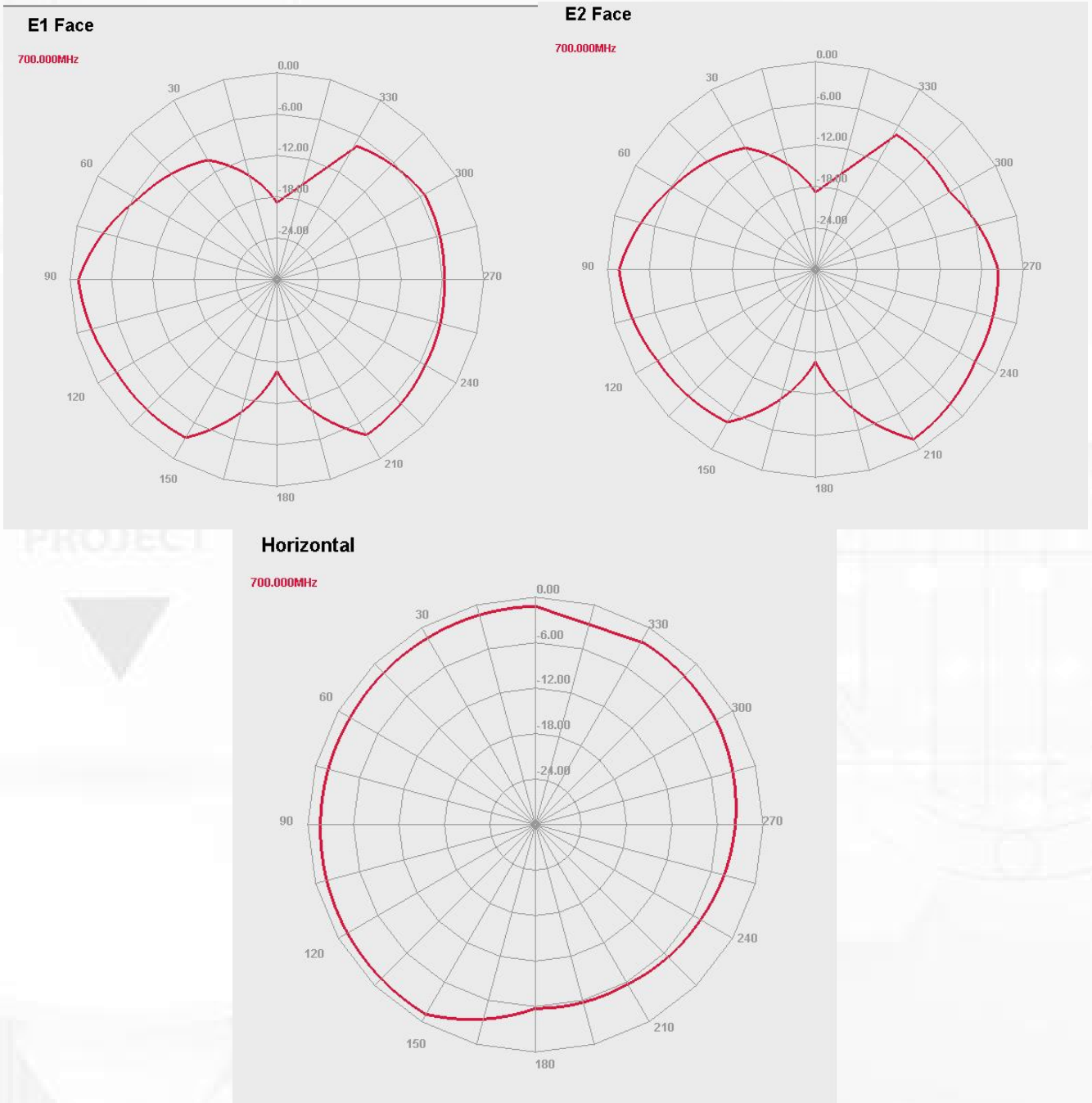

Maswell Cellular Antenna 5G 4G WiFi6 Screw
And 3M Adhesive Mount UV Stabilized IP67

AN_GSM_401

1800Mhz

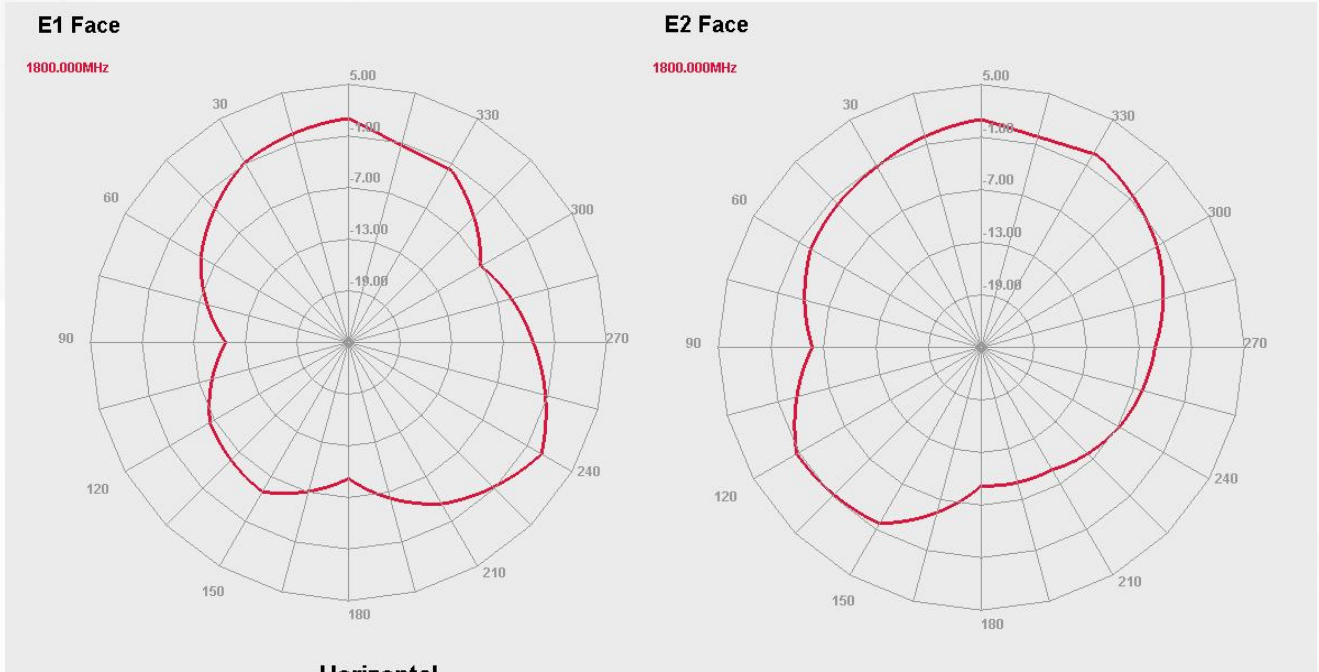

Horizontal

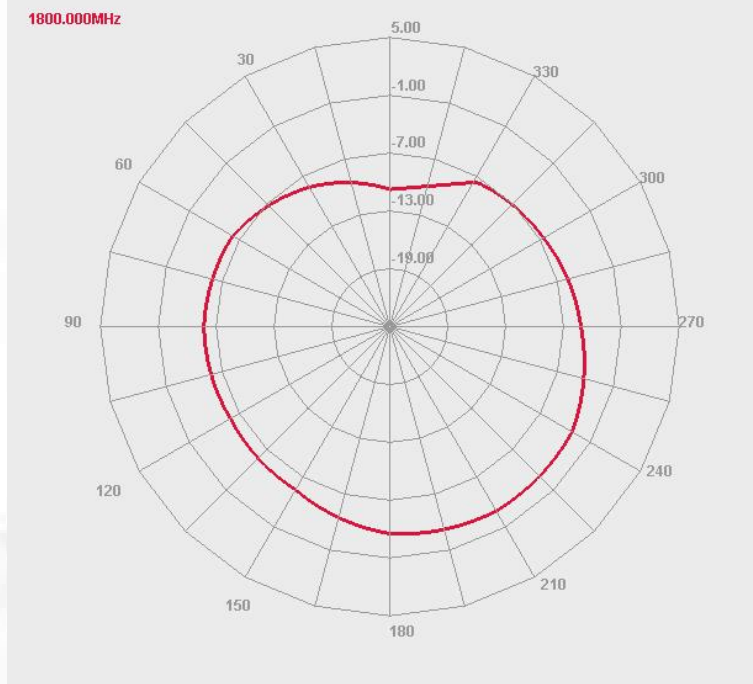

Maswell Cellular Antenna 5G 4G WiFi6 Screw
And 3M Adhesive Mount UV Stabilized IP67

AN_GSM_401

2600Mhz

E1 Face

2600.000MHz

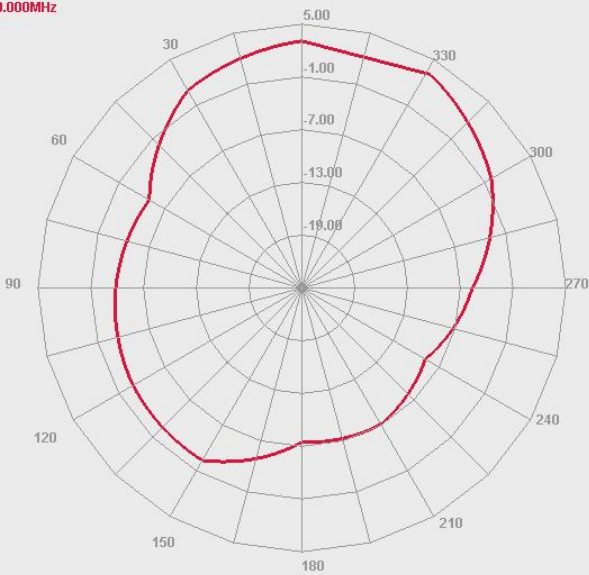

E2 Face

2600.000MHz

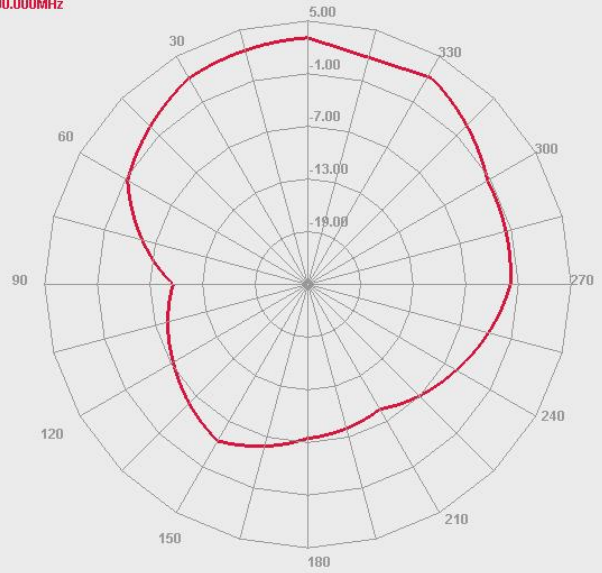

Horizontal

2600.000MHz

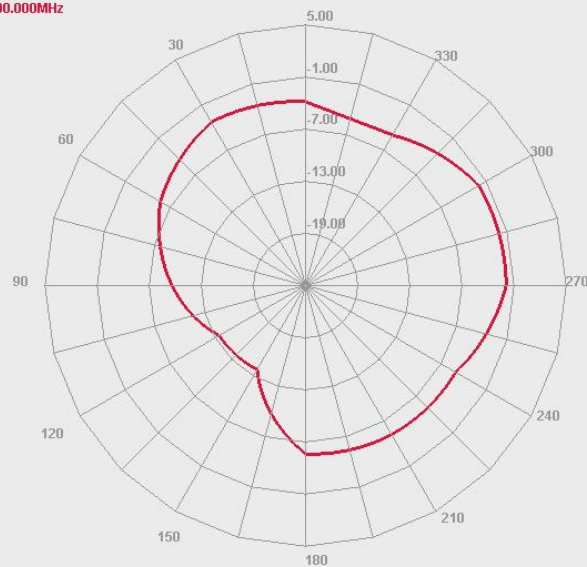

Maswell Cellular Antenna 5G 4G WiFi6 Screw And 3M Adhesive Mount UV Stabilized IP67

AN_GSM_401

3500Mhz

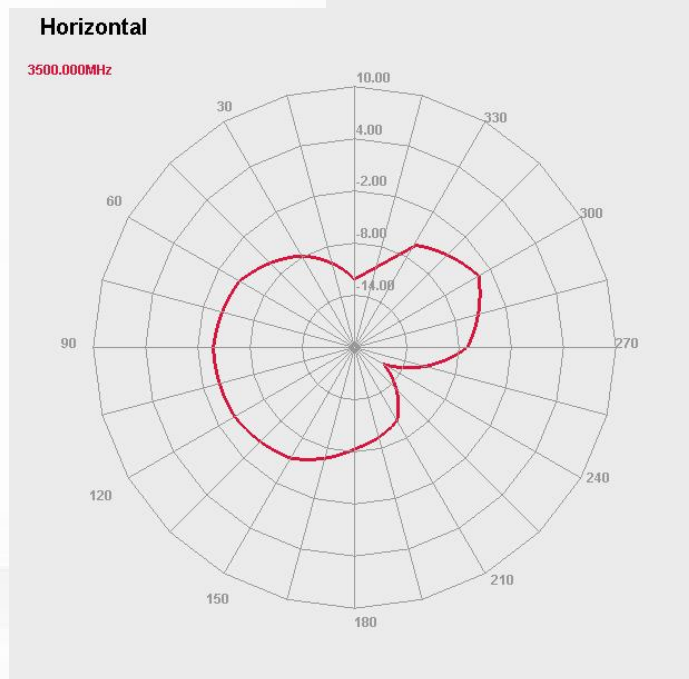

Maswell Cellular Antenna 5G 4G WiFi6 Screw And 3M Adhesive Mount UV Stabilized IP67

AN_GSM_401

4800Mhz

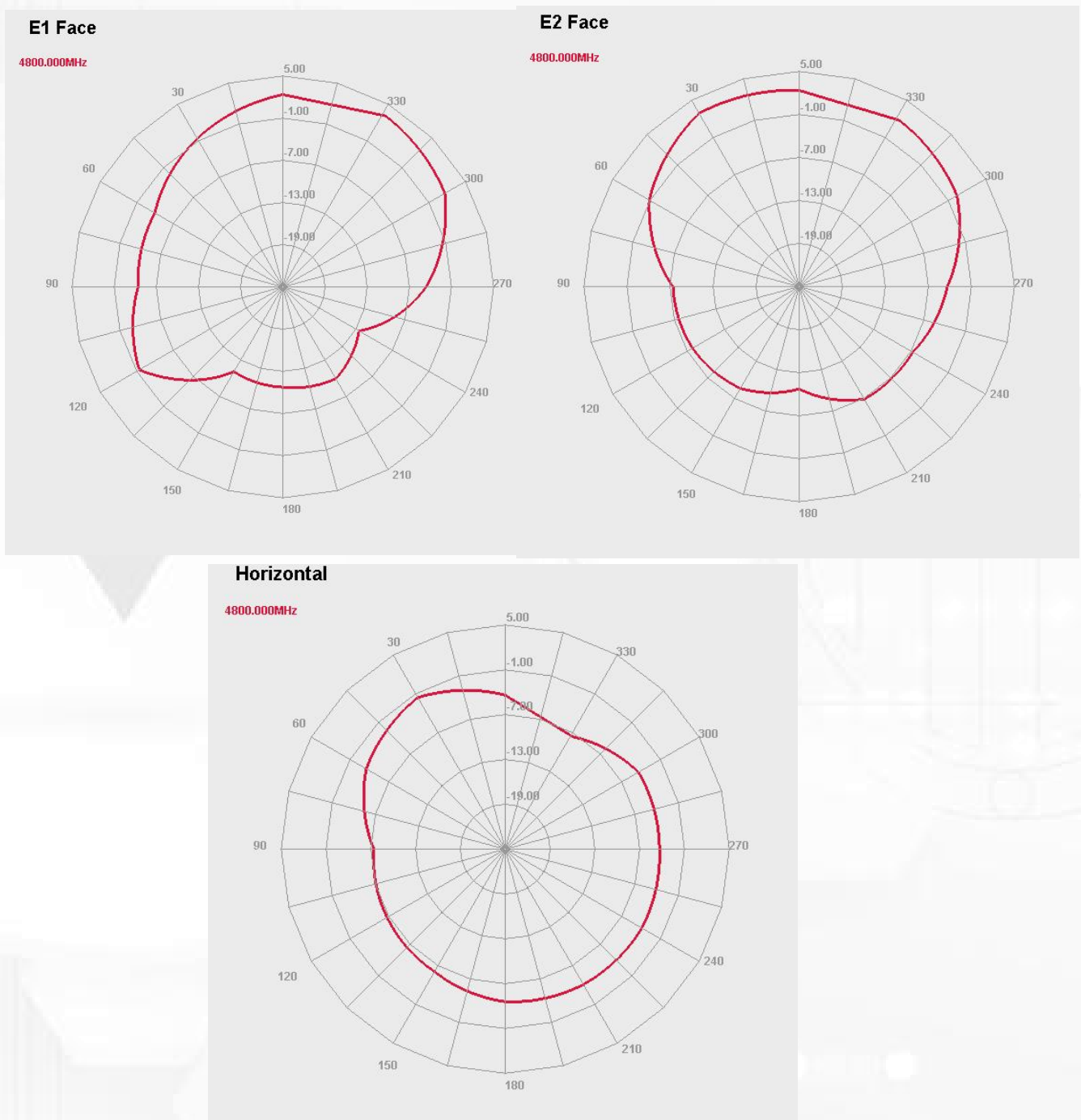

Maswell Cellular Antenna 5G 4G WiFi6 Screw
And 3M Adhesive Mount UV Stabilized IP67

AN_GSM_401

5800Mhz

E1 Face

5800.000MHz

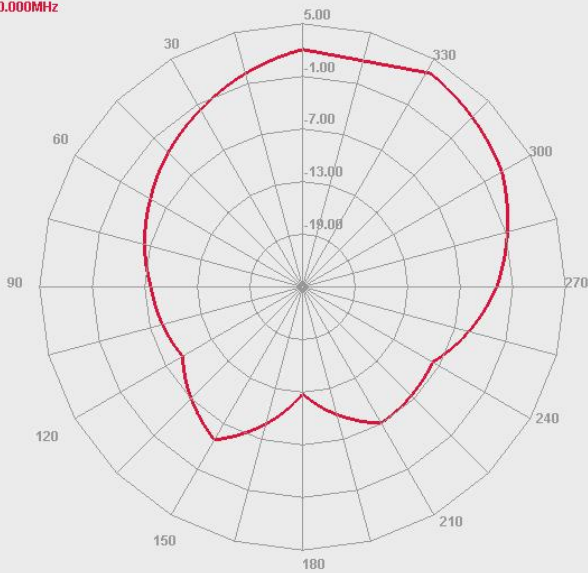

E2 Face

5800.000MHz



Horizontal

5800.000MHz

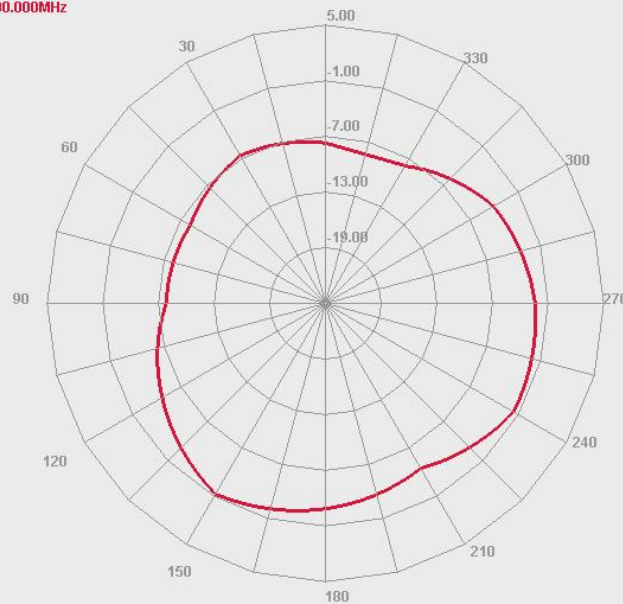

Maswell Cellular Antenna 5G 4G WiFi6 Screw
And 3M Adhesive Mount UV Stabilized IP67

AN_GSM_401

600.00MHz - 6000.00MHz Gain

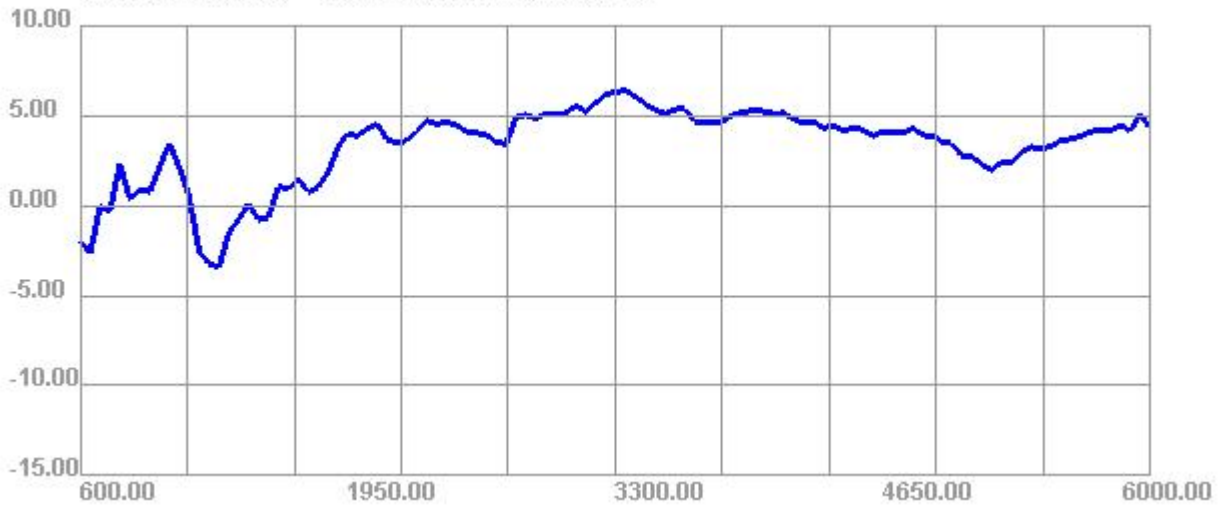

NEW
TECHNOLOGY

600.00MHz - 6000.00MHz Efficiency

