

Datasheet

2.4-2.5GHz & 5.15-7.2GHz

External / Indoor

Features:

High performing Wi-Fi 6/6E antenna with RP-SMA connector for indoor applications.

Applications:

- CPE – Router, Set-top boxes, Gateway
- IoT devices
- Wi-Fi 6E Mesh
- Smart Metering
- Robotics



Stick Antenna



Electrical Specifications

Antenna Characteristics

Antenna Type	Radiation Pattern	Polarization	Max. Input Power	Impedance
Stick Antenna	Omni	Linear	1W	50Ω

Frequency (GHz)	2.4~2.5	5.15~5.825	5.925~7.125
Return Loss (dB)	< -10	< -10	< -10
Peak Gain (dBi)	2.7	4.6	4.4
Average Gain (dB)	-1.4	-1.8	-2.0
Efficiency (%)	73	66	63

Mechanical Specifications

Mechanical

Dimension (mm)	133.5
Connector Type	RP-SMA (Plug)
Material	PC+PPT
Weight (g)	12.0

Environmental

Temperature Range (°C)	-40 to 80
Humidity	Non-condensing 65°C 95% RH

RoHS Compliant

Mechanical Drawing

Unit : mm

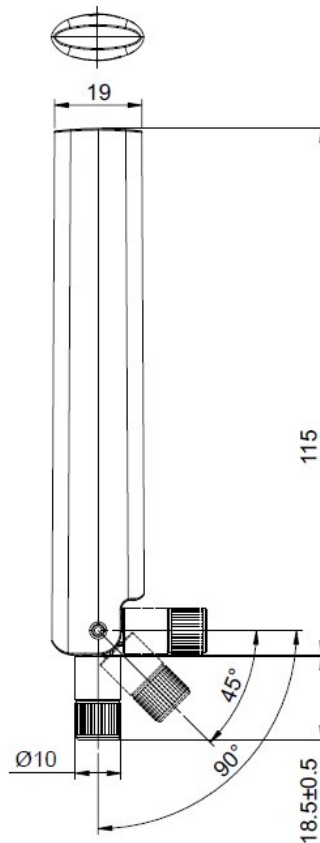

ST1228-30-502-A

Charts In Free Space

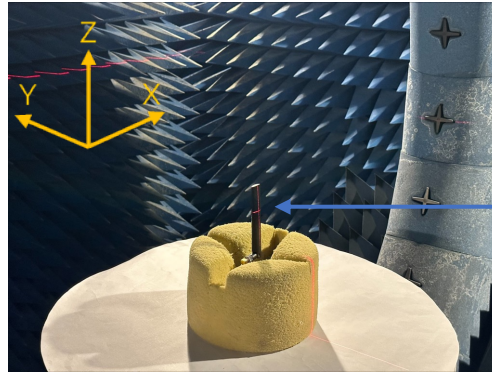

ST1228-30-502-A

Test setup, measurement performed in 3D anechoic chamber.

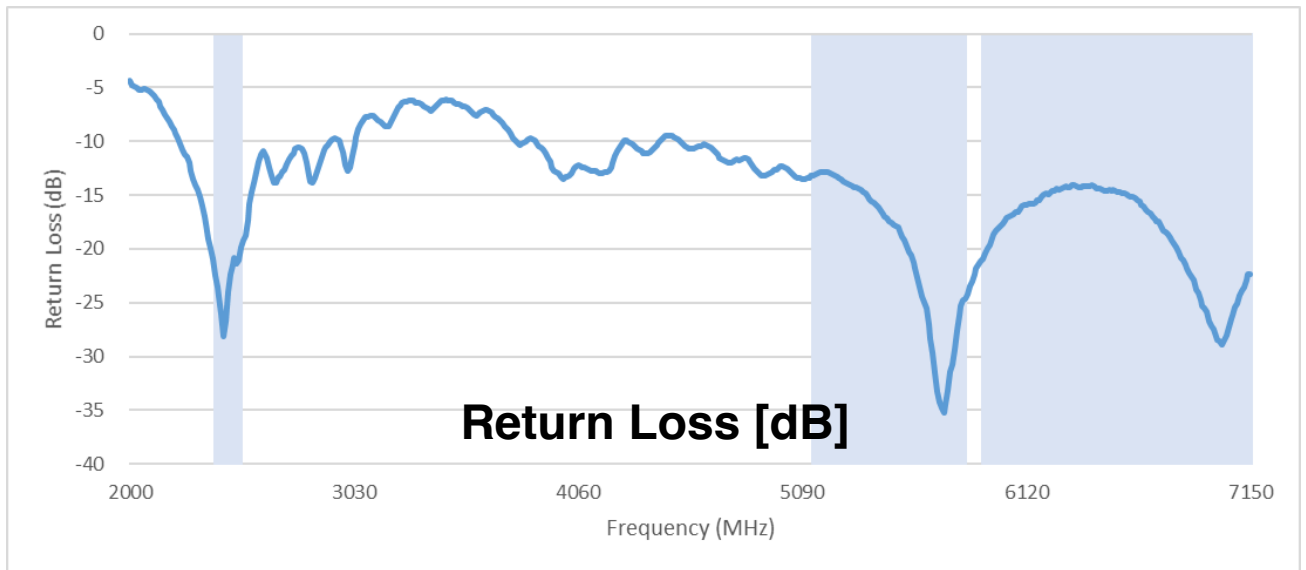

Blue background represents frequency response.

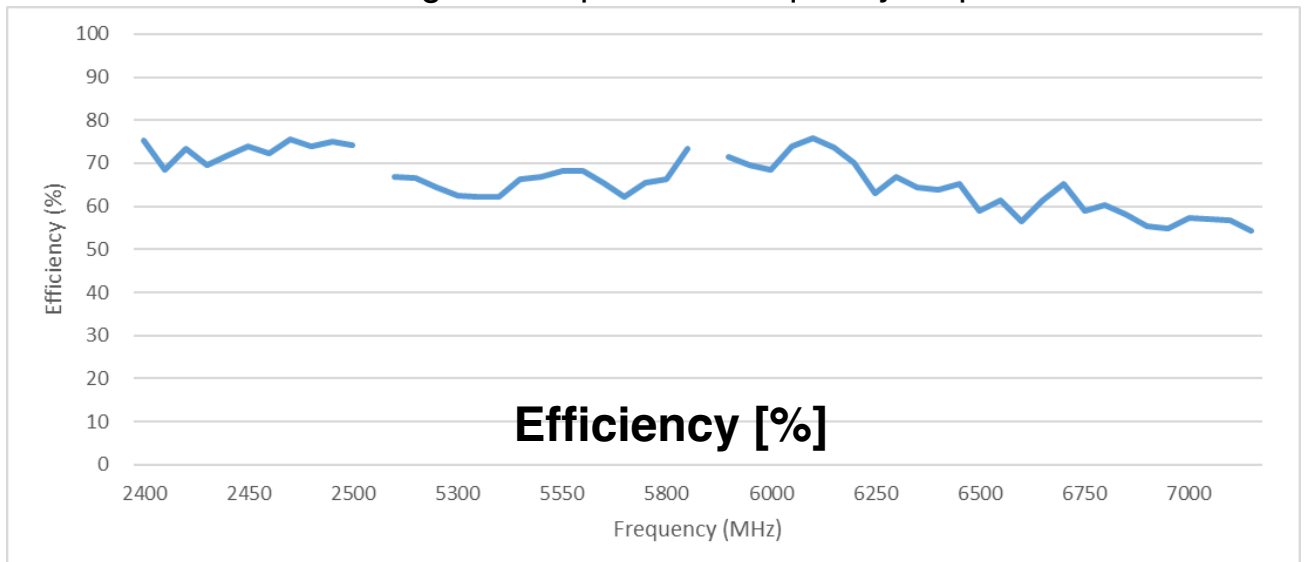

Radiation Pattern - Free Space

XY - Plane

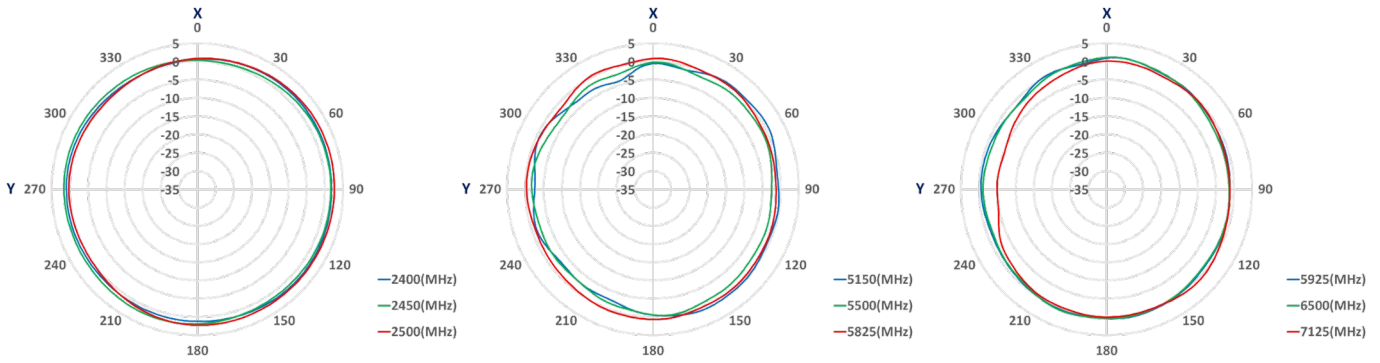

YZ - Plane

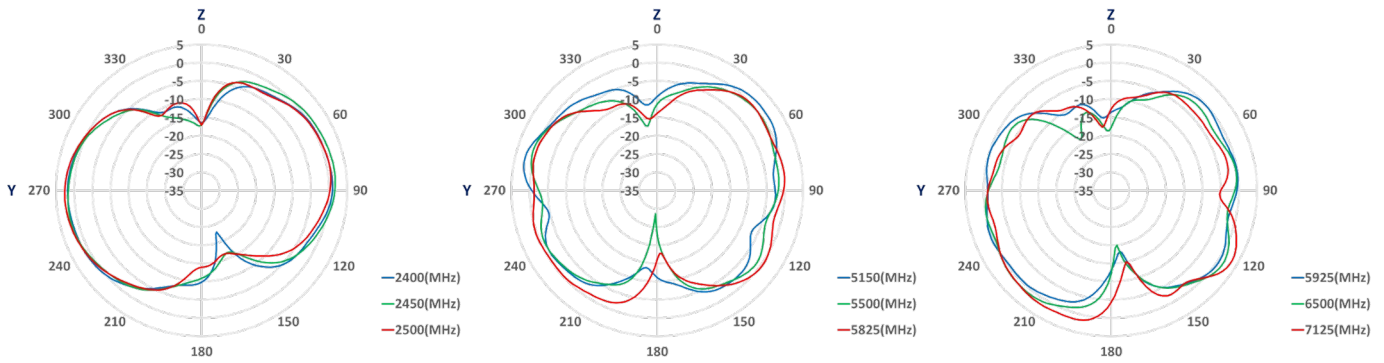

XZ - Plane

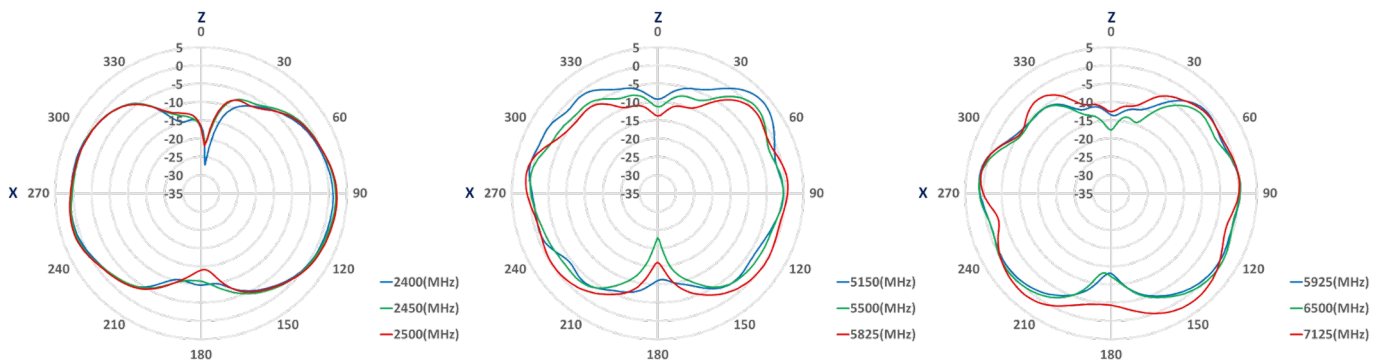

Revisions

Rev.	Description	Date	ECN	Approval
A	Initial Release	2023-02-20	ST1228-30-502-A-RA00	ATC

NOTICE - These drawings, specifications, or other data (1) are, and remain the property of Amphenol corp. (2) must be returned upon request; and (3) are confidential and not to be disclosed to any person other than those to whom they are given by Amphenol Corp. the furnishing of these drawings, specifications, or other data by Amphenol Corp., or to any other person to anyone for any purpose is not to be regarded by implication or otherwise in any manner licensing, granting rights to permitting such holder or any other person to manufacture, use or sell any product, process or design, patented or otherwise, that may in any way be related to or disclosed by said drawings, specifications, or other data.