

# THICK FILM CHIP RESISTOR ARRAYS

## - CN SERIES -

### FEATURES

- High density, more than 1 resistors in one small case
- Improvement of placement efficiency
- Tape/Reel packaging is suitable for automatic placement machine
- Superior solderability

### APPLICATIONS

- Master board
- CD & DVD Rom
- Hard Disk
- RAM

### CONSTRUCTION

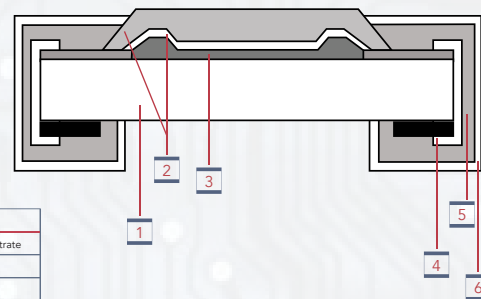

NO.	NAME
1	High Purity Alumina Substrate
2	Protective Covering
3	Resistive Covering
4	Termination Inner Ag/Pd
5	Termination Between Ni Plating
6	Termination Outer Sn Plating

### DERATIVE CURVE

- Resistors shall have a power rating based on continuous load operation at an ambient temperature of 70°C . For temperature in excess of 70°C
- The load shall be derate as shown. VV

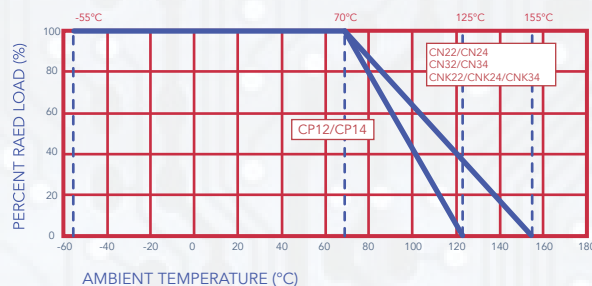

### PART NUMBER GUIDE

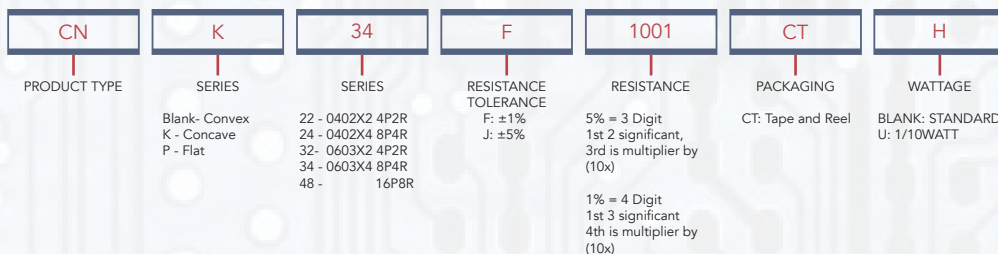

### RATINGS

TYPE	POWER RATING	MAX WORKING VOLTAGE	MAX OVERLOAD VOLTAGE	DIELECTRIC WITHSTANDING VOLTAGE	RESISTANCE RANGE ±5%, ±1%	TEMPERATURE COEFFICIENT PPM/°C	OPERATING TEMPERATURE	RESISTANCE VALUE OF JUMPER	RATED CURRENT OF JUMPER
CN22	1/16W	50V	100V	100V	10Ω~1MΩ	±200	-55°C~+155°C	<50MΩ	1A
CN24	1/16W	50V	100V	100V	10Ω~1MΩ	±200			
CN32	1/16W	50V	100V	100V	10Ω~1MΩ	±200			
CN34	1/16W	50V	100V	300V	10Ω~1MΩ	≥10Ω±200 <10Ω±400			
CN34----CTH	1/10W	50V	100V	300V	10Ω~1MΩ	≥10Ω±200 <10Ω±400			
CN48	1/16W	50V	100V	300V	10Ω~1MΩ	≥10Ω±200 <10Ω±400			
CNK22	1/16W	50V	100V	100V	10Ω~1MΩ	±200			
CNK24	1/16W	50V	100V	100V	10Ω~1MΩ	±200			
CNK34	1/10W	50V	100V	300V	10Ω~1MΩ	≥10Ω±200 <10Ω±400	-55°C~+125°C	<50MΩ	1A
CNK12	1/20W	12.5V	25V	/	10Ω~1MΩ	±200			
CNK14	1/20W	12.5V	25V	/	10Ω~1MΩ	±200			

**DIMENSIONS IN MM**

CN22 | CN32

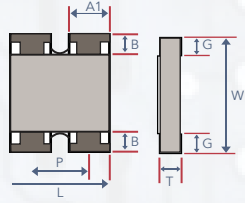

CN24 | CN34

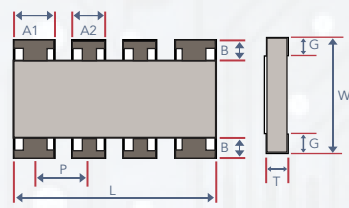

CN48

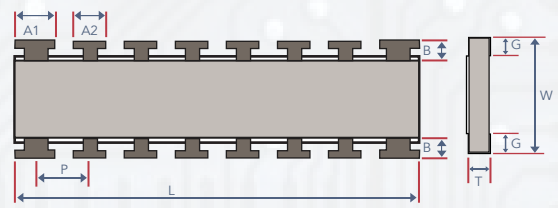

CNK22

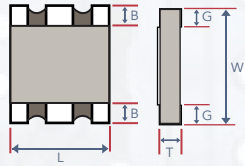

CNK24/CNK34

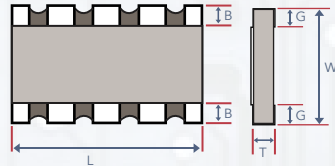

CNP12

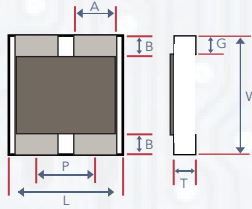

CNP14

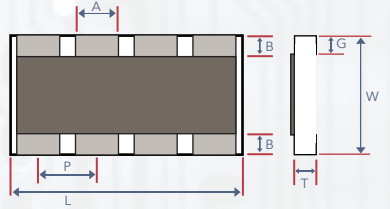

UNIT=mm

TYPE	L	W	T	A1	A2	B	P	G
CN22 0402*2	1.00±0.10	1.00±0.10	0.35±0.10	0.33±0.10	/	0.15±0.05	0.65±0.05	0.25±0.10
CN24 0402*4	2.00±0.10	1.00±0.10	0.45±0.10	0.40±0.05	0.30±0.05	0.20±0.15	0.50±0.05	0.30±0.15
CN32 0603*2	1.60±0.15	1.60±0.15	0.50±0.10	0.60±0.15	/	0.30±0.10	0.80±0.05	0.25±0.10
CN34 0603*4	3.20±0.20	1.60±0.20	0.50±0.10	0.65±0.15	0.50±0.15	0.30±0.15	0.80±0.10	0.30±0.15
CN48	4.00±0.20	1.60±0.15	0.45±0.10	0.45±0.05	0.30±0.05	0.30±0.15	0.50±0.05	0.40±0.15
CNK22 0402*2	1.00±0.10	1.00±0.10	0.35±0.10	/	/	0.15±0.10	/	0.30±0.10
CNK24 0402*4	2.00±0.10	1.00±0.10	0.45±0.10	/	/	0.15±0.10	/	0.30±0.10
CNK34 0603*4	3.20±0.20	1.60±0.20	0.60±0.10	/	/	0.30±0.20	/	0.40±0.10
CNP12 0201*2	0.80±0.10	0.60±0.10	0.35±0.10	0.30±0.10	/	0.15±0.10	0.50±0.05	0.15±0.10
CNP14 0201*4	1.40±0.10	0.60±0.10	0.35±0.10	0.20±0.10	/	0.15±0.10	0.40±0.05	0.15±0.10

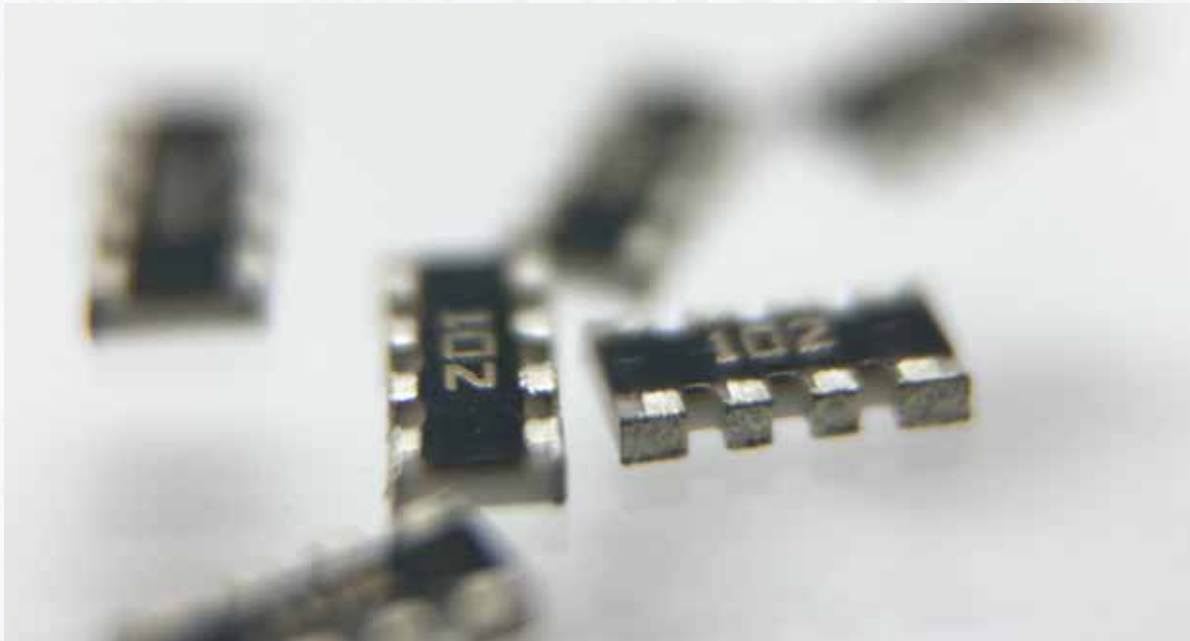

## MARKINGS

- Normal for CN22 & CNK22 & CNK24 size, no marking on the body, 0Ω resistors is no marking too.

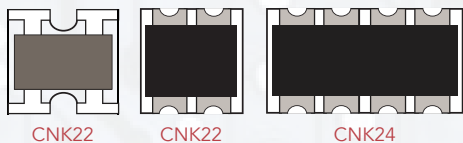

-±1% Tolerance of CN32, CN24, CN34, CNK34, and CN48 size: first three digits are significant figures of resistance and the fourth denotes number of zeros following

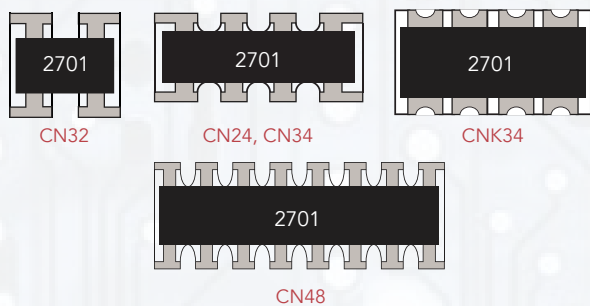

- Normal for CNP12 and CNP14 sizes, no marking on the body. 0Ω resistors is no marking too



-±5% Tolerance of CN24, CN32, CN34, CNK34 and CN48 size: the first two digits are significant figures of resistance and the third denotes number of zeros following

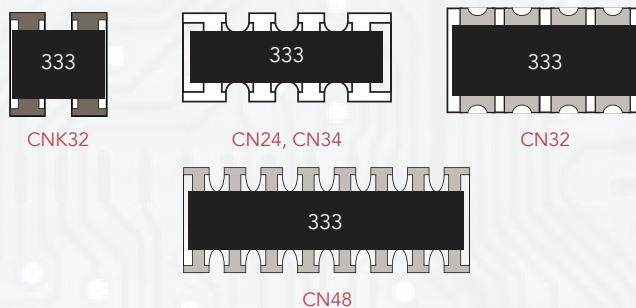

- Normal of CN32, CN24, CN34, CNK34 and CN48 size, the marking as following:

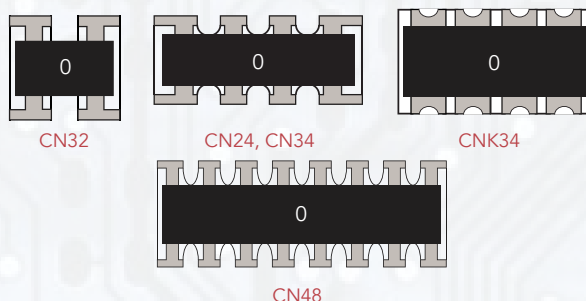

## SOLDERING PAD SIZE RECOMMENDED

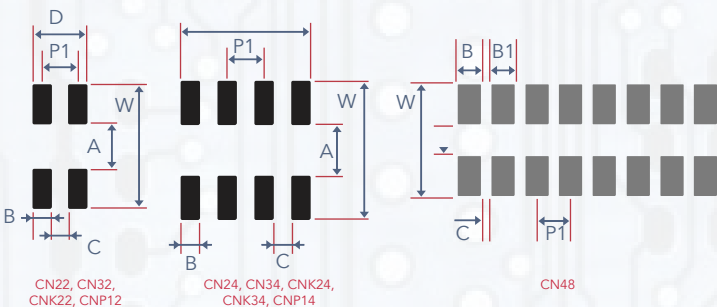

## EQUIVALENT CIRCUIT DIAGRAM

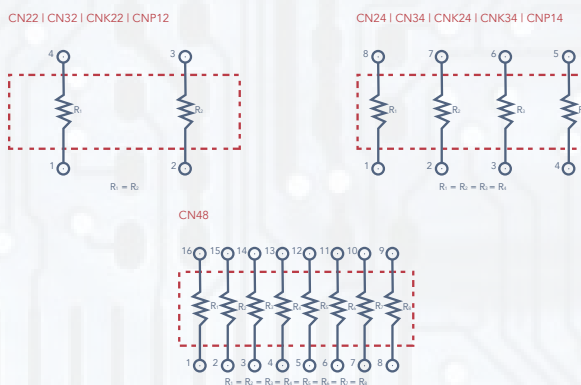

TYPE	DIMENSION (MM)							
	A	B	B1	B2	W	C	P1	D
CN22	0.5 ± 0.1	0.33 ± 0.1	/	/	2.0 ± 0.1	0.34 ± 0.1	/	1.0 ± 0.1
CN24	0.5 ± 0.1	0.3 ± 0.1	0.28 ± 0.1	0.28 ± 0.1	2.0 ± 0.1	0.22 ± 0.1	/	1.82 ± 0.1
CN32	0.8 ± 0.1	0.45 ± 0.05	/	/	2.6 ± 0.2	0.35 ± 0.05	0.80 ± 0.05	/
CN34	1.0 ± 0.1	0.4 ± 0.1	0.4 ± 0.1	0.4 ± 0.1	2.6 ± 0.1	0.40 ± 0.1	/	2.8 ± 0.1
CN48	1.0 ± 0.1	0.3 ± 0.1	0.3 ± 0.1	/	2.3 ± 0.1	0.20 ± 0.1	0.50 ± 0.1	/
CNK22	0.5 ± 0.1	0.3 ± 0.1	/	/	2.0 ± 0.1	0.20 ± 0.1	/	0.8 ± 0.1
CNK24	0.5 ± 0.1	0.3 ± 0.1	0.3 ± 0.1	0.3 ± 0.1	2.0 ± 0.1	0.20 ± 0.1	/	1.8 ± 0.1
CNK34	1.0 ± 0.1	0.4 ± 0.1	0.4 ± 0.1	0.4 ± 0.1	2.6 ± 0.1	0.40 ± 0.1	/	2.8 ± 0.1
CNK12	0.3 ± 0.1	0.3 ± 0.05	/	/	0.9 ± 0.2	0.20 ± 0.05	0.50 ± 0.05	/
CNK14	0.3 ± 0.1	0.2 ± 0.05	/	/	0.9 ± 0.2	0.20 ± 0.05	0.45 ± 0.05	/

## SOLDERING CONDITION

(this is for recommendation, please customer perform adjustment according to actual application)

- Recommend Reflow Soldering Profile (solder : Sn96.5 / Ag3 / Cu0.5)

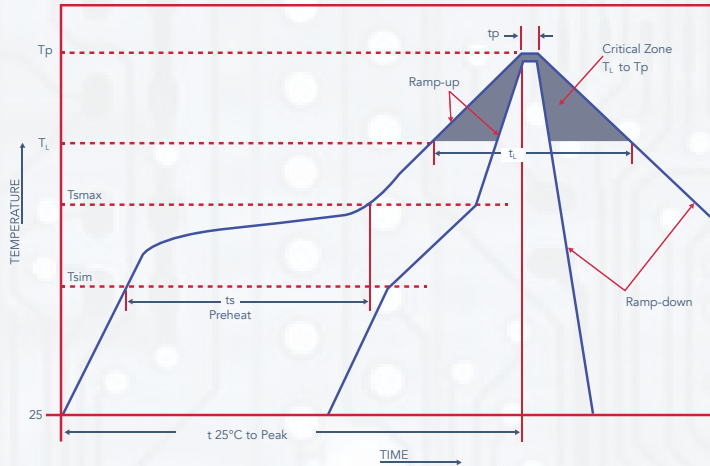

PROFILE FEATURE	LEAD (Pb) - FREE SOLDER
Preheat: Temperature Min ( $T_{s_{min}}$ ) Temperature Max ( $T_{s_{max}}$ ) Time ( $T_{s_{min}}$ to $T_{s_{max}}$ ) (ts)	150°C 200°C 60-120 seconds
Average ramp-up rate: ( $T_s$ max $T_p$ )	3°C / second max.
Time maintain above: Temperature ( $T_l$ ) Time ( $t_l$ )	217°C 60-150 seconds
Peak Temperature ( $T_p$ )	260°C
Time Within +0-5°C Of Actual Peak Temperature ( $T_p$ ) <sup>2</sup>	10 seconds
Ramp-down Rate	6°C/second max.
Time 25°C to Peak Temperature	8 minutes max.

Allowed Re-flow times: 2 times  
Remark: To avoid discoloration phenomena of chip on terminal electrodes, please use N2 Re-flow furnace.

## RECOMEND WAVE SOLDERING

(Apply to 0603 and above size)

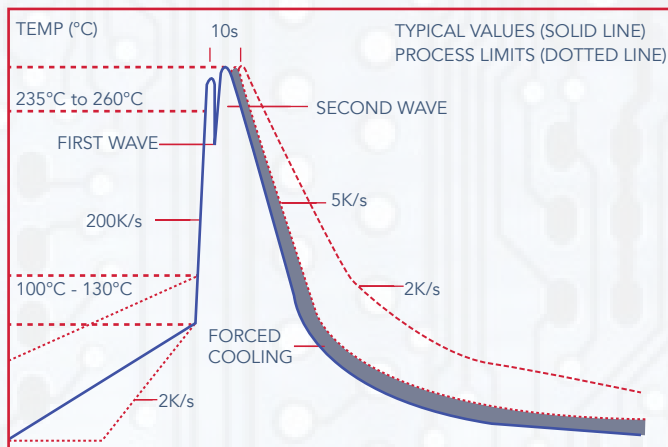

## PERFORMANCE SPECIFICATION

ITEM	SPECIFICATIONS
Short Time Overload	±(2.0%±0.1Ω) CNP12: 1%: ±(1%+0.05Ω) 5%: (2%+0.05Ω)
Insulation Resistance	≥1000MΩ
Dielectric Withstanding Voltage	No evidence of flashover mechanical damage, arcing or insulation break down.
Terminal Bending	±(1%+0.05Ω)
Soldering Heat	ΔR/R ≤ ±(1.0%+0.05Ω)
Solderability	Coverage must be over 95%
Rapid Change of Temperature	ΔR/R ≤ ±(1.0%+0.05Ω) CNP12: 1%: ±(0.5%+0.05Ω) 5%: ±(1%+0.05Ω)
Load Life in Humidity	CNP12: 1%: ±(2%+0.1Ω) 5%: ±(3.0%+0.1Ω)
Load Life	CNP12: 1%: ±(2%+0.1Ω) 5%: ±(3.0%+0.1Ω)

## LABELS

CCE P/N CN34J000CT

Cust PN

QTY 5000<sub>ea</sub>

Lot Code 2065112

Date Code 2132

32<sup>nd</sup> week of 2021



# PACKAGING

## REEL SPECIFICATIONS & PACKAGING QUANTITY

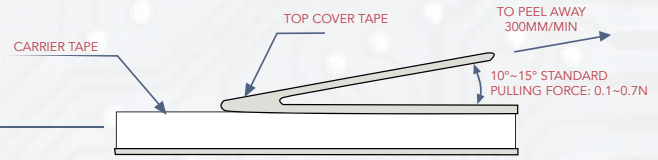
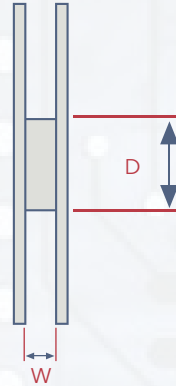
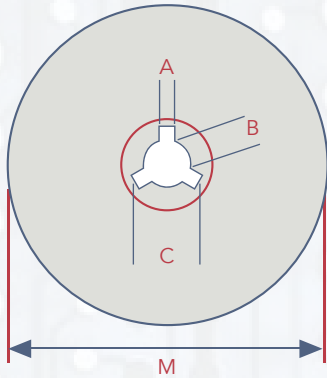

TYPE	QUANTITY /REEL	A ± 0.5	B ± 0.5	C ± 0.05	D ± 1	M ± 2	W ± 1
CN22	10,000 pcs.	2.0	13.0	21.0	60.0	178.0	10.0
CN24	10,000 pcs.	2.0	13.0	21.0	60.0	178.0	10.0
CN32	5,000 pcs.	2.0	13.0	21.0	60.0	178.0	10.0
CN34	5,000 pcs.	2.0	13.0	21.0	60.0	178.0	10.0
CN48	4,000 pcs.	2.0	13.0	21.0	60.0	178.0	13.8
CNK22	10,000 pcs.	2.0	13.0	21.0	60.0	178.0	10.0
CNK24	10,000 pcs.	2.0	13.0	21.0	60.0	178.0	10.0
CNK34	5,000 pcs.	2.0	13.0	21.0	60.0	178.0	10.0
CNP12	15,000 pcs.	2.0	13.0	21.0	60.0	178.0	10.0
CNP14	15,000 pcs.	2.0	13.0	21.0	60.0	178.0	10.0

### - Dimension of Paper Taping : (mm)

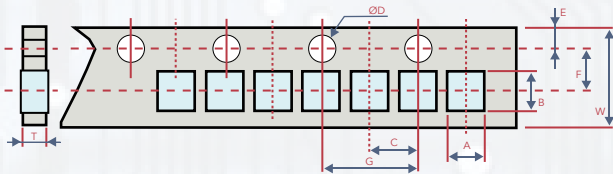

TYPE	A±0.2	B±0.2	C±0.05	ØD+0.1 -0	E±0.1	F±0.05	G±0.1	W±0.2	T±0.1
CN22/CNK22	1.20	1.20	2.0	1.5	1.75	3.50	4.00	8.0	0.45
CN24/CNK24	1.20	2.20	2.0	1.5	1.75	3.50	4.00	8.0	0.70
CNP12	0.79	1.00	2.0	1.5	1.75	3.50	4.00	8.0	0.50
CNP14	0.90	1.70	2.0	1.5	1.75	3.50	4.00	8.0	0.50

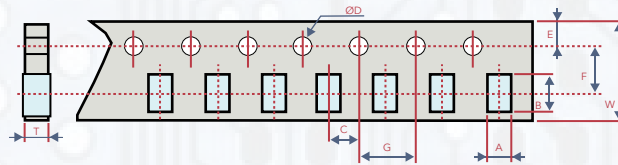

TYPE	A±0.2	B±0.2	C±0.05	ØD+0.1 -0	E±0.1	F±0.05	G±0.1	W±0.2	T±0.1
CN34/CNK34	2.00	3.60	2.0	1.5	1.75	3.50	4.00	8.0	0.83
CN32	1.90	1.90	2.0	1.5	1.75	3.50	4.00	8.0	0.83

### - Dimension of Embossed Taping : (mm)

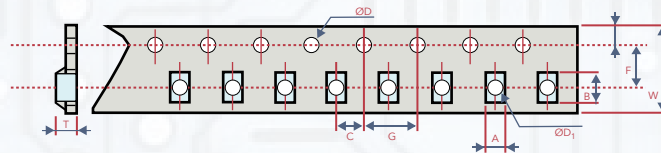

TYPE	A±0.2	B±0.2	C±0.05	ØD+0.1 -0	ØD+0.25 -0	E±0.1	F±0.05	G±0.1	W±0.2	T±0.1
CN48	1.80	4.30	2.00	1.50	1.00	1.75	5.50	4.00	12.0	0.75