

BOOM-M

~30° medium beam. Assembly with 0.2 mm thick installation tape.

SPECIFICATION:

Dimensions	Ø 22.2 mm
Height	14.3 mm
Fastening	tape
ROHS compliant	yes ⓘ



MATERIALS:

Component	Type	Material	Colour	Finish	Length
BOOM-M	Reflector	PC	metal		22.2
BOOM-TAPE	Tape	PET tape	clear		16.0

ORDERING INFORMATION:

Component		Qty in box	MOQ	MPQ	Box weight (kg)
CA10930_BOOM-M	Reflector	1680	336	112	5.4
» Box size: 480 x 280 x 300 mm					

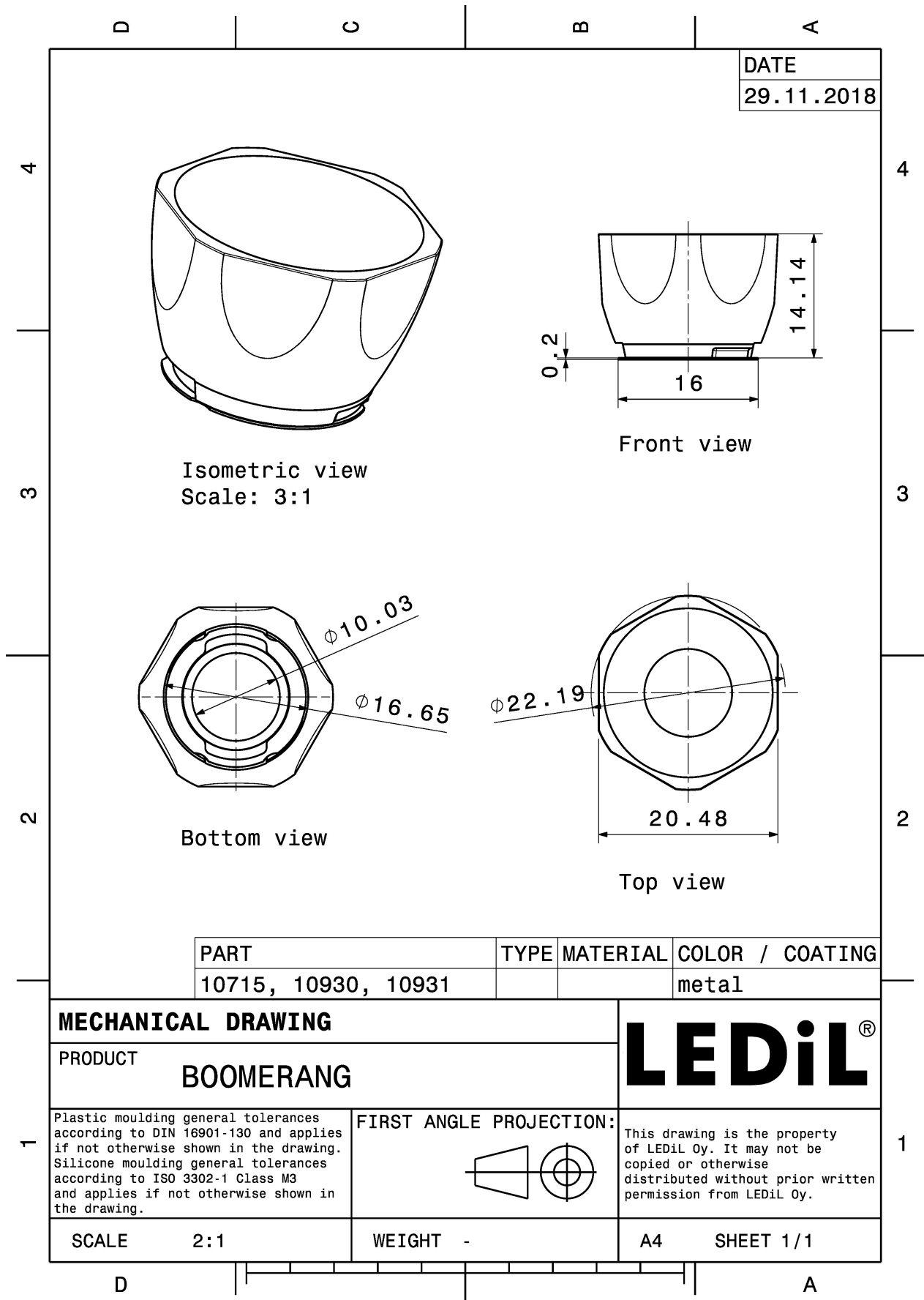

DATE
29.11.2018

Isometric view
Scale: 3:1

Front view

Bottom view

Top view

PART	TYPE	MATERIAL	COLOR / COATING
10715, 10930, 10931			metal

MECHANICAL DRAWING		LEDiL®
PRODUCT BOOMERANG		
Plastic moulding general tolerances according to DIN 16901-130 and applies if not otherwise shown in the drawing. Silicone moulding general tolerances according to ISO 3302-1 Class M3 and applies if not otherwise shown in the drawing.	FIRST ANGLE PROJECTION: 	This drawing is the property of LEDiL Oy. It may not be copied or otherwise distributed without prior written permission from LEDiL Oy.
SCALE 2:1	WEIGHT -	

See also our general installation guide: www.ledil.com/installation_guide

OPTICAL RESULTS (MEASURED):



LED MHB-A/B
FWHM / FWTM 31.0° / 70.0°
Efficiency 82 %
Peak intensity 2.2 cd/lm
LEDs/each optic 1
Light colour/type White
Required components:

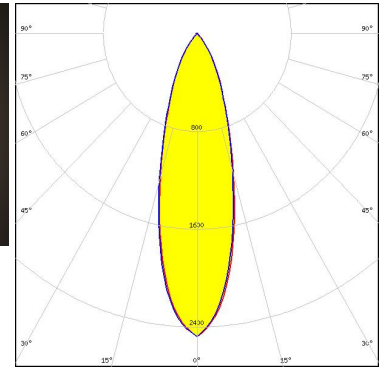
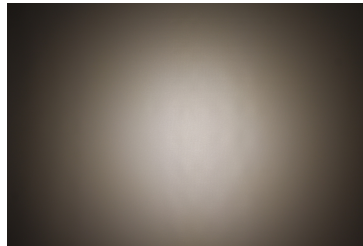

Light distribution files



LED MHD-E/G
FWHM / FWTM 34.0° / 72.0°
Efficiency 82 %
Peak intensity 1.7 cd/lm
LEDs/each optic 1
Light colour/type White
Required components:

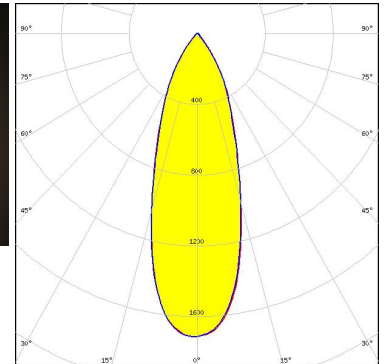
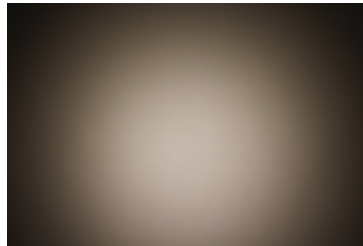

Light distribution files



LED LUXEON M/MX
FWHM / FWTM 30.0° / 66.0°
Efficiency 79 %
Peak intensity 2.2 cd/lm
LEDs/each optic 1
Light colour/type White
Required components:

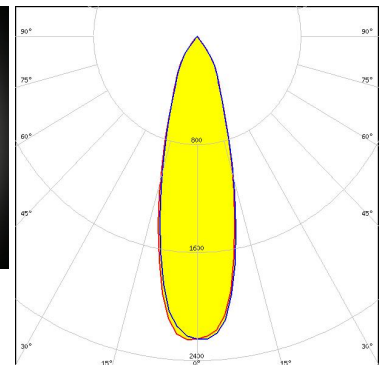
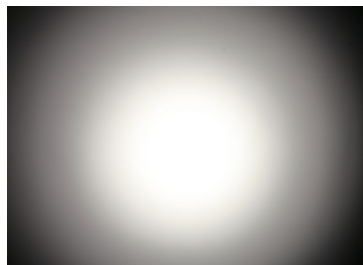

Light distribution files

OPTICAL RESULTS (MEASURED):



LED LUXEON MZ
FWHM / FWTM 20.0° / 41.0°
Efficiency 75 %
Peak intensity 4 cd/lm
LEDs/each optic 1
Light colour/type White
Required components:

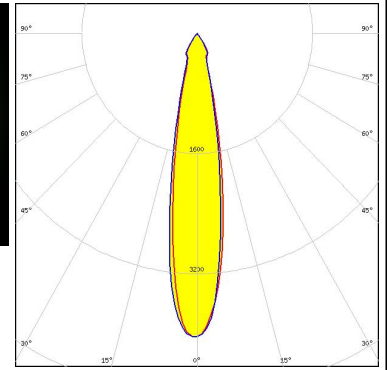

Light distribution files



LED NFMW48xA
FWHM / FWTM 23.0° / 59.0°
Efficiency 80 %
Peak intensity 3.1 cd/lm
LEDs/each optic 1
Light colour/type White
Required components:

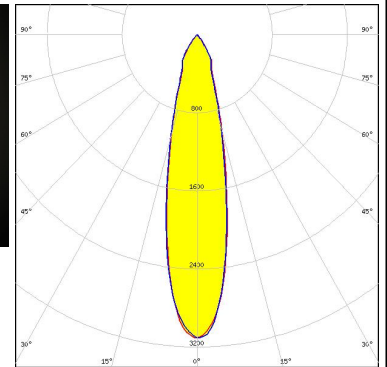

Light distribution files



LED Duris S10
FWHM / FWTM 28.0° / 65.0°
Efficiency 74 %
Peak intensity 2.5 cd/lm
LEDs/each optic 1
Light colour/type White
Required components:

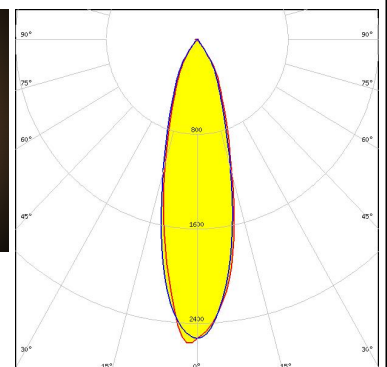
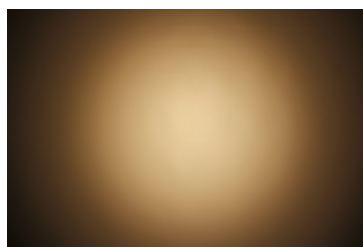

Light distribution files

OPTICAL RESULTS (MEASURED):

 SEOL SEMICONDUCTOR	
LED	P7
FWHM / FWTM	33.0° / 74.0°
Efficiency	%
Peak intensity	1.9 cd/m
LEDs/each optic	1
Light colour/type	White
Required components:	
Light distribution files	

OPTICAL RESULTS (SIMULATED):



LED MC-E
FWHM / FWTM 23.0° / 60.0°
Efficiency 90 %
Peak intensity 3.4 cd/lm
LEDs/each optic 1
Light colour/type White
Required components:

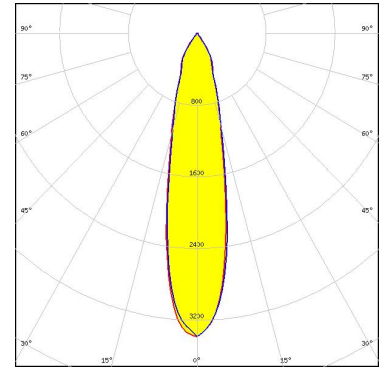

Light distribution files



LED LUXEON 5050 Round LES
FWHM / FWTM 22.0° / 52.0°
Efficiency 86 %
Peak intensity 3.7 cd/lm
LEDs/each optic 1
Light colour/type White
Required components:

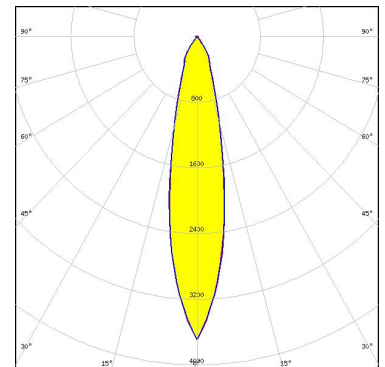

Light distribution files



LED LUXEON 7070
FWHM / FWTM 31.0° / 67.0°
Efficiency 83 %
Peak intensity 2.2 cd/lm
LEDs/each optic 1
Light colour/type White
Required components:

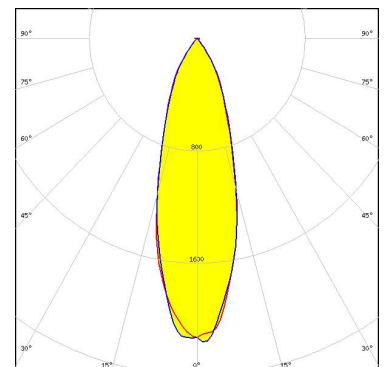

Light distribution files

OPTICAL RESULTS (SIMULATED):



LED COB S-Type (LES 7)
FWHM / FWTM 31.6° / 67.0°
Efficiency 82 %
Peak intensity 2.1 cd/lm
LEDs/each optic 1
Light colour/type White
Required components:

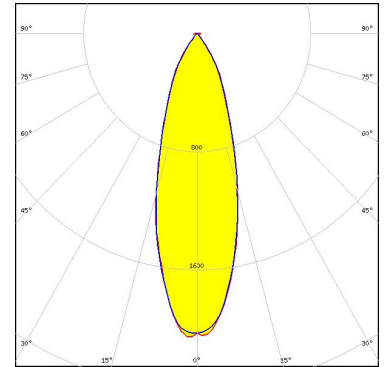

Light distribution files



LED Duris S8
FWHM / FWTM 25.7° / 61.7°
Efficiency 87 %
Peak intensity 2.9 cd/lm
LEDs/each optic 1
Light colour/type White
Required components:

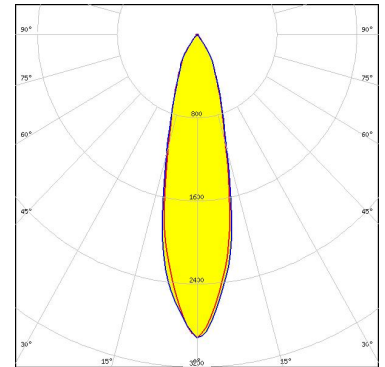

Light distribution files



LED OSCONIQ P 7070
FWHM / FWTM 25.0° / 63.0°
Efficiency 85 %
Peak intensity 3.3 cd/lm
LEDs/each optic 1
Light colour/type White
Required components:

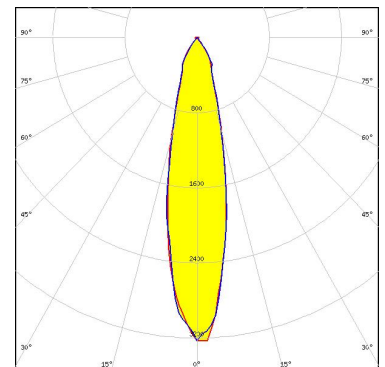

Light distribution files

OPTICAL RESULTS (SIMULATED):

 SEUL SEMICONDUCTOR	
LED	Z8Y19
FWHM / FWTM	22.0° / 50.0°
Efficiency	79 %
Peak intensity	3.3 cd/lm
LEDs/each optic	4
Light colour/type	White
Required components:	

Light distribution files

GENERAL INFORMATION:

NOTE: The typical beam angle will be changed by different color, chip size and chip position tolerance. The typical total beam angle is the full angle measured where the luminous intensity is half of the peak value.

Due to use of high power COB's with this product, special attention to proper thermal design is highly recommended. LEDiL has no liability for direct, indirect or consecutive damages arising from the LEDiL products being used outside of the recommended temperature range.

MATERIALS:

As part of our continuous research and improvement processes, and to ensure the best possible quality and availability of our products, LEDiL reserves the right to change material grades without notice.

PRODUCT DATA USER AGREEMENT AND DISCLAIMER:

The measured data in the provided downloadable LEDiL Product Datasheets and Mechanical 2D-Drawings is rounded and provided as reference for planning. LEDiL Oy's optical specifications have been verified by conducting performance testing of the products in accordance with the company's quality system. The reported data are averaged results of multiple measurements with typical variation. LEDiL Oy reserves the right to without prior notification make changes and improvements to its products.

LEDiL Oy assumes neither warranty, nor guarantee nor any other liability of any kind for the contents and correctness of the provided data. The provided data has been generated with highest diligence but the provided data may in reality not represent the complete possible variation range of all intrinsic parameters. Therefore, in certain cases a deviation from the provided data could occur.

LEDiL Oy reserves the right to undertake technical changes of its products without further notification which could lead to changes in the provided data. LEDiL Oy assumes no liability of any kind for the possible deviation from any provided data or any other damage resulting from the usage of the provided data.

The user agrees to this disclaimer and user agreement with the download or usage of the provided files.

LEDiL Oy

Joensuunkatu 13
FI-24240 SALO
Finland

LEDiL Inc.

228 West Page Street
Suite D
Sycamore IL 60178
USA

Ledil Optics Technology (Shenzhen) Co., Ltd.

405 , Block B
Casic Motor Building
Shenzhen 518057
P.R.CHINA

Local sales and technical support

[www.ledil.com/
where_to_buy](http://www.ledil.com/where_to_buy)

Shipping locations

Poznan, Poland
Hong Kong, China

Distribution Partners

[www.ledil.com/
where_to_buy](http://www.ledil.com/where_to_buy)