

Long Distance Reflective Switch

OPB720A and OPB720B Series



Features:

- 0.04" to 12" (1 mm to 305 mm) with 90% reflective material. (Typical Maximum detection distance to be set at factory)
- Recognizes objects as small as 0.08" (2 mm)
- Ambient light rejection < 100K Lux
- Open collector output
- Cable length 39" (990 mm) lead length 28 AWG wire

Description:

The **OPB720A and OPB720B** Series reflective switches detects objects as far away as 12" (305 mm) using standard 90% reflective material, and can detect objects as small as 0.08" (2 mm). The OPB720 series consist of three standard reflective switching distances -**06Z** for typically 6" (152 mm), -**12Z** for typically 12" (305 mm) and -**30VZ** for typically 30" (762 mm). The power supply voltage range of the **OPB720A** series is 10 to 30 volts while the power supply voltage range for the **OPB720B** is 4 to 7 volts.

The **OPB720A and OPB720B** sensors are **NOT** affected by ambient light in most conditions. Ambient light conditions are compensated by using a synchronous driver detection scheme.

This sensor has a logical output that switches from a high level with reflective target to a low level with no reflective target. With the addition of hysteresis, the **OPB720** series minimizes output switching oscillations. The type of material used for the target is very dependent on the distance that can be achieved for the sensor. Taking this into consideration, the **OPB720** series can be used in either a reflective or interruptive mode. As an example, the **OPB720A-12Z** can easily be used in a reflective mode for distances around 12" (305 mm) while when reflecting off a retro-reflective target similar to 3M 3870 or Nippon Crystallite at distances around 85" (216 mm) the device works well in the interruptive mode. See the included charts for typical distances with different reflective material for other versions of the **OPB720** series devices.

The **OPB720** series has an open collector output transistor and power requirements are compatible with most PLCs and TTL gates.

Applications:

- Conveyer belt package recognition
- Personnel movement recognition
- Near-focus security systems
- Hand wash and soap dispensing stations
- Toilet and urinal sensors
- Product dispensing systems

Ordering Information	
Part Number	Description
OPB720A-06Z OPB720B-06Z	Maximum detection of 0.04" to 6" (1.0 mm to 152 mm) 39" (991 mm) lead length with 28 AWG wire, using white 90% reflective paper
OPB720A-12Z OPB720B-12Z	Maximum detection of 0.04" to 12" (1.0 mm to 305 mm) 39" (991 mm) lead length with 28 AWG wire, using white 90% reflective paper
OPB720A-30VZ Obsolete OPB720B-30VZ	Maximum detection of 0.04" to 30" (1.0 mm to 762 mm) 39" (991 mm) lead length with 28 AWG wire, using white 90% reflective paper

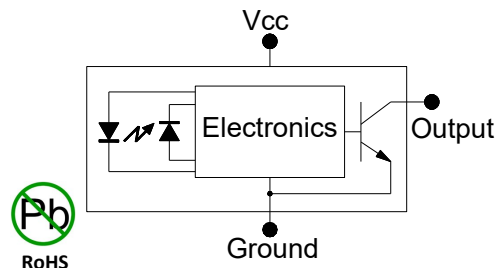

OPB720B-30VZ ONLY

Additional laser safety information can be found on the Otek website. See application #221. Classification is not marked on the device due to space limitations. See package outline for centerline of optical radiance. Operating devices beyond maximum rating may cause devices to exceed rated classification.

General Note
TT Electronics reserves the right to make changes in product specification without notice or liability. All information is subject to TT Electronics' own data and is considered accurate at time of going to print.

TT Electronics | OPTEK Technology
2900 E. Plano Pkwy, Plano, TX 75074 | Ph: +1 972 323 2200
www.ttelectronics.com | sensors@ttelectronics.com

Long Distance Reflective Switch

OPB720A and OPB720B Series



Pin #	Description
Red	V _{CC}
White	Output
Black	Ground

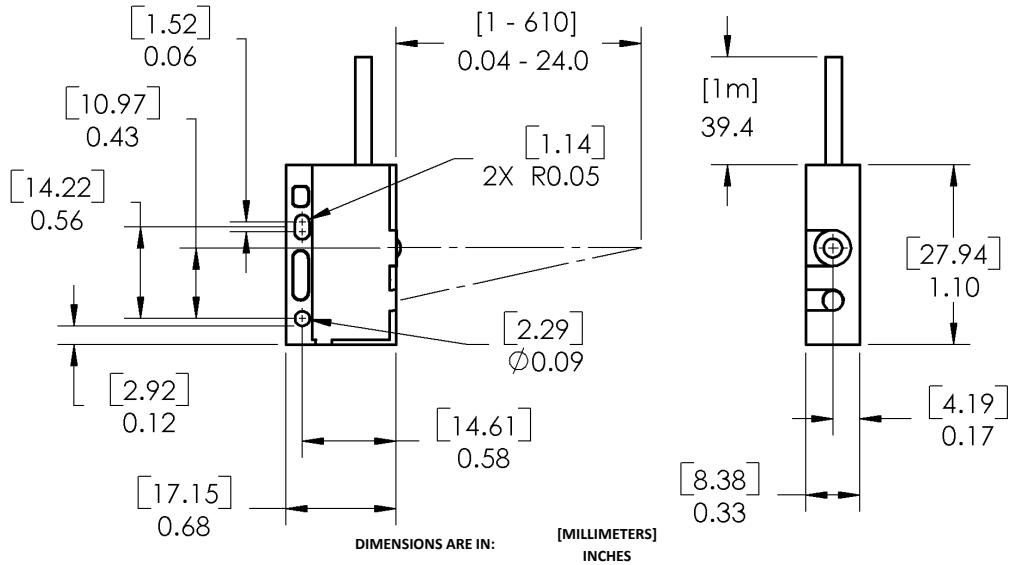

Absolute Maximum Ratings (T_A = 25° C unless otherwise noted)

Operating Temperature Range OPB720A Series OPB720B Series	0° C to +50° C 0° C to +70° C
Storage Temperature Range	-40° C to +80° C
Lead Soldering Temperature (1/16" (1.6 mm) from case for 5 seconds with soldering iron)	260° C ⁽¹⁾
Supply Voltage (V _{CC}) OPB720A Series OPB720B Series	10 to 30 Volts 4 to 7 Volts
Maximum Collector Voltage	30 V
Collector DC Current (Sink)	50 mA
Power Dissipation	300 mW

Electrical Characteristics (T_A = 25° C unless otherwise noted)

SYMBOL	PARAMETER	MIN	TYP	MAX	UNITS	TEST CONDITIONS
V _{OL}	Low Level Output Voltage OPB720A Series OPB720B Series	-	-	0.8	V	V _{CC} = 10 Volts, Note 4 V _{CC} = 4 Volts, Note 4
V _{OH}	High Level Output Voltage OPB720A Series OPB720B Series	5.0 3.5	- -	- -	V	V _{CC} = 10 Volts, Note 5 V _{CC} = 4 Volts, Note 5

Notes:

- (1) RMA flux is recommended. Duration can be extended to 10 seconds maximum when flow soldering.
- (2) Distance for OPB720A-06Z = 6" (152 mm), Distance for OPB720A-12Z = 12" (305 mm).
- (3) OPB720B-30VZ are class 1M laser safety device. Do Not look at the device closer than 4" (100 mm) with a magnifying device.
- (4) R_L = 10 K, V_{CE} = V_{CC} Distance = See Note 2 & 3, (No Target).
- (5) R_L = 10 K, V_{CE} = V_{CC}, (90% Reflective Surface, Kodak—EK E152-7798)

General Note

TT Electronics reserves the right to make changes in product specification without notice or liability. All information is subject to TT Electronics' own data and is considered accurate at time of going to print.

TT Electronics | OPTeK Technology
2900 E. Plano Pkwy, Plano, TX 75074 | Ph: +1 972 323 2200
www.ttelectronics.com | sensors@ttelectronics.com

Long Distance Reflective Switch

OPB720A and OPB720B Series



Voltage Response vs Displacement
OPB720A-06Z or OPB720B-06Z

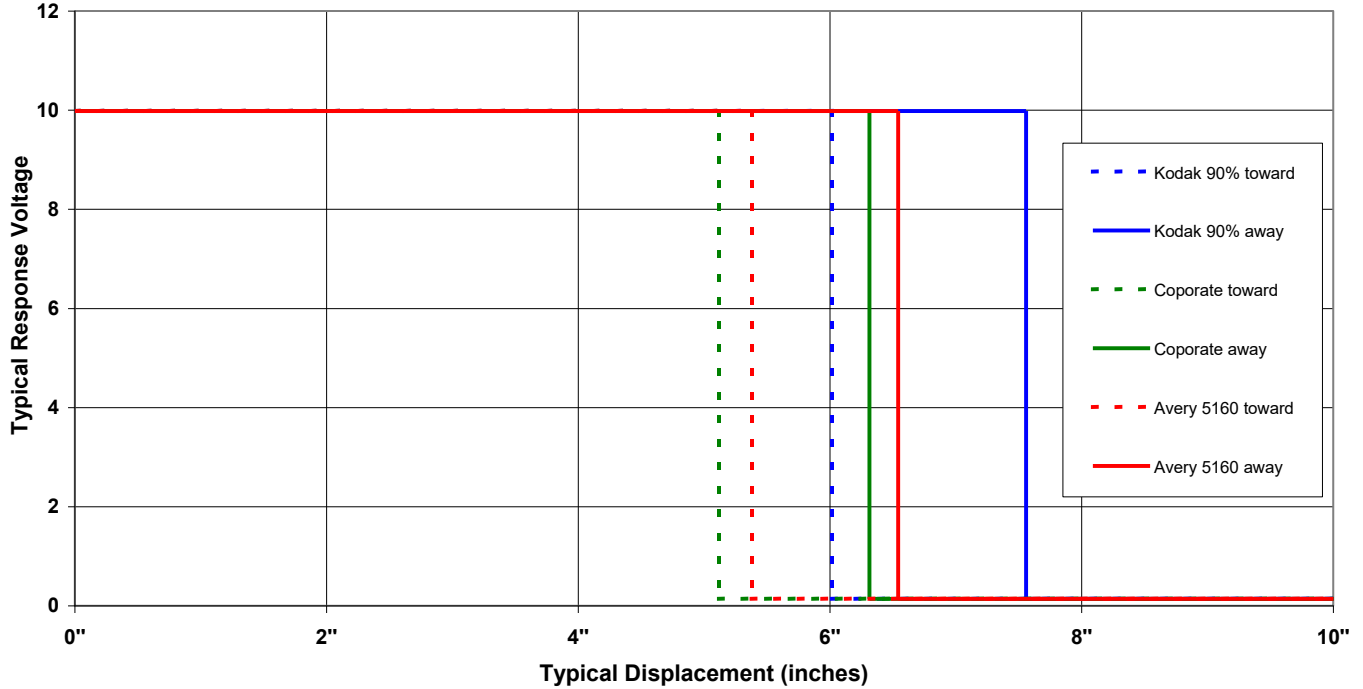

Voltage Response vs Displacement
OPB720A-06Z or OPB720B-06Z

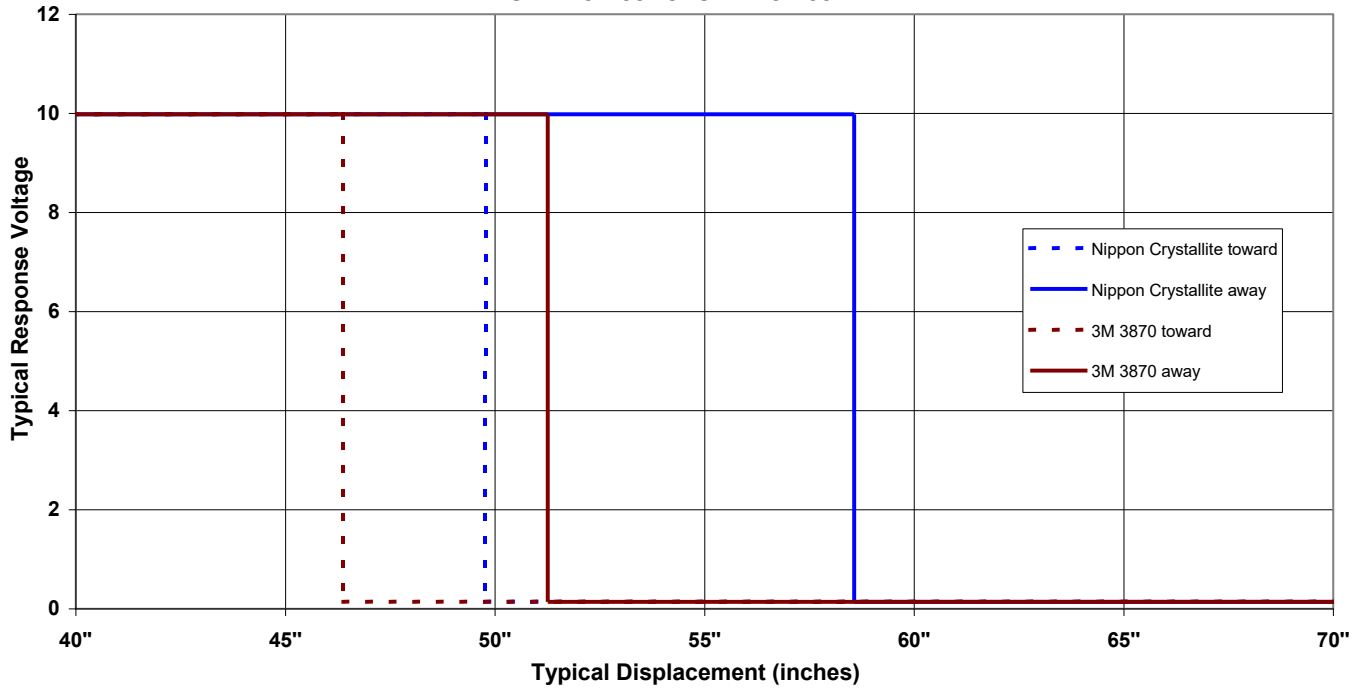

General Note

TT Electronics reserves the right to make changes in product specification without notice or liability. All information is subject to TT Electronics' own data and is considered accurate at time of going to print.

TT Electronics | OPTEK Technology
2900 E. Plano Pkwy, Plano, TX 75074 | Ph: +1 972 323 2200
www.ttelectronics.com | sensors@ttelectronics.com

Long Distance Reflective Switch

OPB720A and OPB720B Series



Voltage Response vs Displacement
OPB720A-12Z or OPB720B-12Z

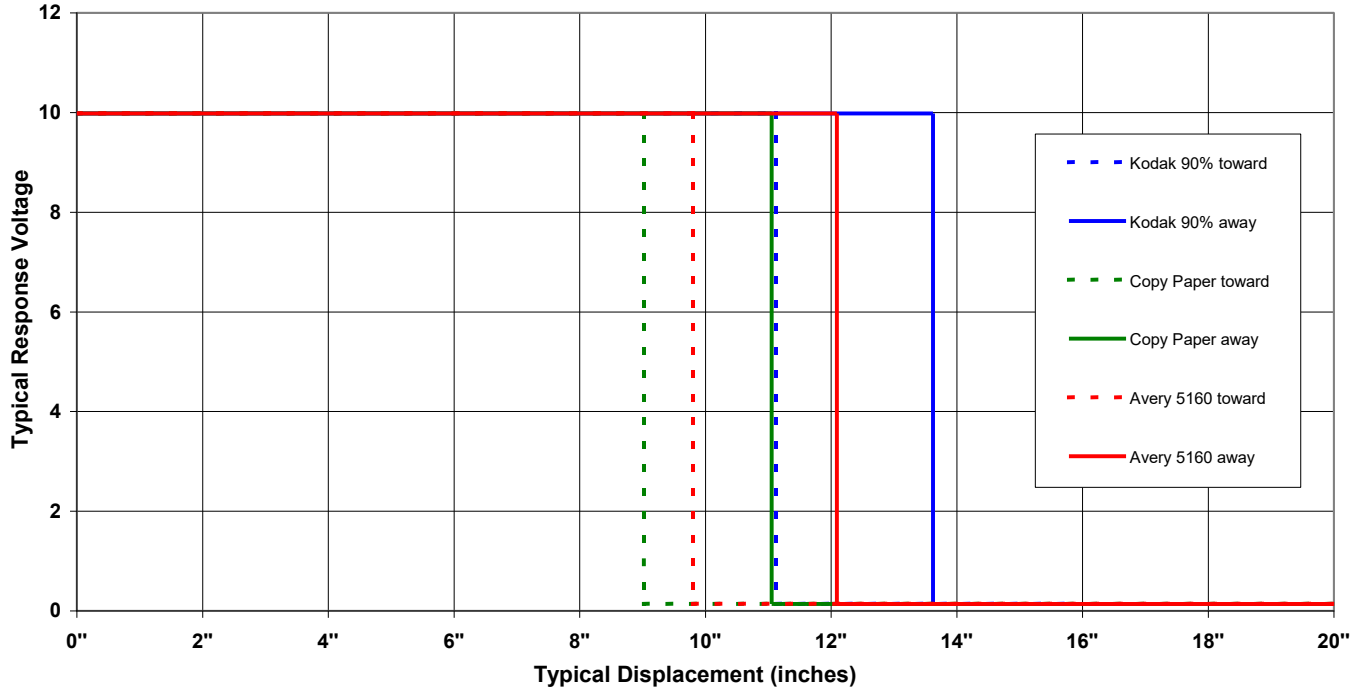

Voltage Response vs Displacement
OPB720A-12Z or OPB720B-12Z

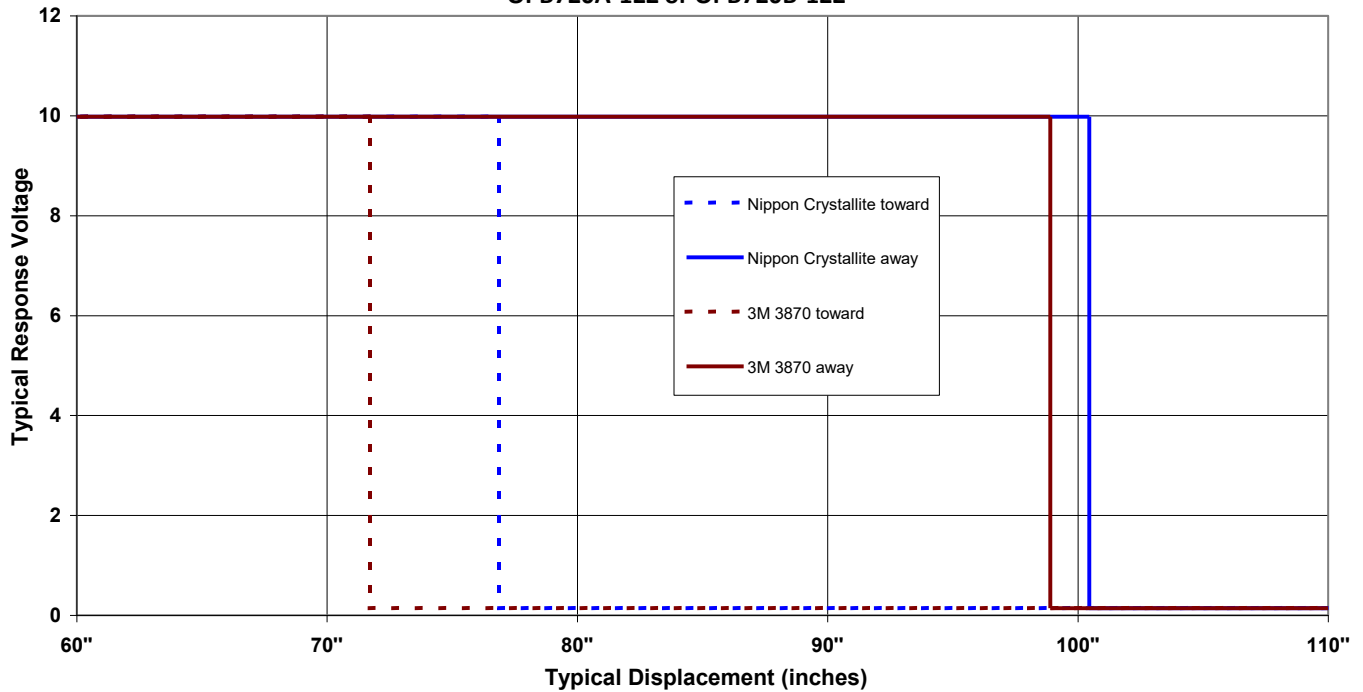

General Note

TT Electronics reserves the right to make changes in product specification without notice or liability. All information is subject to TT Electronics' own data and is considered accurate at time of going to print.

TT Electronics | OPTEK Technology
2900 E. Plano Pkwy, Plano, TX 75074 | Ph: +1 972 323 2200
www.ttelectronics.com | sensors@ttelectronics.com

Long Distance Reflective Switch

OPB720A and OPB720B Series



Voltage Response vs Displacement

OPB720B-30VZ

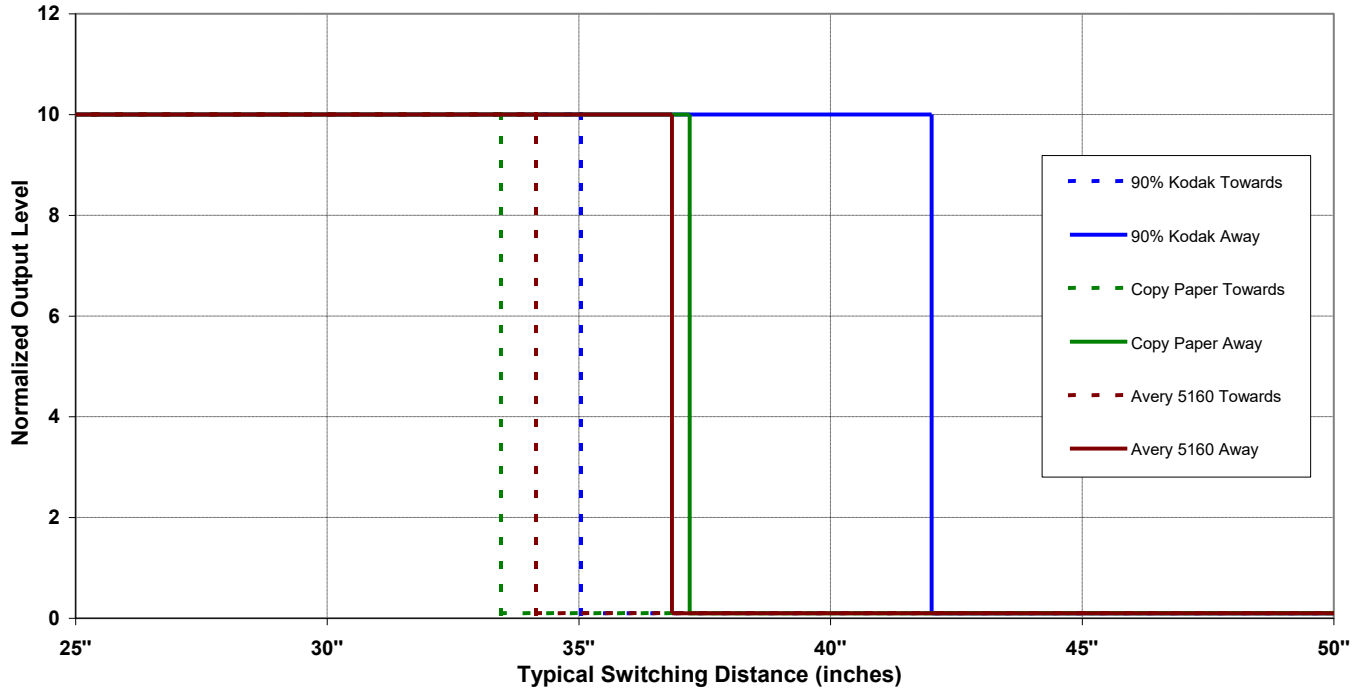

Voltage Response vs Displacement

OPB720B-30VZ

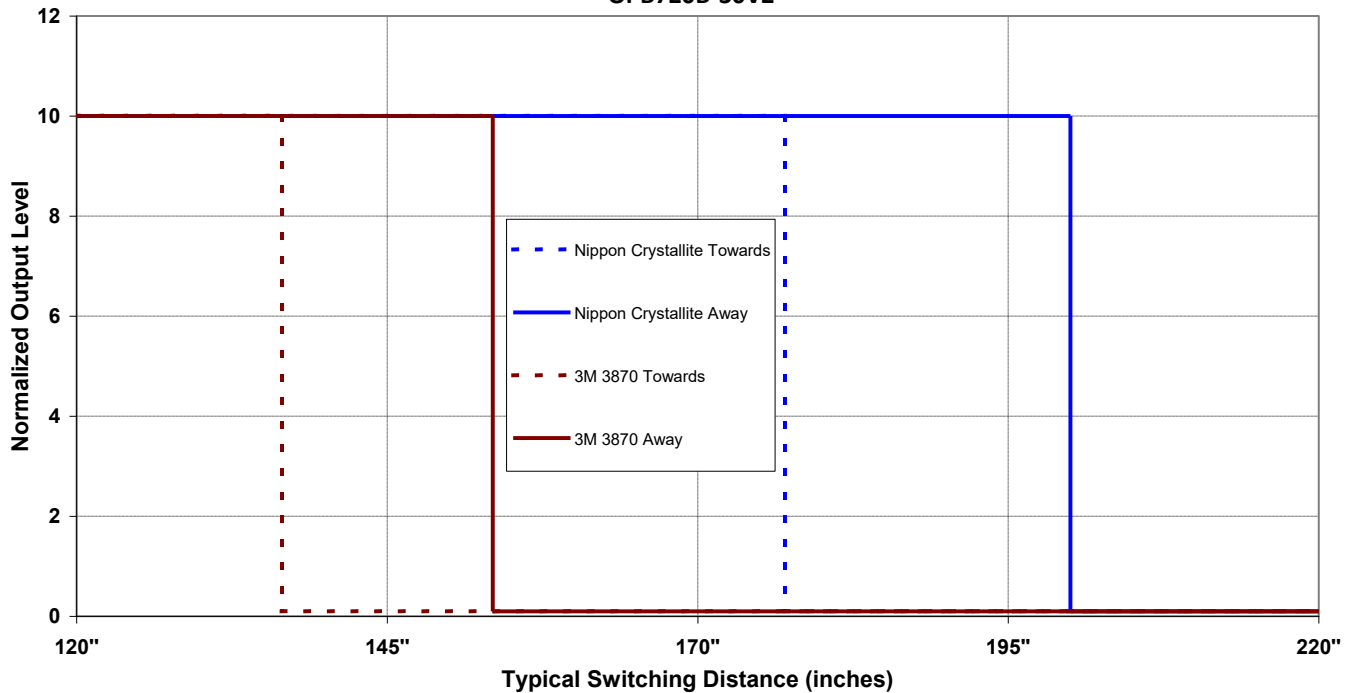

General Note

TT Electronics reserves the right to make changes in product specification without notice or liability. All information is subject to TT Electronics' own data and is considered accurate at time of going to print.

TT Electronics | OPTEK Technology
 2900 E. Plano Pkwy, Plano, TX 75074 | Ph: +1 972 323 2200
www.ttelectronics.com | sensors@ttelectronics.com