

925451-1 ✓ ACTIVE

MATE-N-LOK | Commercial MATE-N-LOK

TE Internal #: 925451-1

Rectangular Power Connectors, Housing, Plug, Wire-to-Wire, 18
Position, 5.2 mm / 6 mm [.236 in / .205 in] Centerline, Commercial
MATE-N-LOK

[View on TE.com >](#)



Connectors > Power Connectors > Rectangular Power > Rectangular Power Connectors

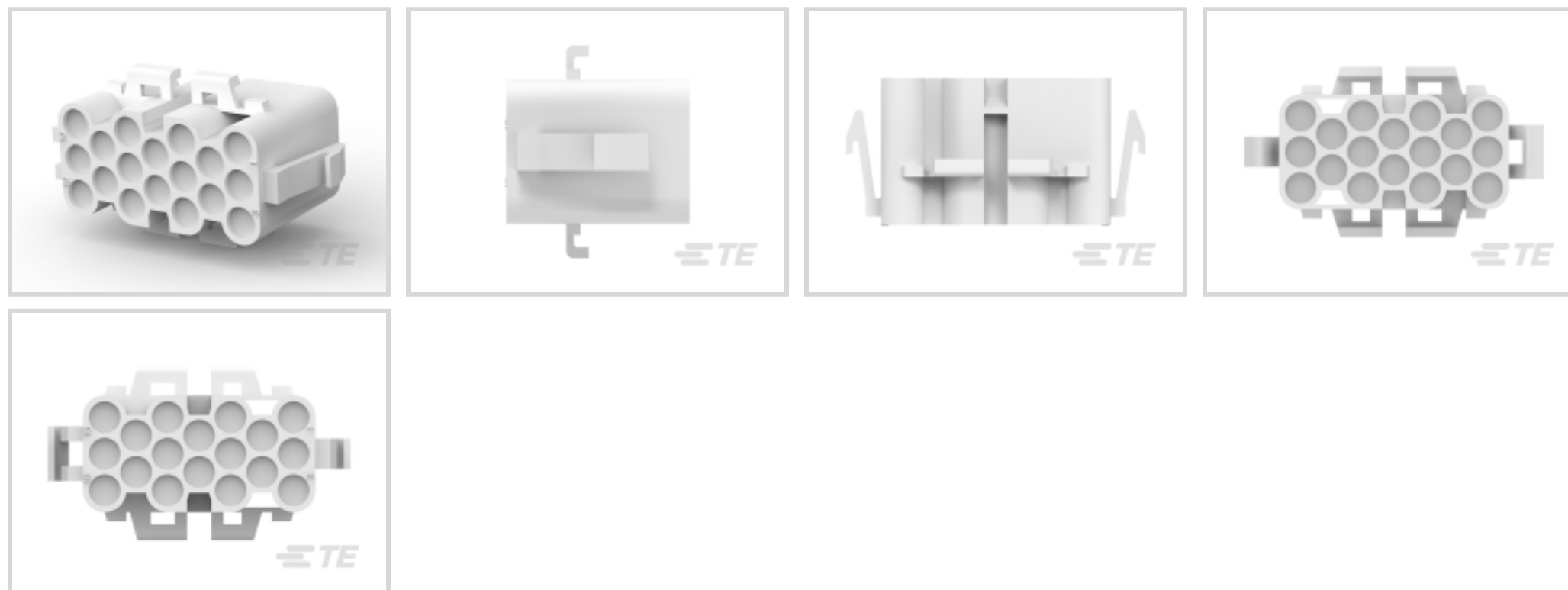

Rectangular Power Connector Type: **Housing**

Connector & Housing Type: **Plug**

Connector System: **Wire-to-Wire**

Number of Positions: **18**

Centerline (Pitch): **5.2 mm, 6 mm [.205 in, .236 in]**

Features

Product Type Features

Rectangular Power Connector Type	Housing
Connector & Housing Type	Plug
Connector System	Wire-to-Wire
Sealable	No
Connector & Contact Terminates To	Wire & Cable

Configuration Features

Number of Positions	18
Number of Rows	5

Electrical Characteristics

Operating Voltage	250 VAC
-------------------	---------

Contact Features

Contact Layout	Matrix
Contact Retention Within Housing	Without
Contact Type	Socket



Termination Features

Termination Method to Wire & Cable	Crimp
------------------------------------	-------

Mechanical Attachment

Connector Mounting Type	Cable Mount (Free-Hanging)
-------------------------	----------------------------

Housing Features

Centerline (Pitch)	5.2 mm, 6 mm [.205 in][.236 in]
--------------------	---------------------------------

Housing Color	Natural
---------------	---------

Housing Material	Polyamide 6.6
------------------	---------------

Dimensions

Connector Height	24.5 mm
------------------	---------

Row-to-Row Spacing	3 mm [.118 in]
--------------------	----------------

Usage Conditions

Operating Temperature Range	-55 - 105 °C [-67 - 221 °F]
-----------------------------	-----------------------------

Operation/Application

Circuit Application	Power & Signal
---------------------	----------------

Industry Standards

UL Flammability Rating	UL 94V-0
------------------------	----------

Glow Wire Rating	Standard Part - Not Glow Wire
------------------	-------------------------------

Packaging Features

Packaging Method	Bag
------------------	-----

Product Compliance

[For compliance documentation, visit the product page on TE.com>](#)

EU RoHS Directive 2011/65/EU	Compliant
------------------------------	-----------

EU ELV Directive 2000/53/EC	Compliant
-----------------------------	-----------

China RoHS 2 Directive MIIT Order No 32, 2016	No Restricted Materials Above Threshold
---	---

EU REACH Regulation (EC) No. 1907/2006	Current ECHA Candidate List: JAN 2024 (240) Candidate List Declared Against: JAN 2024 (240) Does not contain REACH SVHC
--	---

Halogen Content	Low Halogen - Br, Cl, F, I < 900 ppm per homogenous material. Also BFR/CFR/PVC
-----------------	--

Free

Solder Process Capability

Not applicable for solder process capability

Product Compliance Disclaimer

This information is provided based on reasonable inquiry of our suppliers and represents our current actual knowledge based on the information they provided. This information is subject to change. The part numbers that TE has identified as EU RoHS compliant have a maximum concentration of 0.1% by weight in homogenous materials for lead, hexavalent chromium, mercury, PBB, PBDE, DBP, BBP, DEHP, DIBP, and 0.01% for cadmium, or qualify for an exemption to these limits as defined in the Annexes of Directive 2011/65/EU (RoHS2). Finished electrical and electronic equipment products will be CE marked as required by Directive 2011/65/EU. Components may not be CE marked. Additionally, the part numbers that TE has identified as EU ELV compliant have a maximum concentration of 0.1% by weight in homogenous materials for lead, hexavalent chromium, and mercury, and 0.01% for cadmium, or qualify for an exemption to these limits as defined in the Annexes of Directive 2000/53/EC (ELV). Regarding the REACH Regulation, the information TE provides on SVHC in articles for this part number is based on the latest European Chemicals Agency (ECHA) 'Guidance on requirements for substances in articles' posted at this URL: <https://echa.europa.eu/guidance-documents/guidance-on-reach>

Compatible Parts

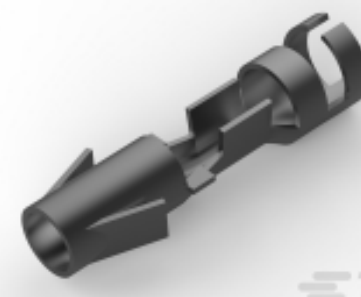
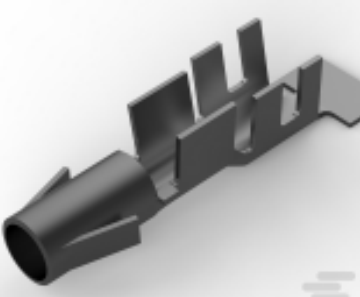
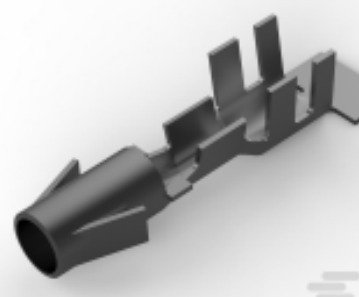
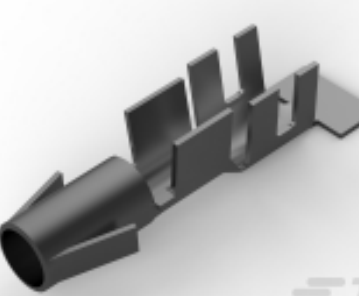
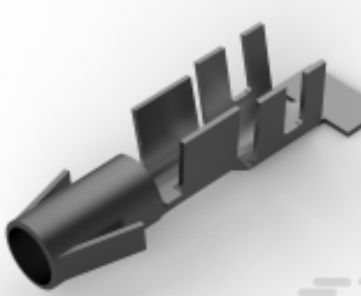
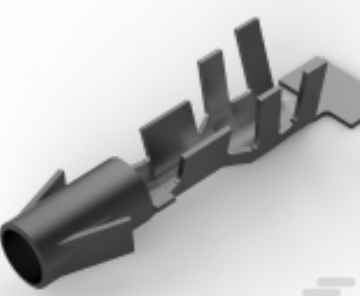
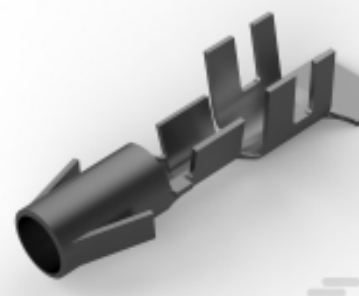
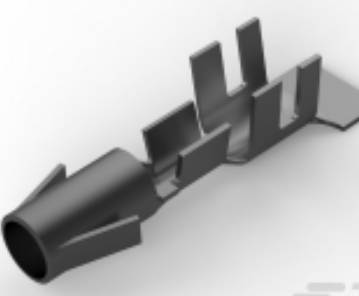
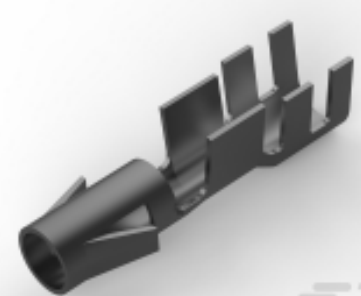
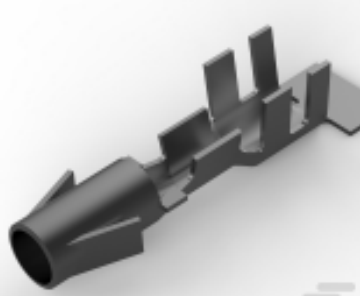
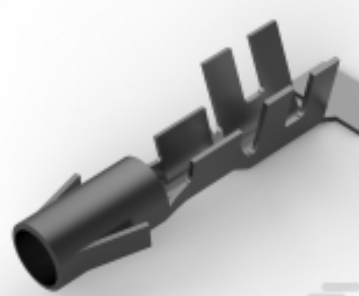
 <p>TE Part # 925663-1 .140 DIA SOCKET</p>	 <p>TE Part # 925661-2 .140 DIA SOCKET</p>	 <p>TE Part # 350390-1 .140 DIA SOK 14-10 PTPBR L/P</p>	 <p>TE Part # 925714-2 MATENLOK SOCKET.140</p>
 <p>TE Part # 350200-2 .140 DIA SOK 14-10 PTPPHBZ</p>	 <p>TE Part # 350200-1 .140 DIA SOK 14-10 PTPBR</p>	 <p>TE Part # 880687-2 .140 DIA SOCKET</p>	 <p>TE Part # 61626-2 .140 DIA SOK 20-14 PTPPHBZ</p>
 <p>TE Part # 61626-1 .140 DIA SOK 20-14 PTPBR</p>	 <p>TE Part # 925712-1 .140 DIA SOCKET</p>	 <p>TE Part # 925714-1 MATENLOK SOCKET</p>	 <p>TE Part # 350388-1 .140 DIA SOK 20-14 PTPBR L/P</p>



Also in the Series | Commercial MATE-N-LOK

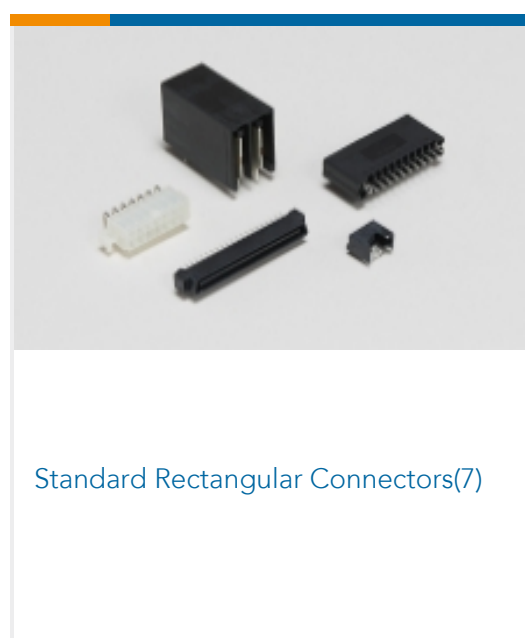
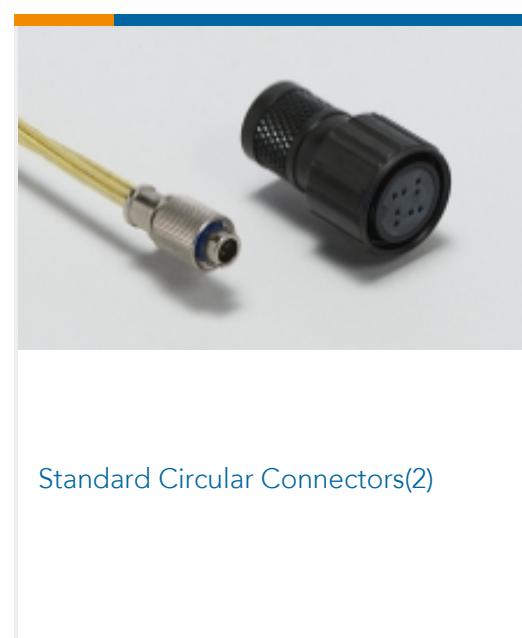
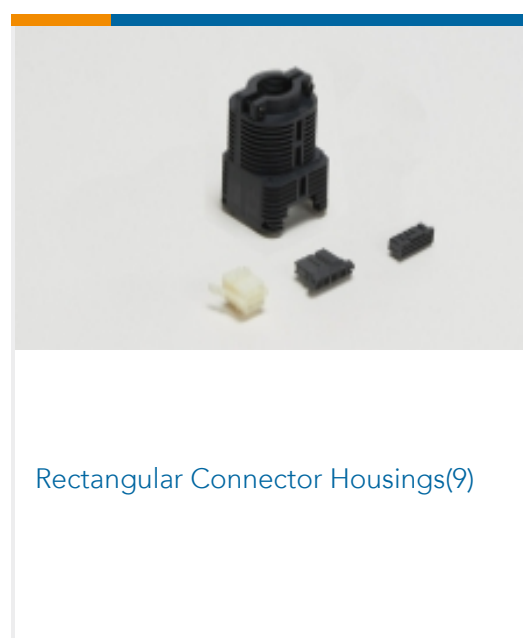
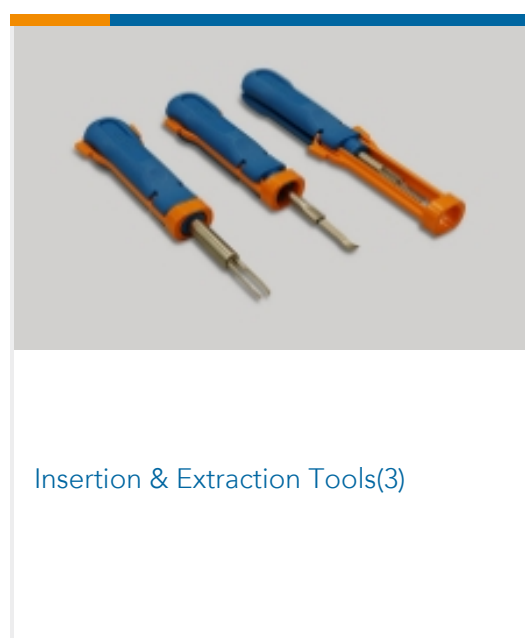
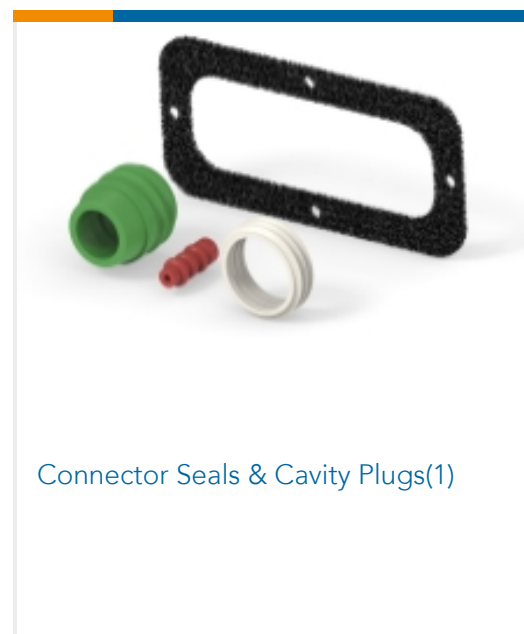
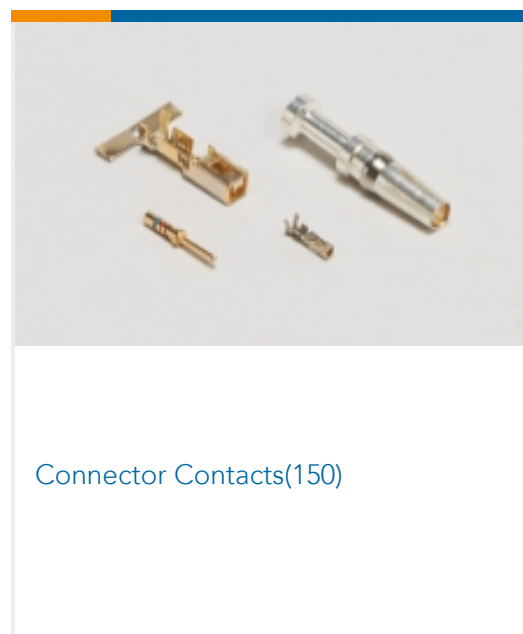
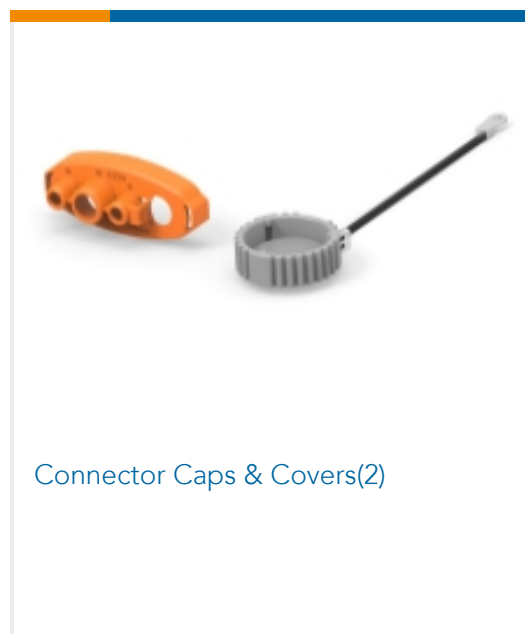

Customers Also Bought

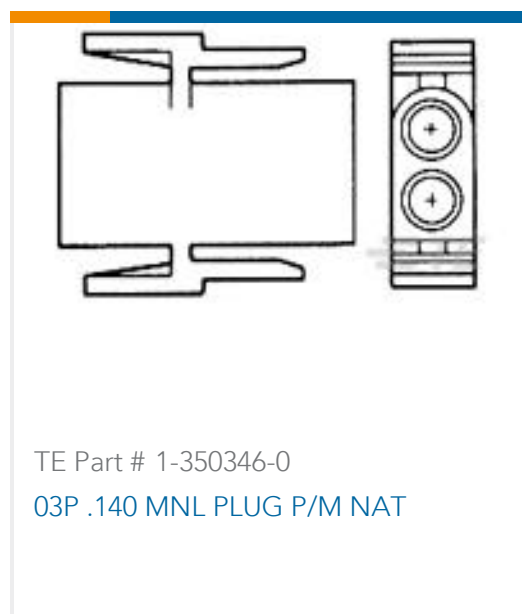

TE Part # 1-350346-0
03P .140 MNL PLUG P/M NAT

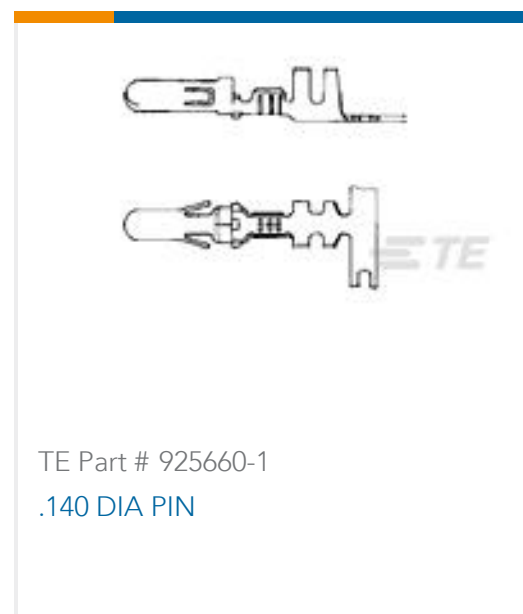

TE Part # 925660-1
.140 DIA PIN

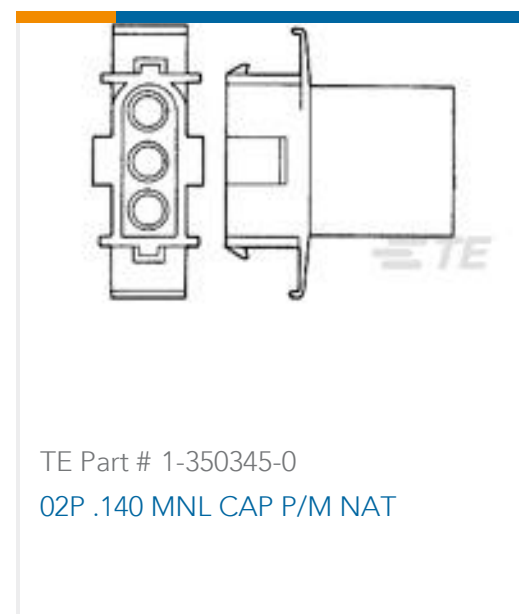

TE Part # 1-350345-0
02P .140 MNL CAP P/M NAT



TE Part # 3-826629-6
1X36 POS AMPMODU II HEADER



TE Part # 1-968855-1
AMP MCP, RECEPTACLE AND TAB

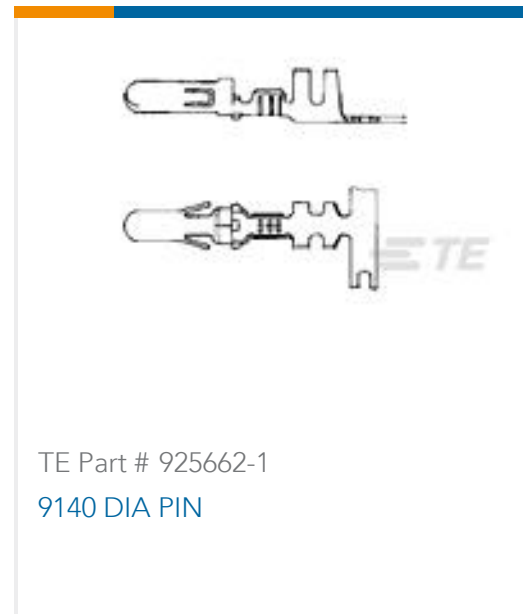

TE Part # 925662-1
9140 DIA PIN



TE Part # 925450-1
M-N-L PIN HSG



TE Part # 1-963749-1
TAB TAB 1.0-2.5 MM2 PTPPHBZ

Documents

Product Drawings

M-N-L SOCKET HSG

English

CAD Files

3D PDF

English

Customer View Model

[ENG_CVM_925451-1_B.2d_dxf.zip](#)

English

Customer View Model

[ENG_CVM_925451-1_B.3d_igs.zip](#)

English

Customer View Model

[ENG_CVM_925451-1_B.3d_stp.zip](#)

English

By downloading the CAD file I accept and agree to the [Terms and Conditions](#) of use.

Product Specifications

Product Specification

English