

2138846-1 ✓ ACTIVE

DEUTSCH | AMPSEAL 16

TE Internal #: 2138846-1

Cap, Wire-to-Wire, 28 Position, .209 in [5.3 mm] Centerline,
Sealable, Black, Wire & Cable, Power, Cable Mount (Free-Hanging),
AMPSEAL 16

[View on TE.com >](#)



Connectors > Automotive Connectors > Automotive Housings > AMPSEAL 16 Hybrid Lever Housings

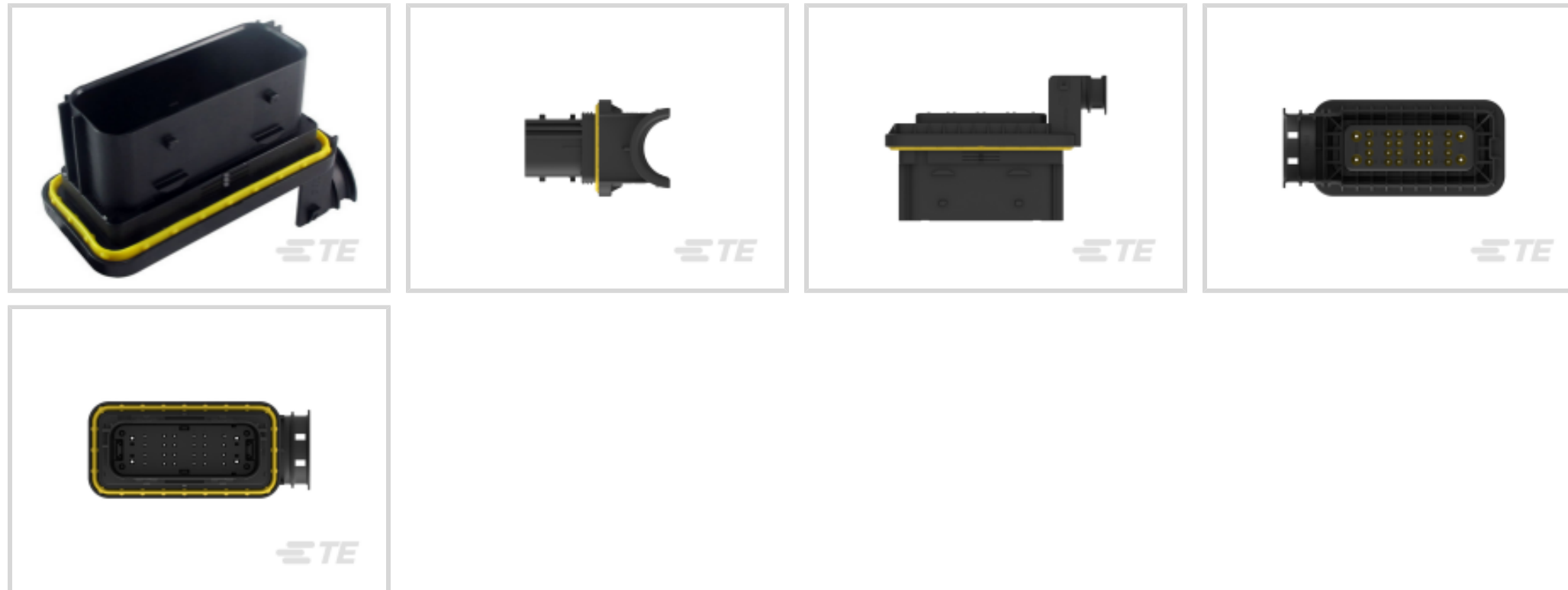

Connector System: **Wire-to-Wire**

Number of Positions: **28**

Connector & Housing Type: **Cap**

Centerline (Pitch): **5.3 mm [.209 in]**

Sealable: **Yes**

[All AMPSEAL 16 Hybrid Lever Housings \(10\)](#)

Features

Product Type Features

Mixed & Hybrid Connector	Yes
Connector Shape	Rectangular
Connector System	Wire-to-Wire
Connector & Housing Type	Cap
Sealable	Yes
Connector & Contact Terminates To	Wire & Cable
Primary Locking Feature	Integrated in Housing

Configuration Features

Number of Positions	28
Number of Rows	4

Electrical Characteristics

Operating Voltage	550 VDC
-------------------	---------



Body Features

Cable Exit Angle	90°
Primary Product Color	Black
Connector & Keying Code	A

Contact Features

Contact Size	Size 12, Size 16
Mating Pin Diameter	1.5 mm, 2.4 mm [.062 in] [.095 in]
Contact Current Rating (Max)	13 A, 25 A

Mechanical Attachment

Terminal Position Assurance	Yes
Strain Relief	With
Mating Alignment Type	Keyed
Mating Alignment	With
Connector Mounting Type	Cable Mount (Free-Hanging)

Housing Features

Housing Material	PBT GF20
Centerline (Pitch)	5.3 mm [.209 in]

Dimensions

Connector Height	72.7 mm [2.86 in]
Product Width	48.4 mm [1.9 in]
Product Length	111.2 mm [4.38 in]
Row-to-Row Spacing	11.7 mm, 4.7 mm [.185 in] [.46 in]

Usage Conditions

Operating Temperature (Max)	125 °C [257 °F]
Operating Temperature Range	-55 - 125 °C [-67 - 257 °F]

Operation/Application

Circuit Application	Power
---------------------	-------

Industry Standards

UL Flammability Rating	UL 94HB
------------------------	---------

Packaging Features

Packaging Quantity	10
Packaging Method	Tray



Other

Serviceable	Yes
Connector Position Assurance Capable	No

Product Compliance

[For compliance documentation, visit the product page on TE.com>](#)

EU RoHS Directive 2011/65/EU	Compliant
EU ELV Directive 2000/53/EC	Compliant
China RoHS 2 Directive MIIT Order No 32, 2016	No Restricted Materials Above Threshold
EU REACH Regulation (EC) No. 1907/2006	Current ECHA Candidate List: JAN 2024 (240) Candidate List Declared Against: JAN 2024 (240) Does not contain REACH SVHC
Halogen Content	Low Halogen - Br, Cl, F, I < 900 ppm per homogenous material. Also BFR/CFR/PVC Free
Solder Process Capability	Not applicable for solder process capability

Product Compliance Disclaimer

This information is provided based on reasonable inquiry of our suppliers and represents our current actual knowledge based on the information they provided. This information is subject to change. The part numbers that TE has identified as EU RoHS compliant have a maximum concentration of 0.1% by weight in homogenous materials for lead, hexavalent chromium, mercury, PBB, PBDE, DBP, BBP, DEHP, DIBP, and 0.01% for cadmium, or qualify for an exemption to these limits as defined in the Annexes of Directive 2011/65/EU (RoHS2). Finished electrical and electronic equipment products will be CE marked as required by Directive 2011/65/EU. Components may not be CE marked. Additionally, the part numbers that TE has identified as EU ELV compliant have a maximum concentration of 0.1% by weight in homogenous materials for lead, hexavalent chromium, and mercury, and 0.01% for cadmium, or qualify for an exemption to these limits as defined in the Annexes of Directive 2000/53/EC (ELV). Regarding the REACH Regulation, the information TE provides on SVHC in articles for this part number is based on the latest European Chemicals Agency (ECHA) 'Guidance on requirements for substances in articles' posted at this URL: <https://echa.europa.eu/guidance-documents/guidance-on-reach>

Compatible Parts



TE Part # CAT-H991-CH8172
AMPSEAL 16 Hybrid Lever Housings



TE Part # CAT-H991-M8649
AMPSEAL 16 Hybrid Lever Mounting



TE Part # 2138853-1
WIRE EXIT COVER, AMPSEAL 16 HL



TE Part # 776106-1
EXTRACTION TOOL

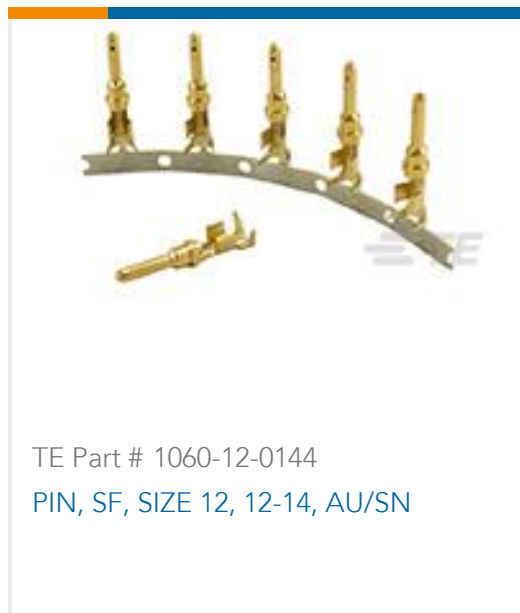

Also in the Series | AMPSEAL 16

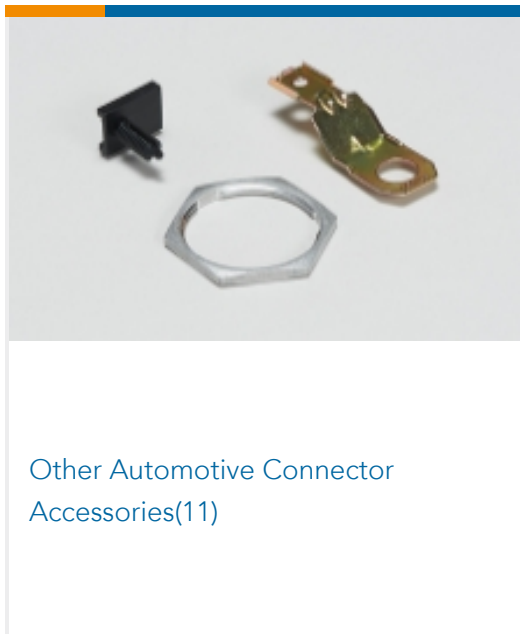
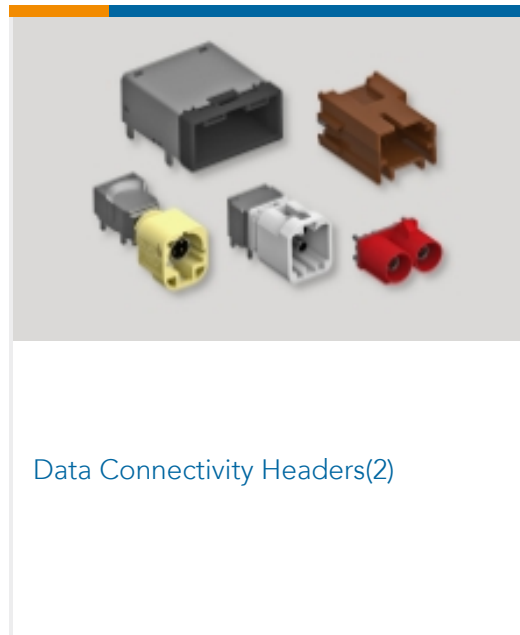
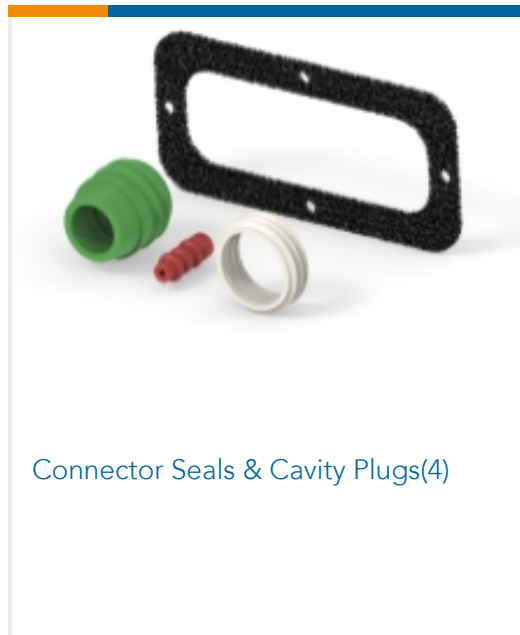
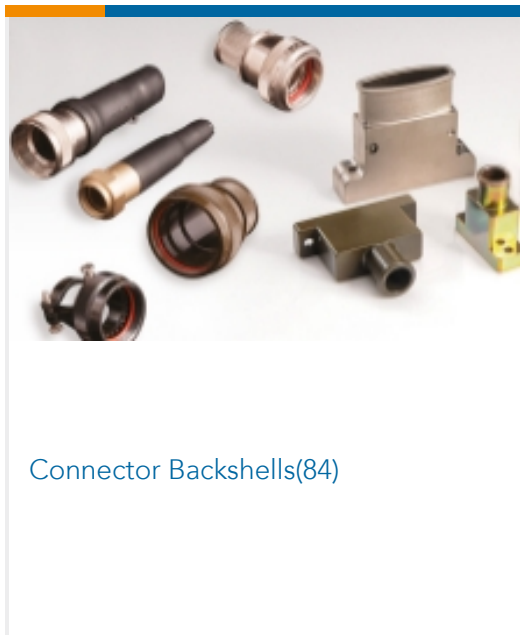
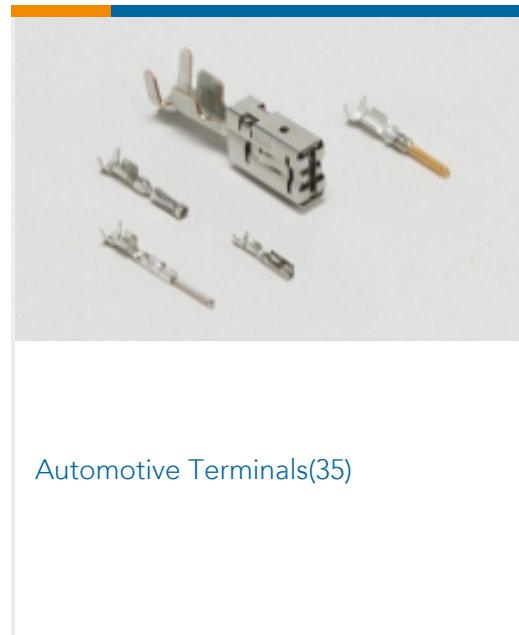
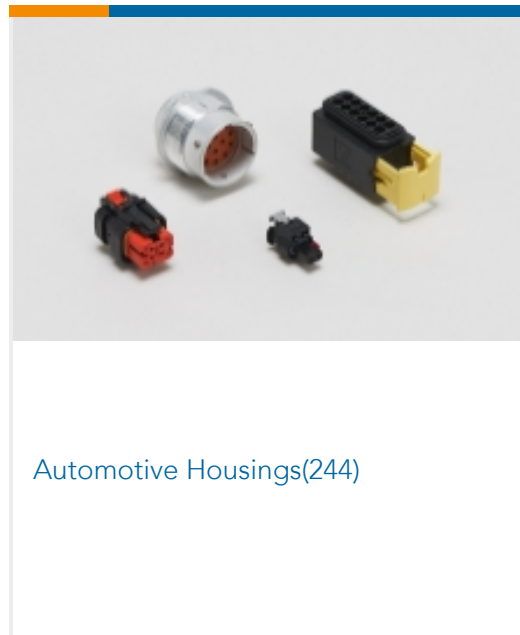
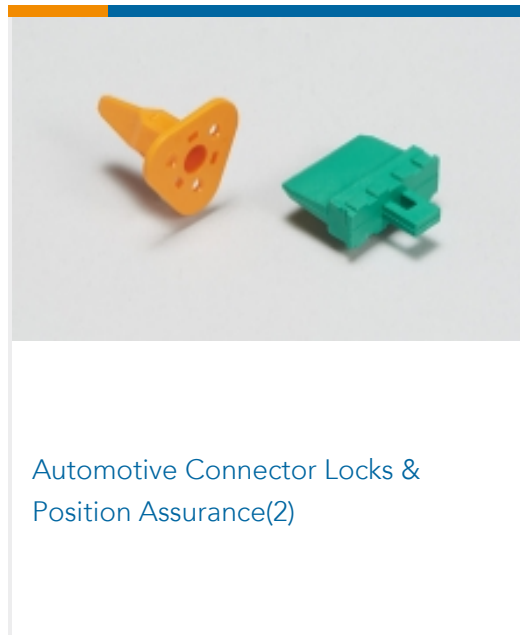
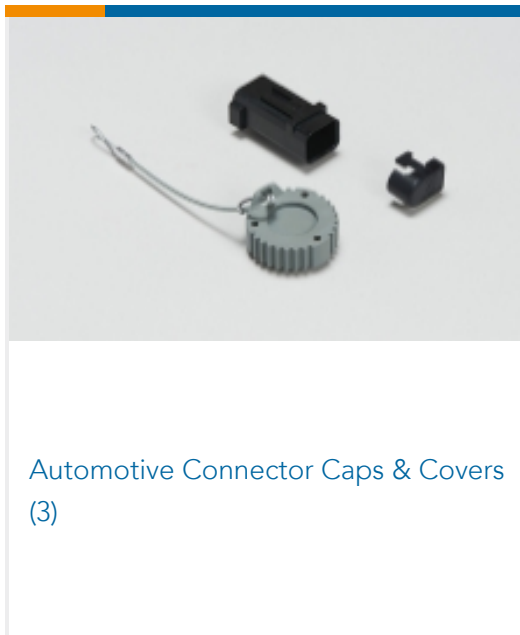

Customers Also Bought





Documents

Product Drawings

[CAP ASSY, 28 POS, KEY A, AMPSEAL 16 HL](#)

English

CAD Files

[3D PDF](#)

3D

Customer View Model

[ENG_CVM_CVM_2138846-1_B.2d_dxf.zip](#)

English

Customer View Model

[ENG_CVM_CVM_2138846-1_B.3d_igs.zip](#)

English

Customer View Model

[ENG_CVM_CVM_2138846-1_B.3d_stp.zip](#)

English

By downloading the CAD file I accept and agree to the [Terms and Conditions](#) of use.

Datasheets & Catalog Pages

["AMPSEAL 16 HL" \(ICT\)](#)

English

[ICT Terminals and Connectors Catalogue](#)

English

[CONNECTOR SELECTOR](#)

English

Product Specifications

[Engineering Report](#)

English