

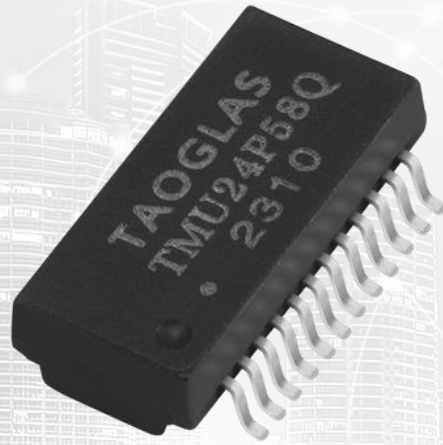

TAOGLAS®



Datasheet

LAN Transformer 5G Base-T PoE++

Part No:
TMU24P58Q

Description:

5G Base-T transformer
Single Port and 24pin SMT

Features:

PoE++
CMC + Transformer
Industrial grade

1.	Introduction	3
2.	Specifications	4
3.	Mechanical	5
4.	Electrical	6
5.	Packaging	7
<hr/>		
	Changelog	8

Taoglas makes no warranties based on the accuracy or completeness of the contents of this document and reserves the right to make changes to specifications and product descriptions at any time without notice. Taoglas reserves all rights to this document and the information contained herein. Reproduction, use or disclosure to third parties without express permission is strictly prohibited.



1. Introduction

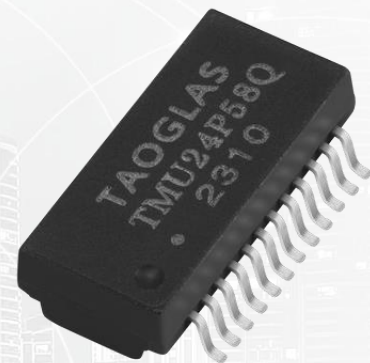

Featuring a compatible footprint with industry LAN Transformers, and designed to work in demanding industrial environmental conditions, the Taoglas TMU24P58Q is a 5G Base-T Single Port of 24pin with Common Mode Choke and Transformer designed for PoE++ (720mA) capabilities.

Typical applications for this cost-effective part are:

- Industrial Automation
- Hubs
- Routers
- Switches
- Wireless Access Points

The Taoglas Magnetics Product Team have over fifteen years of LAN magnetics design and high-quality manufacturing. With an ever-expanding portfolio, we provide trusted products and services to customers within a wide range of applications such as: Networking and Interconnect Devices, Servers, Switches, Router, Communication systems and any Digital Consumer electronics.

The Taoglas Exos Series offer an extensive product line of LAN Transformers designed for commercial and industrial grade applications, supporting 10/100 Base-T (Exos100 Series), 1G Base-T (Exos1G Series) and 10G Base-T (Exos10G Series). These products include Single, Dual, and Quad configurations not only for standard applications but also for Power over Ethernet (PoE, PoE+, PoE++).

For more information on the range of products or for assistance with integration, contact your regional Taoglas customer support team.

2. Specifications

Electrical Performance @25°C	
Inductance OCL	180uH Min. @100KHz/0.1V with 10.8mA DC Bias
Turns Ratio (±3%)	TX=1CT: 1CT RX=1CT: 1CT
D.C.R:	1.0 ohm Max
Insertion Loss	-1.0dB Max@1-100MHz
	-2.0dB Max@100-250MHz
Return Loss	-16dB Min @1-40MHz
	-16+10log(f/40)dB Min@40-250MHz
Crosstalk	-30dB Min@1-125MHz
	-25dB Min@125-250MHz
Hi-Pot	1500Vrms
PoE	End-span PoE applications with 720mA current capability

Environmental Specifications	
Operating Temperature	-40°C TO +85°C

Compliance	
UL recognized - FILE NO. E528697	
RoHS Compliant	

Storage requirements	
Humidity	MSL - 1
Storage Temperature	-40°C TO +125°C

3. Mechanical

3.1 Mechanical Drawings

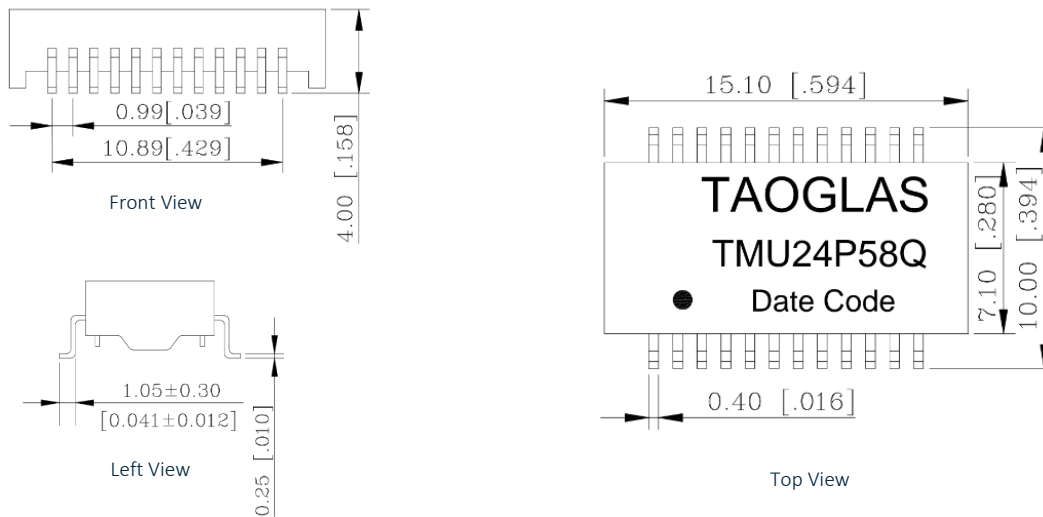

Mechanical Specifications

Length	15.1 mm
Width	10 mm
Height	4 mm
Mounting Style	Surface Mount (SMT)

Dimensions are in millimeters with the following tolerances: X.XX = ±0.25

3.2 Pad Layout

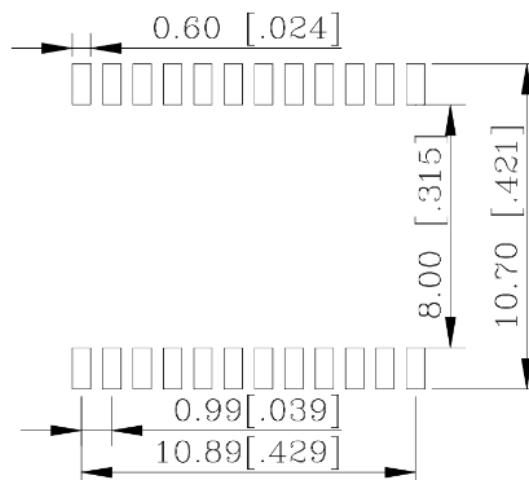

Suggested pad layout

Dimensions are in millimeters with the following tolerances: X.XX = ±0.10

4. Electrical

4.1 Electrical Drawings

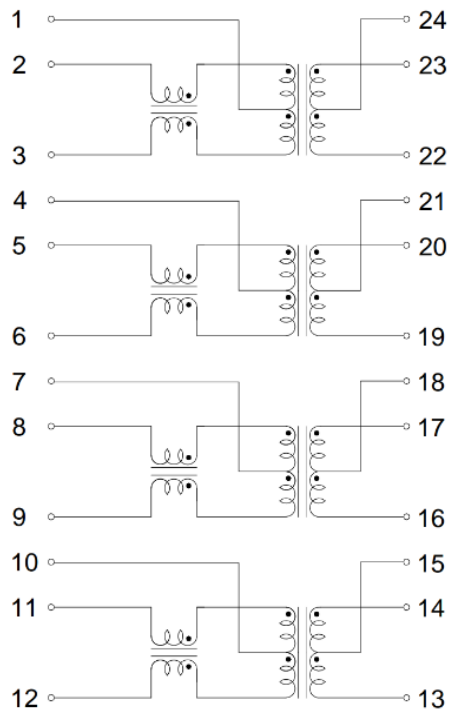

4.2 Profile of Reflow Solder

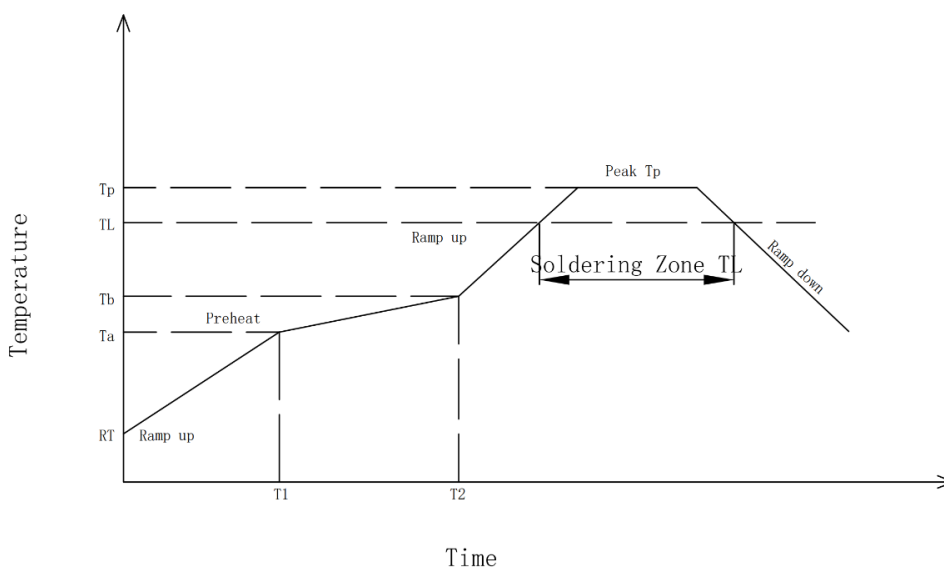

Preheat :

Temperature (Ta-Tb):150-200°C

Time(T1-T2):60-180s

Holding Temperature:217°C

Time (TL):60-150s

Max Temperature (Tp):250(+0/-5°C)

Max Time (Tp):30Sec±10Sec

The average speed:3°C/S Max

The average cooling speed:6°C/S Max

From 25°C to Products out of the furnace:6 minutes Max

5. Packaging

5.1 SPQ

1 reel = 650 pcs
 Reel (mm): 24x10.25x11.6
 Weight (gr): 770

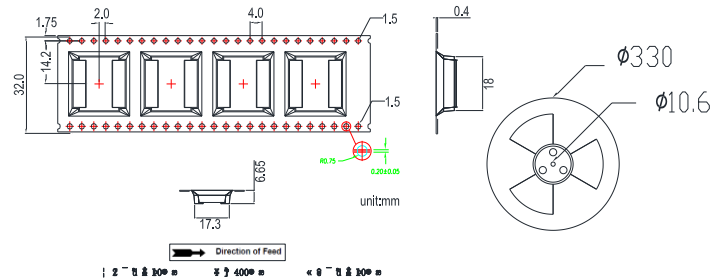

1 Carton = 9 reels = 5850 pcs
 Carton dimensions: 373*365*284 mm
 Carton Weight: 8.45 kg



5.2 Label

Taoglas Limited	
P/N NO: XXXXXXXX	
QYT: XXX PCS	DC: XXXX
DATE: XXXX-XX-XX	

SPQ Label (8x5cm)

Taoglas Limited	
P/N NO: XXXXXXXX	
PO: XXXXXXXX	B/N: XXXXXXXX
QYT: XXX PCS	DC: XXXX
DATE: XXXX-XX-XX	

Carton Label (8x5cm)

Changelog

Changelog for the datasheet

SPE-23-8-060 – TMU24P58Q

Revision: A (Original First Release)

Date:	2023-03-30
Notes:	
Author:	Javier Vasena

Previous Revisions



www.taoglas.com

