

400 pts solder-in breadboard (Exact Solderless Match)

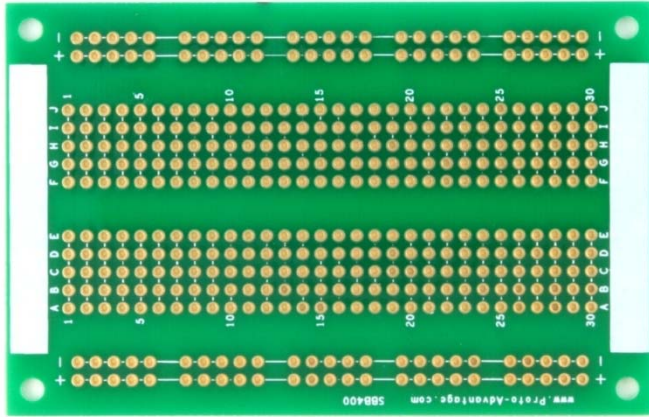

Top view

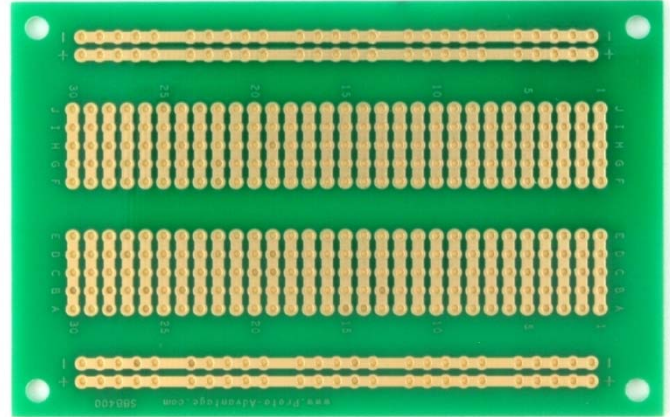

Bottom view

Product Highlights

Immersion Gold Finish

All holes are gold plated and are on a 0.1" grid. Column E-F hole-center to hole-center spacing is 0.3" (7.62mm).

1/16" (1.6mm) thick FR-4 UL94V-0

Accepts a variety of wire sizes (20-32 AWG)

4 mounting holes

Two rectangular silkscreen areas that you can write on using pencil or pen

Usage

This board exactly copies the routing of a 400 pts 1/2 size solderless breadboard.

Allows direct transfer of circuits prototyped in a solderless breadboard to a solder-in breadboard to facilitate functional in-system testing or field testing.

Specifications

Wiring Pattern:

2 Distribution Strips
1 Terminal Strip
100 Distribution Holes
300 Terminal Holes

Dimensions:

3.6" x 2.3" x 0.0625" (91.44mm x 58.42mm x 1.6mm)

PCB construction:

FR-4 UL94V-0

PCB operating temperature range:

-40°C to +130°C (-40°F to +266°F)

PCB reflow maximum temperature:

+260°C (500°F)

PCB trace width:

0.059" (1.5mm)

PCB trace thickness:

1 oz copper / ft² (1.4 mils) (0.03556 mm)

PCB trace current capacity*:

10A continuous @ 40°C rise, 13A continuous @ 80°C rise*

Recommended pin size:

25 mil square wire wrap posts or smaller

Diameter of 4 corner mounting holes:

3.2mm (125 mils)

* Derived from IPC-2221 current capacity graphs at 25°C ambient temperature. Actual current capacity will vary based on air flow, component density, and other factors.

Top View of SBB400

Topside silkscreen lines between holes show where bottom traces electrically connect holes.

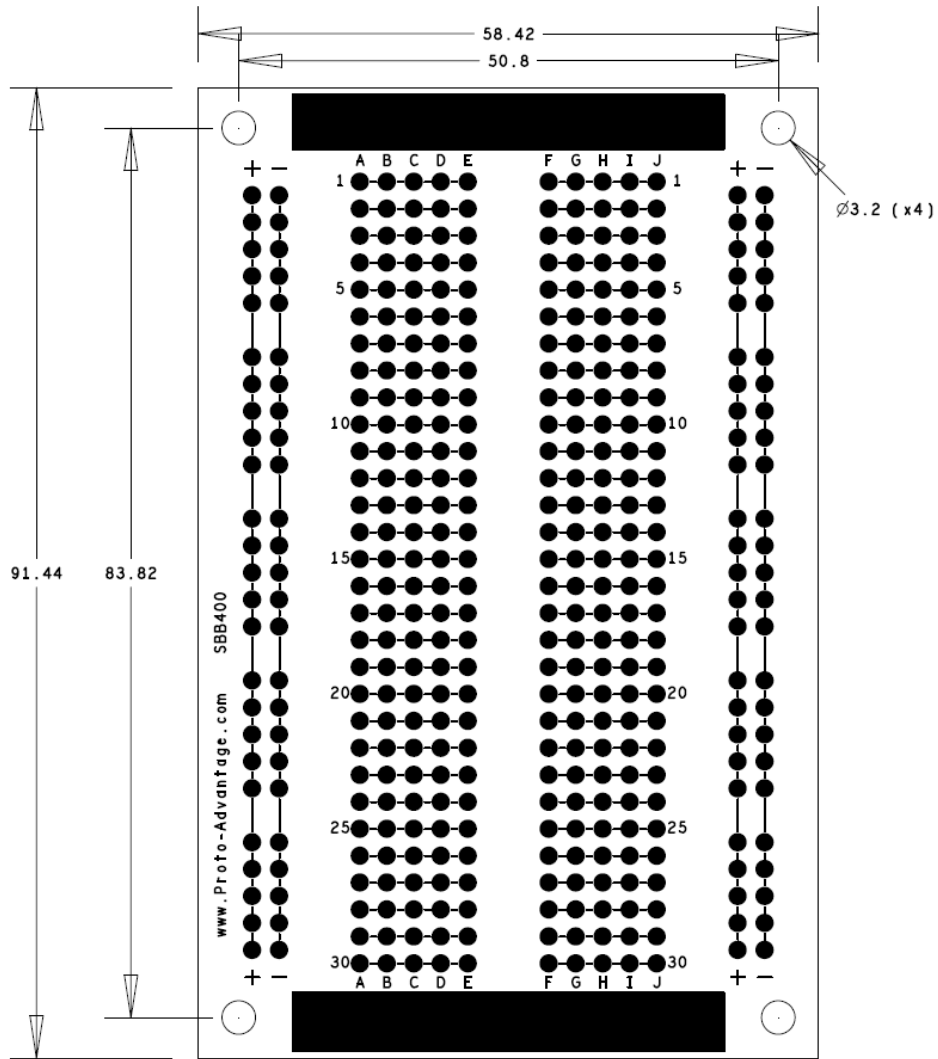

(Representative drawing only - not to scale)

Complete Line of Proto Advantage Exact Solderless Match Solder-in Breadboards:

Tiny breadboard match (P/N: **SBB170**)

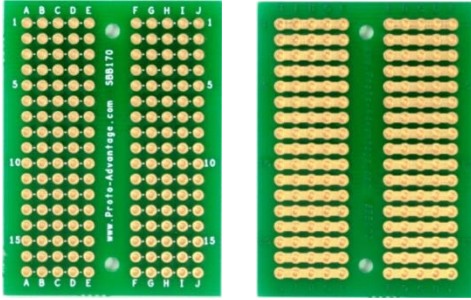

Full size breadboard match (P/N: **SBB830**)

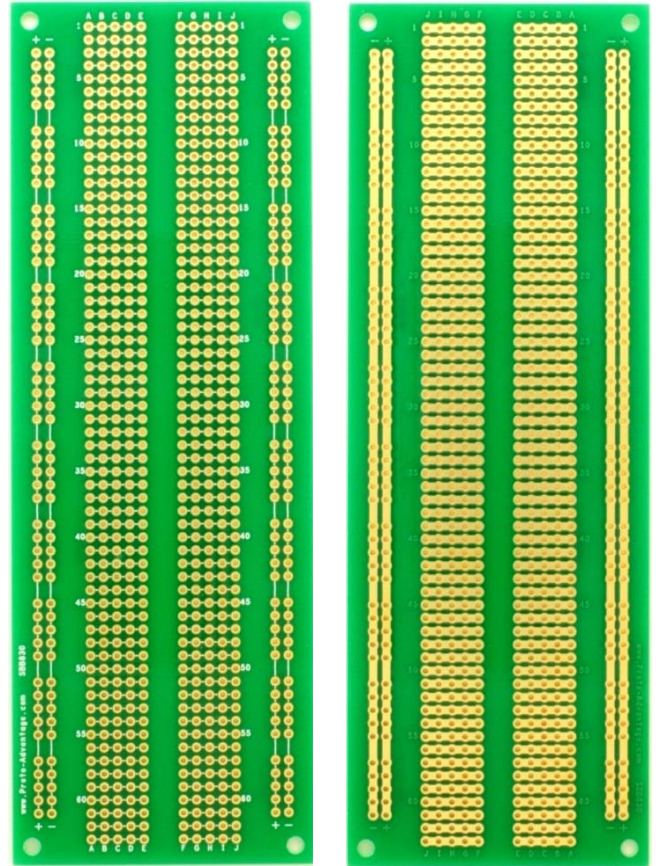

1/6 size breadboard match (P/N: **SBB136**)

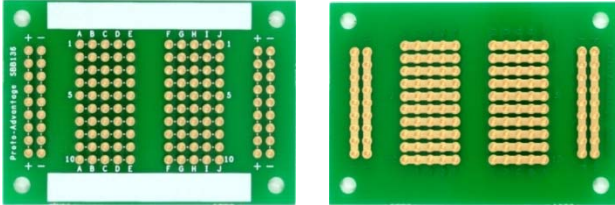

1/4 size breadboard match (P/N: **SBB206**)

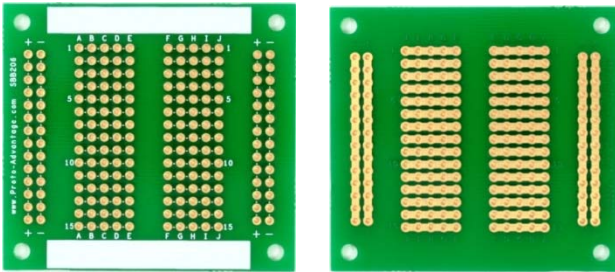

1/2 size breadboard match (P/N: **SBB400**)

