

REL-MR- 24AC/21HC/MS - Single relay



2987891

<https://www.phoenixcontact.com/us/products/2987891>

Please be informed that the data shown in this PDF document is generated from our online catalog. Please find the complete data in the user documentation. Our general terms of use for downloads are valid.



Plug-in miniature relay, with power contact, 1 changeover contact, test button, mechanical switching position indicator, status LED, input voltage 24 V AC

Your advantages

- With detectable manual operation
- Switching current of up to 16 A
- Integrated status LED
- Mechanical switch position indicator
- DC types with integrated freewheeling diode

Commercial data

Item number	2987891
Packing unit	10 pc
Minimum order quantity	10 pc
Sales key	C460
Product key	CK6195
Catalog page	Page 292 (C-5-2019)
GTIN	4046356481021
Weight per piece (including packing)	19.57 g
Weight per piece (excluding packing)	18.34 g
Customs tariff number	85364190
Country of origin	CN

REL-MR- 24AC/21HC/MS - Single relay



2987891

<https://www.phoenixcontact.com/us/products/2987891>

Technical data

Product properties

Product type	Single relay
Mechanical service life	5x 10 ⁶ cycles

Electrical properties

Service life electrical	see diagram
Maximum power dissipation for nominal condition	0.77 W
Test voltage (Winding/contact)	5 kV AC (50 Hz, 1 min., winding/contact)

Input data

Coil side

Nominal input voltage U _N	24 V AC
Input voltage range	18.7 V AC ... 34.8 V AC
Mains frequency	50/60 Hz
Drive and function	monostable
Drive (polarity)	non-polarized
Typical input current at U _N	32 mA
Typical response time	3 ms ... 12 ms (depending on phase relation)
Typical release time range	2 ms ... 8 ms (depending on phase relation)

Output data

Switching

Contact switching type	1 changeover contact
Type of switch contact	Single contact
Contact material	AgNi
Maximum switching voltage	250 V AC/DC
Minimum switching voltage	12 V (at 10 mA)
Limiting continuous current	16 A
Maximum inrush current	32 A (20 ms)
Min. switching current	10 mA (at 12 V)
Interrupting rating (ohmic load) max.	4000 VA (for 250 V AC)
Switching capacity	2 A (at 24 V, DC13)
	3 A (at 24 V, AC15)
	3 A (at 120 V, AC15)
	3 A (at 240 V, AC15)
Motor load according to UL 508	1/2 HP, 120 V AC (N/O contact)
	1 HP, 240 V AC (N/O contact)
	1/3 HP, 120 V AC (N/C contact)
	1/2 HP, 240 V AC (N/C contact)

Connection data

REL-MR- 24AC/21HC/MS - Single relay



2987891

<https://www.phoenixcontact.com/us/products/2987891>

Connection method	Plug / solder connection
-------------------	--------------------------

Dimensions

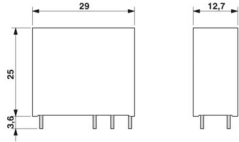
Dimensional drawing	
Width	12.7 mm
Height	29 mm
Depth	25 mm

Environmental and real-life conditions

Ambient conditions

Ambient temperature (operation)	-40 °C ... 70 °C
Ambient temperature (storage/transport)	-40 °C ... 85 °C

Approvals

Corrosive gas test

Identification	ISA-S71.04. G3 Harsh Group
	EN 60068-2-60

Standards and regulations

Standards/regulations	EN 61810-1
	VDE 0435-201
	EN 50178

Drawings

Diagram

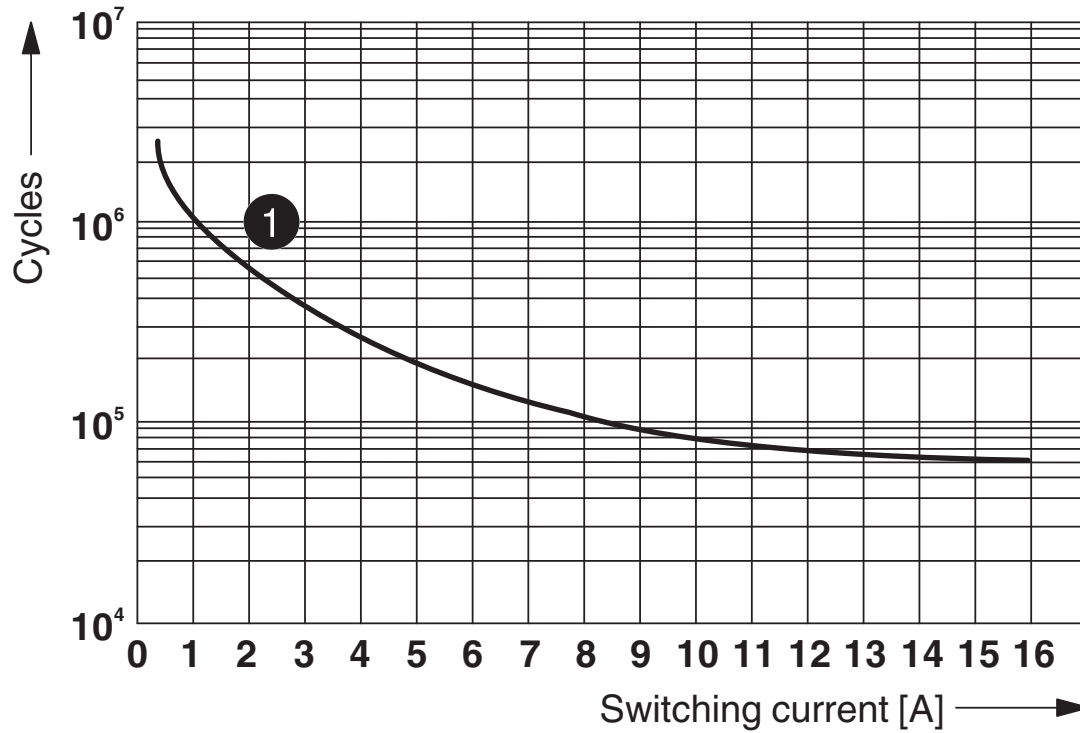

① 250 V AC, ohmic load

Electrical service life

Diagram

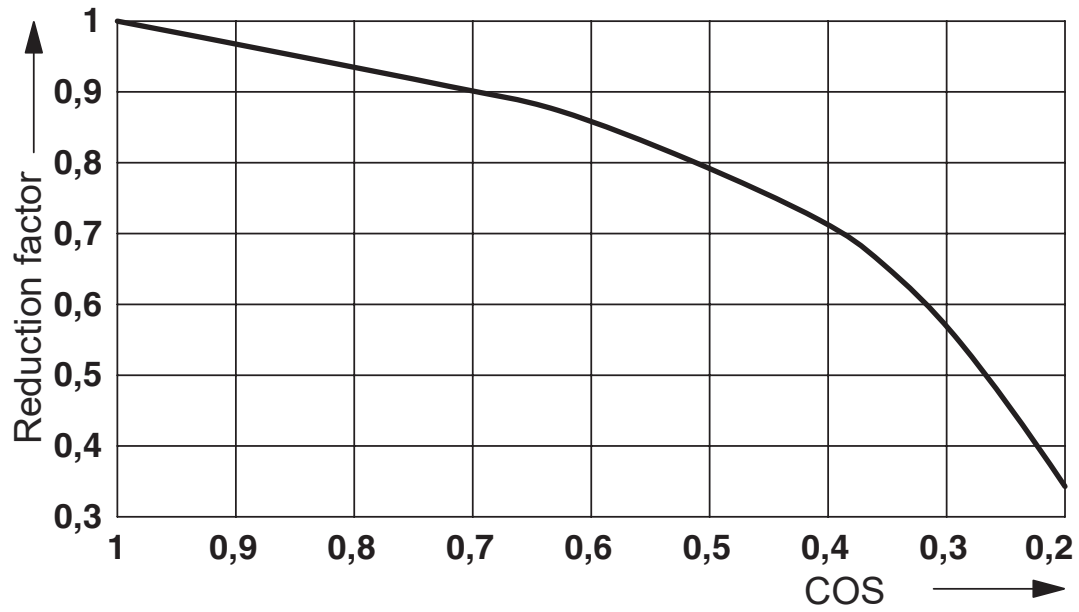

Service life reduction factor with various cos phi

Diagram

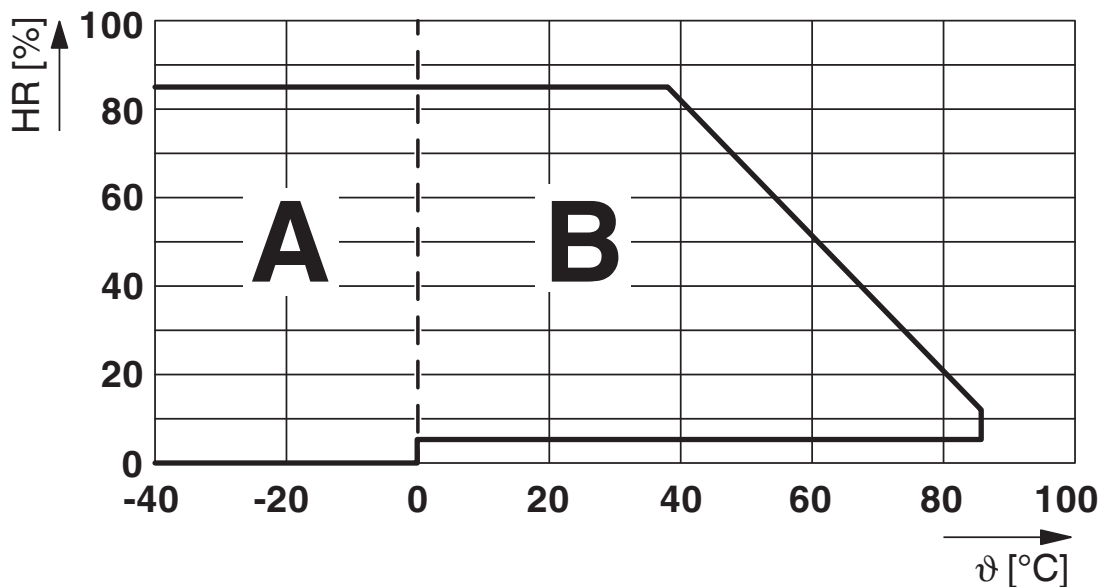

Permissible humidity for operation and storage.

The maximum permissible ambient temperature as specified in the data sheet must be observed.

Area A: Ice buildup at ambient temperatures $\leq 0^{\circ}\text{C}$ must be prevented

Area B: Condensation at ambient temperatures $> 0^{\circ}\text{C}$ must be prevented

On 30 full days that are naturally distributed across an entire year, a humidity level of 95% is permissible at an ambient temperature $\leq 25^{\circ}\text{C}$.

Circuit diagram

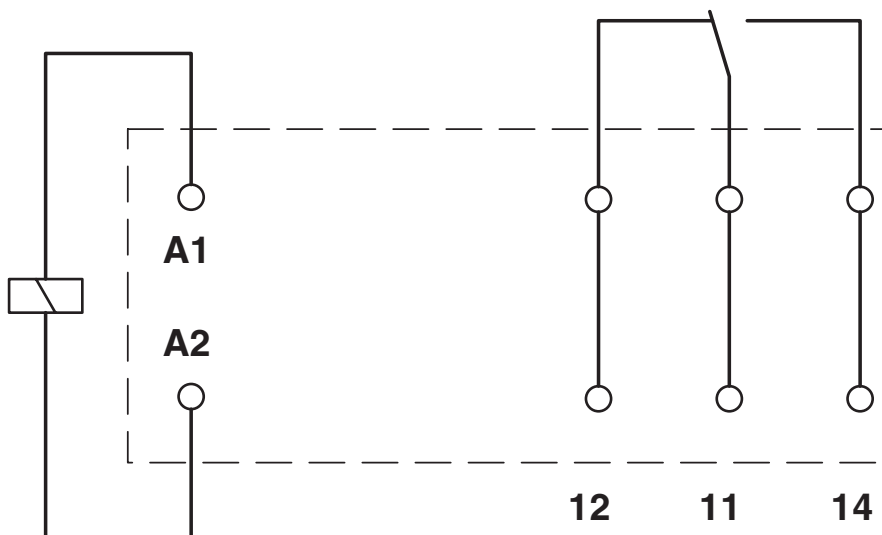

REL-MR- 24AC/21HC/MS - Single relay



2987891

<https://www.phoenixcontact.com/us/products/2987891>

Diagram

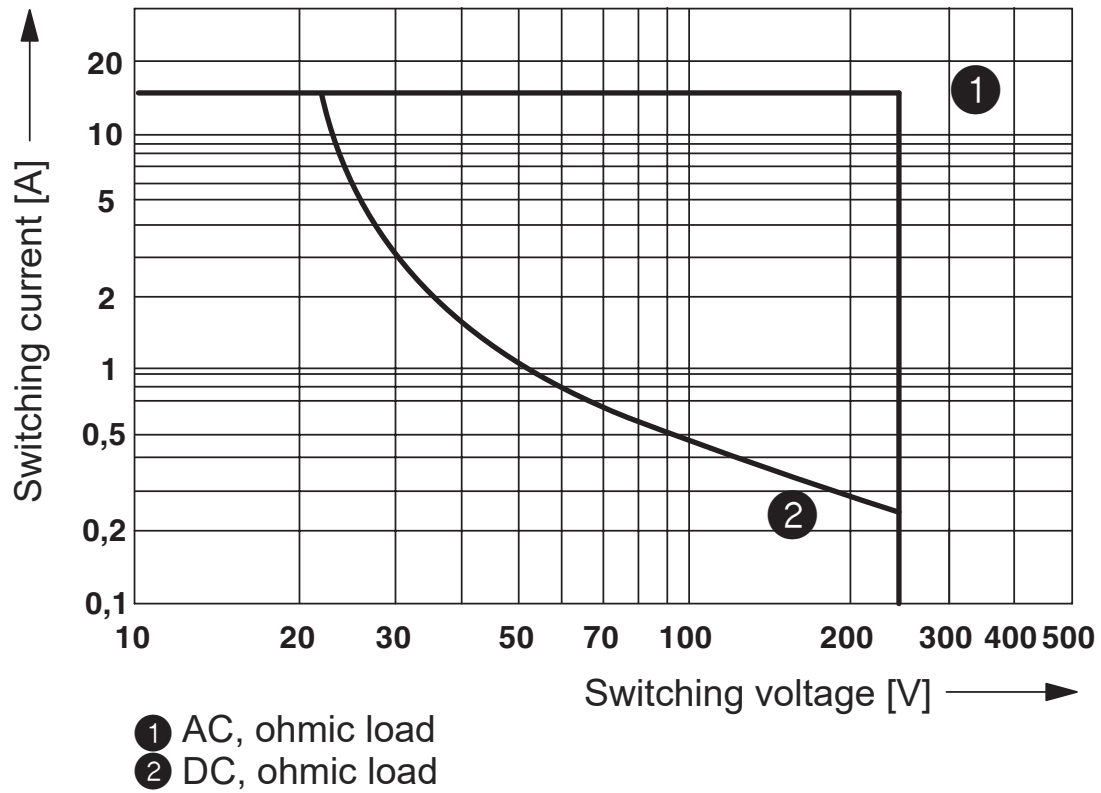

Interrupting rating

2987891

<https://www.phoenixcontact.com/us/products/2987891>

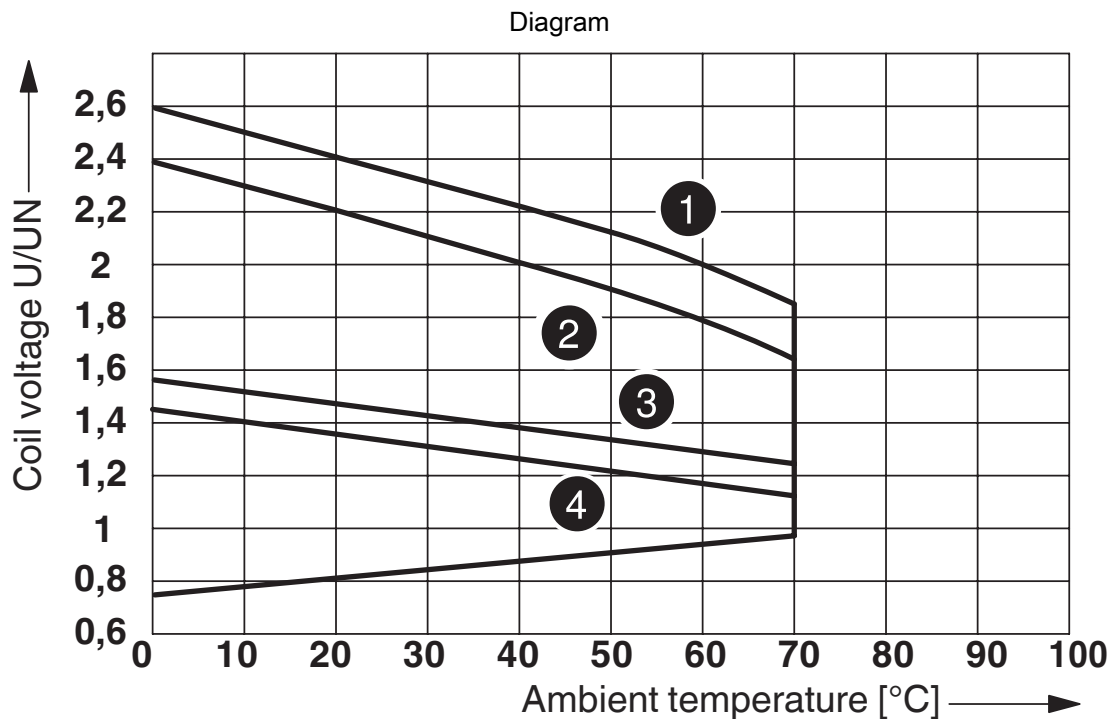

- ① DC coils, 0 A contact current
- ② DC coils, 16 A contact current
- ③ AC coils, 0 A contact current
- ④ AC coils, 16 A contact current

Operating voltage range

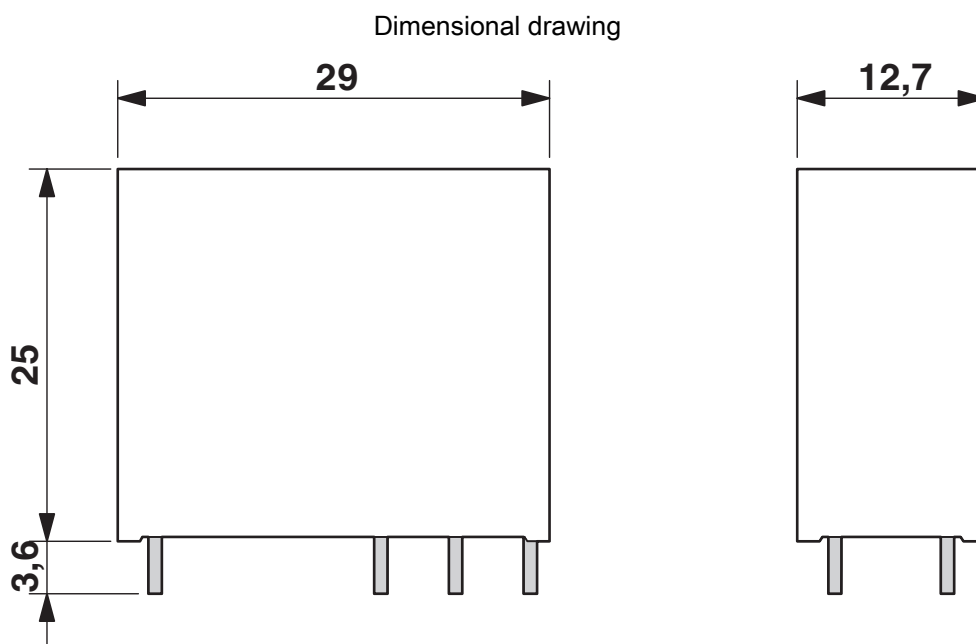

REL-MR- 24AC/21HC/MS - Single relay



2987891

<https://www.phoenixcontact.com/us/products/2987891>

Approvals

To download certificates, visit the product detail page: <https://www.phoenixcontact.com/us/products/2987891>



cUL Recognized
Approval ID: FILE E 195083



UL Recognized
Approval ID: FILE E 195083



EAC
Approval ID: TR_TS_D_00573_c



EAC
Approval ID: RU*C-DE.*08.B.00010



VDE Zeichengenehmigung
Approval ID: 40027210

cULus Recognized

REL-MR- 24AC/21HC/MS - Single relay



2987891

<https://www.phoenixcontact.com/us/products/2987891>

Classifications

ECLASS

ECLASS-11.0	27371601
ECLASS-12.0	27371601
ECLASS-13.0	27371601

ETIM

ETIM 9.0	EC001437
----------	----------

UNSPSC

UNSPSC 21.0	39122300
-------------	----------

REL-MR- 24AC/21HC/MS - Single relay



2987891

<https://www.phoenixcontact.com/us/products/2987891>

Environmental product compliance

EU RoHS

Fulfills EU RoHS substance requirements	Yes, No exemptions
---	--------------------

China RoHS

Environment friendly use period (EFUP)	EFUP-E
	No hazardous substances above the limits

EU REACH SVHC

REACH candidate substance (CAS No.)	No substance above 0.1 wt%
-------------------------------------	----------------------------

REL-MR- 24AC/21HC/MS - Single relay



2987891

<https://www.phoenixcontact.com/us/products/2987891>

Mandatory accessories

RIF-1-BPT/2X21 - Relay base

2900931

<https://www.phoenixcontact.com/us/products/2900931>



Relay base RIF-1..., for miniature power relay with 1 or 2 changeover contacts or solid-state relays of the same design, Push-in connection, plug-in option for input/interference suppression modules, for mounting on NS 35/7,5

RIF-1-BSC/2X21 - Relay base

2900930

<https://www.phoenixcontact.com/us/products/2900930>



RIF-1... relay base, for miniature power relay with 1 or 2 changeover contacts or identical solid-state relays, screw connection, plug-in option for input/interference suppression modules, for mounting on NS 35/7,5

Phoenix Contact 2024 © - all rights reserved

<https://www.phoenixcontact.com>

Phoenix Contact USA
586 Fulling Mill Road
Middletown, PA 17057, United States
(+717) 944-1300
info@phoenixcon.com