

PLC-RPT- 24DC/ 1ICT/ACT - Relay Module



1078683

<https://www.phoenixcontact.com/us/products/1078683>

Please be informed that the data shown in this PDF document is generated from our online catalog. Please find the complete data in the user documentation. Our general terms of use for downloads are valid.



PLC-INTERFACE for high inrush currents, consisting of PLC-BPT.../1 IC/ACT basic terminal block with push-in connection and pluggable miniature relay, for mounting on DIN rail NS 35/7,5, max. inrush current up to 800 A, 1 N/O contact, input voltage 24 V DC

Product description

The relay module is particularly suitable for switching strong capacitive loads, such as LED lights. The ballasts installed in the LED lights often have extremely high switch-on peaks which cause standard relay contacts to fuse. The leading tungsten pre-contact ensures that switch-on currents of up to 800 A can be switched safely.

Your advantages

- Direct connection of load return line thanks to actuator version
- Efficient connection to system cabling using V8 adapter
- Safe isolation between coil and contact side
- Max. inrush current of 800 A
- Functional plug-in bridges

Commercial data

Item number	1078683
Packing unit	10 pc
Minimum order quantity	10 pc
Sales key	C461
Product key	CK62B6
Catalog page	Page 383 (C-5-2019)
GTIN	4055626794259
Weight per piece (including packing)	71.63 g
Weight per piece (excluding packing)	71.63 g
Customs tariff number	85364190
Country of origin	DE

Technical data

Notes

Notes on operation	Separating plate PLC-ATP must be installed for voltages larger than 250 V (L1, L2, L3) between identical terminal blocks in adjacent modules. Potential bridging is then carried out with FBST 8-PLC... or FBST 500....
Notes on operation	The PLC-ATP separating plate should be installed for safe isolation between adjacent modules
Assembly note	The PLC-ATP separating plate is required at the start and end of every PLC terminal strip.
Notes on operation	The system installer must ensure the touch protection of the product (at voltages > 25 V AC/60 V DC). The product is a built-in device without protection against direct contact.

Product properties

Product type	Relay Module
Product family	PLC-INTERFACE
Application	high inrush currents
Operating mode	100% operating factor
Mechanical service life	3x 10 ⁷ cycles

Insulation characteristics

Insulation	Safe isolation, reinforced insulation
------------	---------------------------------------

Insulation characteristics: Standards/regulations

Insulation	Safe isolation, reinforced insulation
Overvoltage category	III
Pollution degree	3

Electrical properties

Maximum power dissipation for nominal condition	0.43 W
Test voltage (Winding/contact)	4 kV AC (50 Hz, 1 min., winding/contact)

Standards/regulations

Rated insulation voltage	250 V AC
Rated surge voltage	6 kV

Input data

Coil side

Nominal input voltage U _N	24 V DC
Input voltage range	20.2 V DC ... 33.6 V DC (20 °C)
()	24 V DC
Drive and function	monostable
Drive (polarity)	polarized
Typical input current at U _N	18 mA

PLC-RPT- 24DC/ 1ICT/ACT - Relay Module



1078683

<https://www.phoenixcontact.com/us/products/1078683>

Typical response time	8 ms
Typical release time	10 ms
Coil voltage	24 V DC
Protective circuit	Reverse polarity protection; Polarity protection diode Surge protection; Freewheeling diode
Operating voltage display	Yellow LED

Output data

Switching

Contact switching type	1 N/O contact
Type of switch contact	Single contact
Note regarding the switch contact	With tungsten leading contact
Contact material	AgSnO
Note	Main contact silver tin oxide (AgSnO ₂): lead contact tungsten
Maximum switching voltage	250 V AC/DC
Minimum switching voltage	12 V (100 mA)
Limiting continuous current	6 A 10 A (the value is permissible if both connections 13, both connections 14 and both connections BB are bridged)
Maximum inrush current	165 A (20 ms) 800 A (200 µs)
Min. switching current	100 mA (12 V)
Interrupting rating (ohmic load) max.	144 W (at 24 V DC, observe contact derating) 58 W (at 48 V DC) 48 W (at 60 V DC) 50 W (at 110 V DC) 80 W (at 220 V DC) 1500 VA (for 250 V AC)
Interrupting rating (ohmic load) max. bridged	240 W (for 24 V DC. The value is permissible if both connections 13, both connections 14 and both connections BB are bridged.) 2500 VA (for 250 V AC. The value is permissible if both connections 13, both connections 14 and both connections BB are bridged.)
Switching capacity min.	1200 mW
Switching capacity	2 A (at 24 V, DC13) 0.2 A (at 110 V, DC13) 0.2 A (at 250 V, DC13) 6 A (at 24 V, AC15) 6 A (at 120 V, AC15) 6 A (at 250 V, AC15)

Connection data

Connection method	Push-in connection
Stripping length	10 mm
Conductor cross section rigid	0.14 mm ² ... 2.5 mm ²

PLC-RPT- 24DC/ 1ICT/ACT - Relay Module



1078683

<https://www.phoenixcontact.com/us/products/1078683>

Conductor cross section flexible	0.14 mm ² ... 2.5 mm ²
	0.2 mm ² ... 2.5 mm ² (Single ferrule)
	2x 0.5 mm ² ... 1 mm ² (TWIN ferrule)
Conductor cross section AWG	26 ... 14

Dimensions

Width	14 mm
Height	80 mm
Depth	94 mm

Material specifications

Color	gray (RAL 7042)
Flammability rating according to UL 94	V0 (Housing)

Environmental and real-life conditions

Ambient conditions

Degree of protection (Relay)	RT II (Relay)
Degree of protection (Relay base)	IP20 (Relay base)
Degree of protection (Installation location)	≥ IP54 (Installation location)
Ambient temperature (operation)	-40 °C ... 60 °C
Ambient temperature (storage/transport)	-40 °C ... 85 °C
Altitude	≤ 2000 m

Approvals

CE

Certificate	CE-compliant
-------------	--------------

UKCA

Certificate	UKCA-compliant
-------------	----------------

Shipbuilding approval

Certificate	TAE0000196
-------------	------------

Corrosive gas test

Identification	ISA-S71.04. G3 Harsh Group
	EN 60068-2-60

DNV GL data

Temperature	D
Humidity	A
Vibration	B/C
EMC	B
Enclosure	Required protection according to the Rules shall be provided upon installation on board

EMC data

PLC-RPT- 24DC/ 1ICT/ACT - Relay Module



1078683

<https://www.phoenixcontact.com/us/products/1078683>

Low Voltage Directive	Conformance with Low Voltage Directive
Electromagnetic compatibility	Conformance with EMC directive

Standards and regulations

Standards/regulations

Standards/regulations	IEC 60947-5-1
-----------------------	---------------

Mounting

Mounting type	DIN rail mounting
Assembly note	in rows with zero spacing
Mounting position	any

Drawings

Diagram

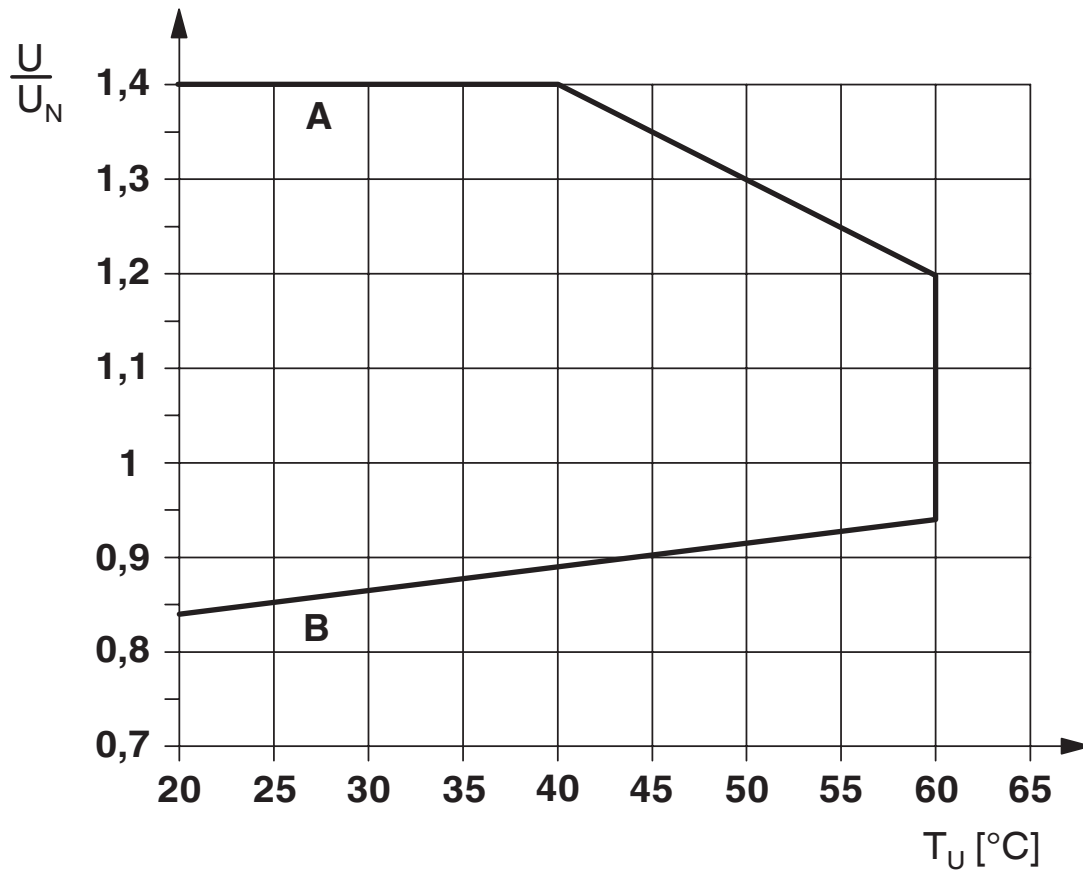

Curve A

Maximum permissible continuous voltage U_{max} with limiting continuous current on the contact side (see relevant technical data)

Curve B

Minimum permissible operate voltage U_{op} after pre-excitation (see relevant technical data)

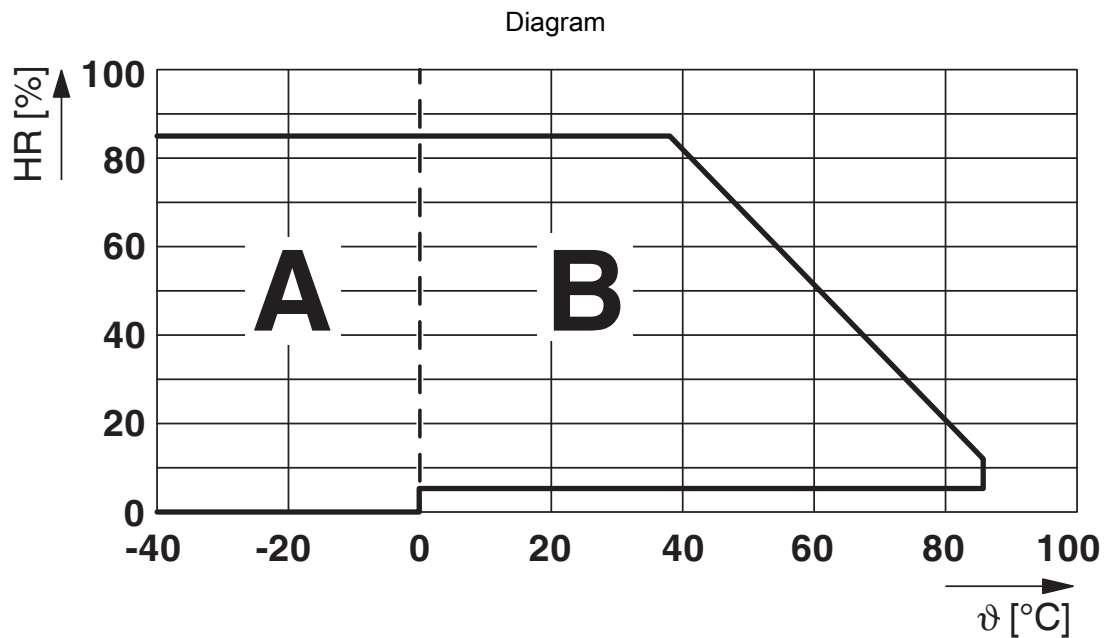

Permissible humidity for operation and storage.

The maximum permissible ambient temperature as specified in the data sheet must be observed.

Area A: Ice buildup at ambient temperatures $\leq 0^{\circ}\text{C}$ must be prevented

Area B: Condensation at ambient temperatures $> 0^{\circ}\text{C}$ must be prevented

On 30 full days that are naturally distributed across an entire year, a humidity level of 95% is permissible at an ambient temperature $\leq 25^{\circ}\text{C}$.

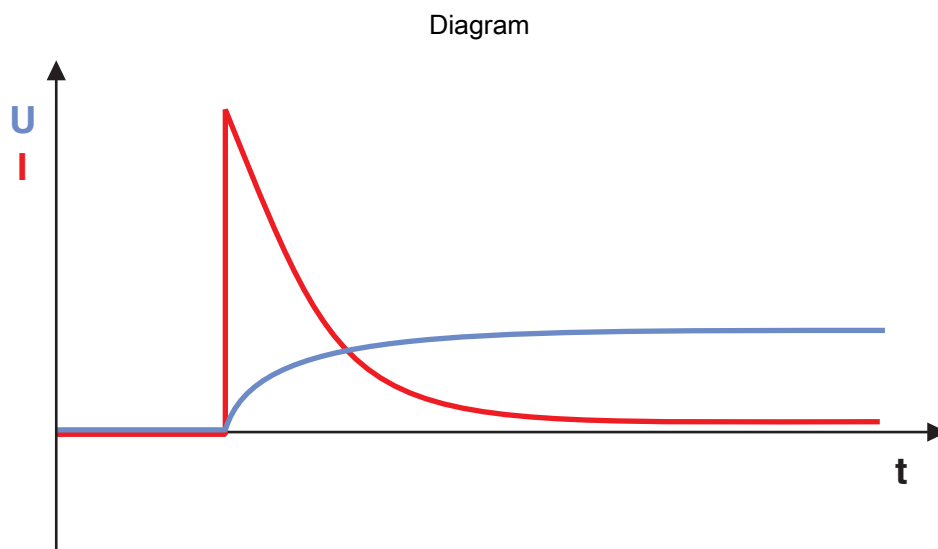

Basic behavior of capacitive loads:

- Very high inrush current
- Voltage increases with an e-function

1078683

<https://www.phoenixcontact.com/us/products/1078683>

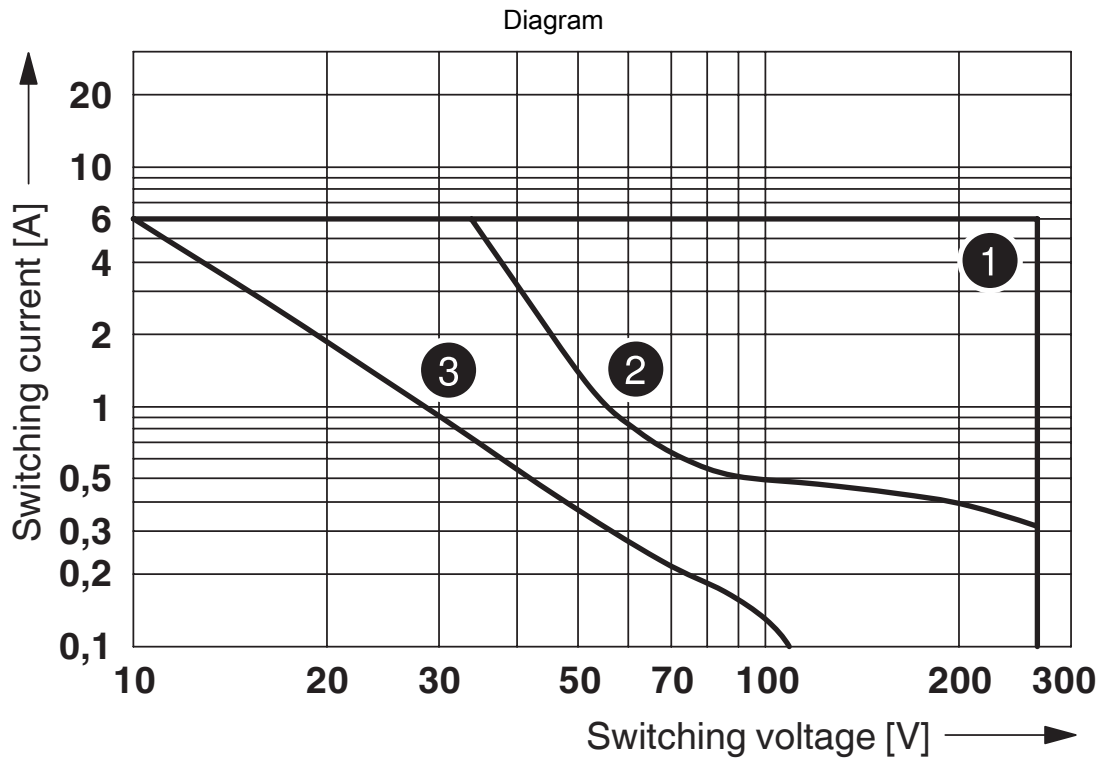

- ① AC, ohmic load
- ② DC, ohmic load
- ③ DC, L/R = 40 ms

Interrupting rating

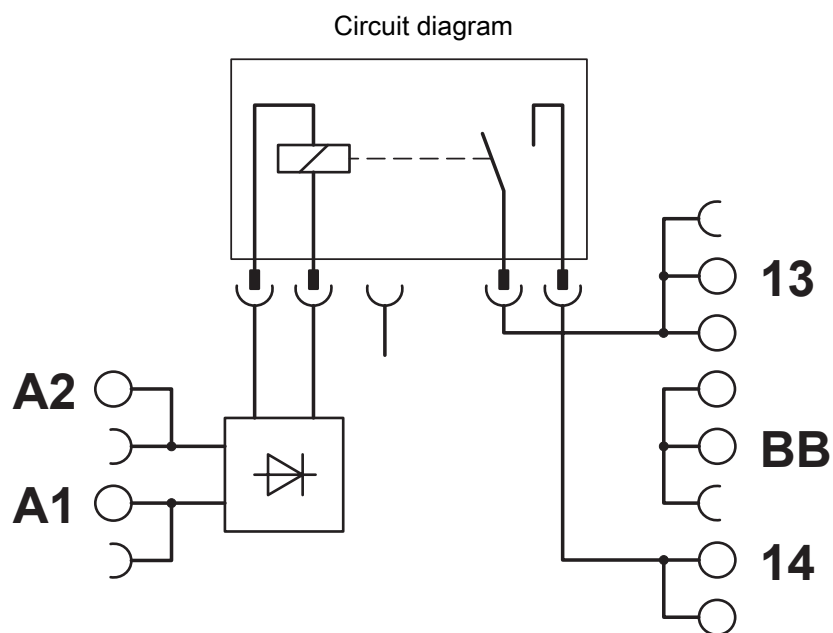

1078683

<https://www.phoenixcontact.com/us/products/1078683>

Approvals

To download certificates, visit the product detail page: <https://www.phoenixcontact.com/us/products/1078683>



cUL Recognized
Approval ID: FILE E 238705



UL Recognized
Approval ID: FILE E 238705



EAC
Approval ID: TR_TS_D_00573_c



DNV GL
Approval ID: TAE0000196



UL Listed
Approval ID: FILE E 172140



cUL Listed
Approval ID: FILE E 172140



cULus Listed
Approval ID: E140324

cULus Recognized

cULus Listed

PLC-RPT- 24DC/ 1ICT/ACT - Relay Module



1078683

<https://www.phoenixcontact.com/us/products/1078683>

Classifications

ECLASS

ECLASS-11.0	27371601
ECLASS-12.0	27371601
ECLASS-13.0	27371601

ETIM

ETIM 9.0	EC001437
----------	----------

UNSPSC

UNSPSC 21.0	39122300
-------------	----------

1078683

<https://www.phoenixcontact.com/us/products/1078683>

Environmental product compliance

EU RoHS

Fulfills EU RoHS substance requirements	Yes
Exemption	7(a), 7(c)-I

China RoHS

Environment friendly use period (EFUP)	EFUP-50
	An article-related China RoHS declaration table can be found in the download area for the respective article under "Manufacturer declaration". For all articles with EFUP-E, no China RoHS declaration table issued and required.

EU REACH SVHC

REACH candidate substance (CAS No.)	Hexahydromethylphthalic anhydride(CAS: n/a)
	Lead(CAS: 7439-92-1)
SCIP	7f145640-63ff-4b56-9f8f-50874f8c7ea2

PLC-RPT- 24DC/ 1ICT/ACT - Relay Module



1078683

<https://www.phoenixcontact.com/us/products/1078683>

Accessories

i Note: Applying some accessories below might limit this product.

FBST 500-PLC RD - Continuous plug-in bridge

2966786

<https://www.phoenixcontact.com/us/products/2966786>



Continuous plug-in bridge, length: 500 mm, color: red

i Max. current carrying capacity: 32 A

FBST 500-PLC BU - Continuous plug-in bridge

2966692

<https://www.phoenixcontact.com/us/products/2966692>

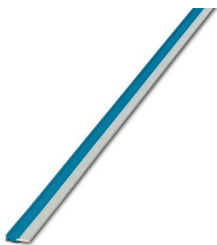

Continuous plug-in bridge, length: 500 mm, color: blue

i Max. current carrying capacity: 32 A

PLC-RPT- 24DC/ 1ICT/ACT - Relay Module

1078683

<https://www.phoenixcontact.com/us/products/1078683>



FBST 500-PLC GY - Continuous plug-in bridge

2966838

<https://www.phoenixcontact.com/us/products/2966838>



Continuous plug-in bridge, length: 500 mm, color: gray

 Max. current carrying capacity: 32 A

FBST 6-PLC RD - Single plug-in bridge

2966236

<https://www.phoenixcontact.com/us/products/2966236>

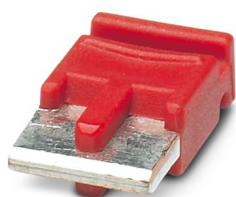

Single plug-in bridge, number of positions: 2, length: 6 mm, color: red

 Max. current carrying capacity: 6 A

PLC-RPT- 24DC/ 1ICT/ACT - Relay Module



1078683

<https://www.phoenixcontact.com/us/products/1078683>

FBST 6-PLC BU - Single plug-in bridge

2966812

<https://www.phoenixcontact.com/us/products/2966812>

Single plug-in bridge, number of positions: 2, length: 6 mm, color: blue

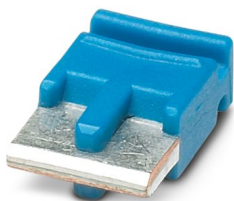

 Max. current carrying capacity: 6 A

FBST 6-PLC GY - Single plug-in bridge

2966825

<https://www.phoenixcontact.com/us/products/2966825>

Single plug-in bridge, number of positions: 2, length: 6 mm, color: gray

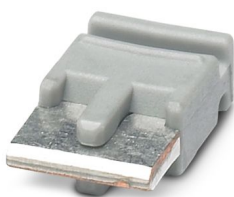

 Max. current carrying capacity: 6 A

PLC-RPT- 24DC/ 1ICT/ACT - Relay Module



1078683

<https://www.phoenixcontact.com/us/products/1078683>

FBST 8-PLC GY - Single plug-in bridge

2967688

<https://www.phoenixcontact.com/us/products/2967688>

Single plug-in bridge, number of positions: 2, length: 8 mm, color: gray



 Max. current carrying capacity: 6 A

FBST 14-PLC BK - Single plug-in bridge

2967691

<https://www.phoenixcontact.com/us/products/2967691>

Single plug-in bridge, number of positions: 2, length: 14 mm, color: black



 Max. current carrying capacity: 10 A

PLC-RPT- 24DC/ 1ICT/ACT - Relay Module



1078683

<https://www.phoenixcontact.com/us/products/1078683>

PLC-V8L/FLK14/OUT - System connection

2299660

<https://www.phoenixcontact.com/us/products/2299660>



V8 adapter for 8 x PLC-INTERFACE (14 mm), controller: PLC system cabling of output cards, connection 1: IDC/FLK pin strip 1x 14-position, connection 2: Plug-in connection (Can be snapped onto 8x PLC-INTERFACE terminals), connection 3: Screw connection 1x 2-position, number of channels: 8, control logic: positive switching

PLC-V8L/FLK14/OUT/M - System connection

2304306

<https://www.phoenixcontact.com/us/products/2304306>



V8 adapter for 8 x PLC-INTERFACE (14 mm), controller: PLC system cabling of output cards, connection 1: IDC/FLK pin strip 1x 14-position, connection 2: Plug-in connection (Can be snapped onto 8x PLC-INTERFACE terminals), connection 3: Screw connection 1x 2-position, number of channels: 8, control logic: minusschaltend

PLC-RPT- 24DC/ 1ICT/ACT - Relay Module



1078683

<https://www.phoenixcontact.com/us/products/1078683>

ZB 10:UNBEDRUCKT - Zack marker strip

1053001

<https://www.phoenixcontact.com/us/products/1053001>



Zack marker strip, Strip, white, unlabeled, can be labeled with: PLOTMARK, CMS-P1-PLOTTER, mounting type: snapped, for terminal block width: 10.2 mm, lettering field size: 10.5 x 10.15 mm, Number of individual labels: 10

ZB 10 CUS - Zack marker strip

0824941

<https://www.phoenixcontact.com/us/products/0824941>



Zack marker strip, can be ordered: Strip, white, labeled according to customer specifications, mounting type: snap into tall marker groove, for terminal block width: 10.2 mm, lettering field size: 10,15 x 10,5 mm, Number of individual labels: 10

PLC-RPT- 24DC/ 1ICT/ACT - Relay Module



1078683

<https://www.phoenixcontact.com/us/products/1078683>

ZB10,LGS:FORTL.ZAHLEN - Zack marker strip

1053014

<https://www.phoenixcontact.com/us/products/1053014>



Zack marker strip, Strip, white, labeled, can be labeled with: CMS-P1-PLOTTER, printed horizontally: consecutive numbers 1 ... 10, 11 ... 20, etc. up to 91 ... 100, mounting type: snapped, for terminal block width: 10.2 mm, lettering field size: 10,15 x 10,5 mm, Number of individual labels: 10

ZB10,QR:FORTL.ZAHLEN - Zack marker strip

1053027

<https://www.phoenixcontact.com/us/products/1053027>



Zack marker strip, Strip, white, labeled, can be labeled with: CMS-P1-PLOTTER, Printed vertically: consecutive numbers 1 ... 10, 11 ... 20, etc. up to 91 ... 100, mounting type: snapped, for terminal block width: 10.2 mm, lettering field size: 10,15 x 10,5 mm, Number of individual labels: 10

PLC-RPT- 24DC/ 1ICT/ACT - Relay Module



1078683

<https://www.phoenixcontact.com/us/products/1078683>

ZB10,LGS:L1-N,PE - Marker for terminal blocks

1053412

<https://www.phoenixcontact.com/us/products/1053412>



Marker for terminal blocks, Strip, white, labeled, can be labeled with: CMS-P1-PLOTTER, horizontal: L1, L2, L3, N, PE, L1, L2, L3, N, PE, mounting type: snapped, for terminal block width: 10.2 mm, lettering field size: 10,15 x 10,5 mm, Number of individual labels: 10

ZB10,LGS:U-N - Marker for terminal blocks

1053438

<https://www.phoenixcontact.com/us/products/1053438>



Marker for terminal blocks, Strip, white, labeled, can be labeled with: CMS-P1-PLOTTER, horizontal: U, V, W, N, GND, U, V, W, N, GND, mounting type: snapped, for terminal block width: 10.2 mm, lettering field size: 10,15 x 10,5 mm, Number of individual labels: 10

PLC-RPT- 24DC/ 1ICT/ACT - Relay Module



1078683

<https://www.phoenixcontact.com/us/products/1078683>

UC-TM 10 - Marker for terminal blocks

0818069

<https://www.phoenixcontact.com/us/products/0818069>



Marker for terminal blocks, Sheet, white, unlabeled, can be labeled with: BLUEMARK ID COLOR, BLUEMARK ID, BLUEMARK CLED, PLOTMARK, CMS-P1-PLOTTER, mounting type: snapped, for terminal block width: 10.2 mm, lettering field size: 9.6 x 10.5 mm, Number of individual labels: 48

UC-TM 10 CUS - Marker for terminal blocks

0824605

<https://www.phoenixcontact.com/us/products/0824605>



Marker for terminal blocks, can be ordered: by sheet, white, labeled according to customer specifications, mounting type: snap into tall marker groove, for terminal block width: 10.2 mm, lettering field size: 9.6 x 10.5 mm, Number of individual labels: 48

PLC-RPT- 24DC/ 1ICT/ACT - Relay Module



1078683

<https://www.phoenixcontact.com/us/products/1078683>

UCT-TM 10 - Marker for terminal blocks

0829142

<https://www.phoenixcontact.com/us/products/0829142>



Marker for terminal blocks, Sheet, white, unlabeled, can be labeled with: TOPMARK NEO, TOPMARK LASER, BLUEMARK ID COLOR, BLUEMARK ID, BLUEMARK CLED, THERMOMARK PRIME, THERMOMARK CARD 2.0, THERMOMARK CARD, mounting type: snapped, for terminal block width: 10.2 mm, lettering field size: 8.9 x 9.6 mm, Number of individual labels: 36

UCT-TM 10 CUS - Marker for terminal blocks

0829623

<https://www.phoenixcontact.com/us/products/0829623>



Marker for terminal blocks, can be ordered: by sheet, white, labeled according to customer specifications, mounting type: snap into tall marker groove, for terminal block width: 10.2 mm, lettering field size: 8.9 x 9.6 mm, Number of individual labels: 36

PLC-RPT- 24DC/ 1ICT/ACT - Relay Module



1078683

<https://www.phoenixcontact.com/us/products/1078683>

ZB 12:UNPRINTED - Zack marker strip

0812120

<https://www.phoenixcontact.com/us/products/0812120>



Zack marker strip, Strip, white, unlabeled, can be labeled with: PLOTMARK, CMS-P1-PLOTTER, mounting type: snapped, for terminal block width: 12.2 mm, lettering field size: 12 x 10.5 mm, Number of individual labels: 5

ZB 12 CUS - Zack marker strip

0824942

<https://www.phoenixcontact.com/us/products/0824942>

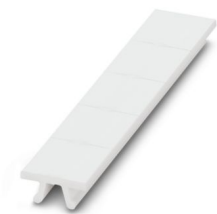

Zack marker strip, can be ordered: Strip, white, labeled according to customer specifications, mounting type: snap into tall marker groove, for terminal block width: 12.2 mm, lettering field size: 10.5 x 12.15 mm, Number of individual labels: 5

PLC-RPT- 24DC/ 1ICT/ACT - Relay Module



1078683

<https://www.phoenixcontact.com/us/products/1078683>

ZB 12,LGS:L1-N,PE - Zack marker strip

0812146

<https://www.phoenixcontact.com/us/products/0812146>

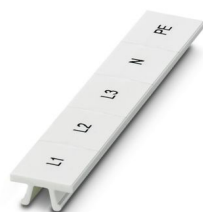

Zack marker strip, Strip, white, labeled, printed horizontally: L1, L2, L3, N, PE, mounting type: snapped, for terminal block width: 12.2 mm, lettering field size: 10.5 x 12.15 mm, Number of individual labels: 5

UC-TM 12 - Marker for terminal blocks

0819194

<https://www.phoenixcontact.com/us/products/0819194>



Marker for terminal blocks, Sheet, white, unlabeled, can be labeled with: BLUEMARK ID COLOR, BLUEMARK ID, BLUEMARK CLED, PLOTMARK, CMS-P1-PLOTTER, mounting type: snapped, for terminal block width: 12 mm, lettering field size: 11.45 x 10.5 mm, Number of individual labels: 40

PLC-RPT- 24DC/ 1ICT/ACT - Relay Module



1078683

<https://www.phoenixcontact.com/us/products/1078683>

UC-TM 12 CUS - Marker for terminal blocks

0824613

<https://www.phoenixcontact.com/us/products/0824613>



Marker for terminal blocks, can be ordered: by sheet, white, labeled according to customer specifications, mounting type: snap into tall marker groove, for terminal block width: 12 mm, lettering field size: 11.45 x 10.5 mm, Number of individual labels: 40

UCT-TM 12 - Marker for terminal blocks

0829144

<https://www.phoenixcontact.com/us/products/0829144>



Marker for terminal blocks, Sheet, white, unlabeled, can be labeled with: TOPMARK NEO, TOPMARK LASER, BLUEMARK ID COLOR, BLUEMARK ID, BLUEMARK CLED, THERMOMARK PRIME, THERMOMARK CARD 2.0, THERMOMARK CARD, mounting type: snapped, for terminal block width: 12 mm, lettering field size: 10.8 x 9.6 mm, Number of individual labels: 30

PLC-RPT- 24DC/ 1ICT/ACT - Relay Module



1078683

<https://www.phoenixcontact.com/us/products/1078683>

UCT-TM 12 CUS - Marker for terminal blocks

0829630

<https://www.phoenixcontact.com/us/products/0829630>



Marker for terminal blocks, can be ordered: by sheet, white, labeled according to customer specifications, mounting type: snap into tall marker groove, for terminal block width: 12 mm, lettering field size: 10.8 x 9.6 mm, Number of individual labels: 30

NS 35/ 7,5 PERF 2000MM - DIN rail perforated

0801733

<https://www.phoenixcontact.com/us/products/0801733>



DIN rail perforated, Pack of 25 (50 m), acc. to EN 60715, material: Steel, galvanized, passivated with a thick layer, Standard profile, color: silver

PLC-RPT- 24DC/ 1ICT/ACT - Relay Module



1078683

<https://www.phoenixcontact.com/us/products/1078683>

NS 35/ 7,5 UNPERF 2000MM - DIN rail, unperforated

0801681

<https://www.phoenixcontact.com/us/products/0801681>



DIN rail, unperforated, Pack of 25 (50 m), acc. to EN 60715, material: Steel, galvanized, passivated with a thick layer, Standard profile, color: silver

NS 35/ 7,5 WH PERF 2000MM - DIN rail perforated

1204119

<https://www.phoenixcontact.com/us/products/1204119>



DIN rail perforated, Pack of 25 (50 m), acc. to EN 60715, material: Steel, Galvanized, white passivated, Standard profile, color: silver

PLC-RPT- 24DC/ 1ICT/ACT - Relay Module



1078683

<https://www.phoenixcontact.com/us/products/1078683>

NS 35/ 7,5 WH UNPERF 2000MM-VPE 10 - DIN rail, unperforated

1204122

<https://www.phoenixcontact.com/us/products/1204122>



DIN rail, unperforated, Pack of 10 (20 m), acc. to EN 60715, material: Steel, Galvanized, white passivated, Standard profile, color: silver

NS 35/ 7,5 AL UNPERF 2000MM - DIN rail, unperforated

0801704

<https://www.phoenixcontact.com/us/products/0801704>



DIN rail, unperforated, Pack of 25 (50 m), acc. to EN 60715, material: Aluminum, uncoated, Standard profile, color: silver

PLC-RPT- 24DC/ 1ICT/ACT - Relay Module



1078683

<https://www.phoenixcontact.com/us/products/1078683>

NS 35/ 7,5 ZN PERF 2000MM - DIN rail perforated

1206421

<https://www.phoenixcontact.com/us/products/1206421>



DIN rail perforated, Pack of 25 (50 m), acc. to EN 60715, material: Steel, galvanized, Standard profile, color: silver

NS 35/ 7,5 ZN UNPERF 2000MM - DIN rail, unperforated

1206434

<https://www.phoenixcontact.com/us/products/1206434>



DIN rail, unperforated, Pack of 25 (50 m), acc. to EN 60715, material: Steel, galvanized, Standard profile, color: silver

PLC-RPT- 24DC/ 1ICT/ACT - Relay Module



1078683

<https://www.phoenixcontact.com/us/products/1078683>

NS 35/ 7,5 CU UNPERF 2000MM-VPE 10 - DIN rail, unperforated

0801762

<https://www.phoenixcontact.com/us/products/0801762>



DIN rail, unperforated, Pack of 10 (20 m), acc. to EN 60715, material: Copper, uncoated, Standard profile, color: copper-colored

NS 35/ 7,5 CAP - End cap

1206560

<https://www.phoenixcontact.com/us/products/1206560>

DIN rail end piece, for DIN rail NS 35/7.5



PLC-RPT- 24DC/ 1ICT/ACT - Relay Module



1078683

<https://www.phoenixcontact.com/us/products/1078683>

NS 35/15 PERF 2000MM - DIN rail perforated

1201730

<https://www.phoenixcontact.com/us/products/1201730>



DIN rail perforated, Pack of 25 (50 m), similar to EN 60715, material: Steel, galvanized, passivated with a thick layer, Standard profile, color: silver

NS 35/15 UNPERF 2000MM - DIN rail, unperforated

1201714

<https://www.phoenixcontact.com/us/products/1201714>



DIN rail, unperforated, Pack of 25 (50 m), similar to EN 60715, material: Steel, galvanized, passivated with a thick layer, Standard profile, color: silver

PLC-RPT- 24DC/ 1ICT/ACT - Relay Module



1078683

<https://www.phoenixcontact.com/us/products/1078683>

NS 35/15 WH PERF 2000MM - DIN rail perforated

0806602

<https://www.phoenixcontact.com/us/products/0806602>



DIN rail perforated, Pack of 25 (50 m), similar to EN 60715, material: Steel, Galvanized, white passivated, Standard profile, color: white

NS 35/15 WH UNPERF 2000MM-VPE 10 - DIN rail, unperforated

1204135

<https://www.phoenixcontact.com/us/products/1204135>



DIN rail, unperforated, Pack of 10 (20 m), similar to EN 60715, material: Steel, Galvanized, white passivated, Standard profile, color: silver

PLC-RPT- 24DC/ 1ICT/ACT - Relay Module



1078683

<https://www.phoenixcontact.com/us/products/1078683>

NS 35/15 AL UNPERF 2000MM - DIN rail, unperforated

1201756

<https://www.phoenixcontact.com/us/products/1201756>



DIN rail, unperforated, similar to EN 60715, material: Aluminum, uncoated, Standard profile, color: silver

NS 35/15 ZN PERF 2000MM - DIN rail perforated

1206599

<https://www.phoenixcontact.com/us/products/1206599>



DIN rail perforated, Pack of 25 (50 m), similar to EN 60715, material: Steel, galvanized, Standard profile, color: silver

PLC-RPT- 24DC/ 1ICT/ACT - Relay Module



1078683

<https://www.phoenixcontact.com/us/products/1078683>

NS 35/15 ZN UNPERF 2000MM - DIN rail, unperforated

1206586

<https://www.phoenixcontact.com/us/products/1206586>



DIN rail, unperforated, Pack of 25 (50 m), similar to EN 60715, material: Steel, galvanized, Standard profile, color: silver

NS 35/15 CU UNPERF 2000MM-VPE 10 - DIN rail, unperforated

1201895

<https://www.phoenixcontact.com/us/products/1201895>



DIN rail, unperforated, Pack of 10 (20 m), similar to EN 60715, material: Copper, uncoated, Standard profile, color: copper-colored

PLC-RPT- 24DC/ 1ICT/ACT - Relay Module



1078683

<https://www.phoenixcontact.com/us/products/1078683>

NS 35/15 CAP - End cap

1206573

<https://www.phoenixcontact.com/us/products/1206573>

DIN rail end piece, for DIN rail NS 35/15



NS 35/15-2,3 UNPERF 2000MM-VPE 10 - DIN rail, unperforated

1201798

<https://www.phoenixcontact.com/us/products/1201798>

DIN rail, unperforated, Pack of 10 (20 m), acc. to EN 60715, material: Steel, galvanized, passivated with a thick layer, Standard profile 2.3 mm, color: silver



PLC-RPT- 24DC/ 1ICT/ACT - Relay Module



1078683

<https://www.phoenixcontact.com/us/products/1078683>

PLC-ATP BK - Separating plate

2966841

<https://www.phoenixcontact.com/us/products/2966841>



Separating plate, 2 mm thick, required at the start and end of a PLC terminal strip. Furthermore, it is used for: visual separation of groups, safe isolation of different voltages of neighboring PLC relays in acc. with DIN VDE 0106-101, isolation

PLC-ESK GY - Power terminal block

2966508

<https://www.phoenixcontact.com/us/products/2966508>



Power terminal block, for the input of up to four potentials, for mounting on NS 35/7.5

PLC-RPT- 24DC/ 1ICT/ACT - Relay Module



1078683

<https://www.phoenixcontact.com/us/products/1078683>

SZF 1-0,6X3,5 - Screwdriver

1204517

<https://www.phoenixcontact.com/us/products/1204517>



Actuation tool, for ST terminal blocks, also suitable for use as a bladed screwdriver, size: 0.6 x 3.5 x 100 mm, 2-component grip, with non-slip grip

REL-MR- 24DC/ 1ICT - Single relay

2987338

<https://www.phoenixcontact.com/us/products/2987338>



Pluggable miniature power relay, with tungsten pre-contact for high switch-on currents up to 800 A peaks, 1 N/O contact, input voltage: 24 V DC

Phoenix Contact 2024 © - all rights reserved
<https://www.phoenixcontact.com>

Phoenix Contact USA
586 Fulling Mill Road
Middletown, PA 17057, United States
(+717) 944-1300
info@phoenixcon.com