

# G5RL-U/-K

PCB Power Relay

## Small-Size and Low-Back High Performance Latching Relay that Realizes a 16-A High Inrush Switching Current

- Creepage distance 8 mm between coil and contacts
- 10 kV impulse withstand voltage
- Ambient operating temperature 85°C
- Suitable for TV-8 rating (G5RL-□1A-E)
- In-rush resistant and supports illumination load
- Compatible with capacitor load (IEC60669-1) (G5RL-□1A-EL-HA)
- Compatible with the International Safety Standard for Electrical/Electronic Household Appliances (IEC60335-1) (G5RL-□1A-EL-HA)



Note. The actual product is marked differently from the image shown above.

### Model Number Legend

G5RL- $\frac{\square}{1}\frac{\square}{2}\frac{\square}{3}\frac{\square}{4}\frac{\square}{5}$

#### 1. Relay Function

U : Single-winding latching  
K : Double-winding latching

#### 2. Number of poles

1 : 1-Pole

#### 3. Contact Form

None: SPDT (1c)  
A : SPST-NO (1a)

#### 4. Classification

E : High-capacity  
EL: In-rush resistance  
(Compatible with IEC60669-1)

#### 5. Market Code

None: General purpose  
HA: Home Appliance according to IEC/EN60335-1

### Application Examples

- Housing equipment
- Building automation
- UPS, FA equipment
- Electric power meter
- Illumination control
- Smart home

G5RL-U/-K

### Ordering Information

Classification	Terminal shape	Contact form	Enclosure rating	Single-winding latching		Double-winding latching		Minimum packing unit
				Model	Rated coil voltage	Model	Rated coil voltage	
High-capacity	PCB terminals	SPST-NO (1a)	Flux protection	<b>G5RL-U1A-E</b>	3 VDC 5 VDC 6 VDC	<b>G5RL-K1A-E</b>	5 VDC 12 VDC 24 VDC	100 pcs/tray
		SPDT (1c)		<b>G5RL-U1-E</b>	12 VDC 24 VDC	<b>G5RL-K1-E</b>		
In-rush resistance		SPST-NO (1a)		<b>G5RL-U1A-EL-HA</b>	5 VDC 12 VDC 24 VDC	<b>G5RL-K1A-EL-HA</b>		

Note. When ordering, add the rated coil voltage to the model number.

Example: G5RL-U1A-E DC5

Rated coil voltage

However, the notation of the coil voltage on the product case as well as on the packing will be marked as □□ VDC.

## ■ Ratings

### ● Coil

#### Single-Winding Latching Type

Rated voltage	Rated current (mA)	Coil resistance (Ω)	Must set voltage	Must reset voltage	Max voltage	Power consumption (W)
			% of rated voltage			
3 VDC	200	15	70% max.	70% max.	130%	Approx. 0.6
5 VDC	120	41.7				
6 VDC	100	60				
12 VDC	50	240				
24 VDC	25	960				

#### Double-Winding Latching Type

Rated voltage	Rated current (mA)		Coil resistance (Ω)		Must set voltage	Must reset voltage	Max voltage	Power consumption (W)	
	Set coil	Reset coil	Set coil	Reset coil	% of rated voltage			Set coil	Reset coil
5 VDC	150		33.3		70% max.	70% max.	130%	Approx. 0.75	
12 VDC	62.5		192						
24 VDC	35		686					Approx. 0.84	

Note. The rated current and resistance are measured at a coil temperature of 23°C with a tolerance of ±10%.

### ● Contacts

Load	Resistive load		
	High-capacity		In-rush resistance
Classification	SPST-NO (1a)		SPST-NO (1a)
Contact form	SPST-NO (1a)		SPDT (1c)
Contact type	Single		
Contact material	Ag Alloy (Cd free)		
Rated load	16 A at 250 VAC 16 A at 24 VDC		16 A at 250 VAC (NO) 5 A at 250 VAC (NC) 16 A at 24 VDC (NO) 5 A at 24 VDC (NC)
Rated carry current	16 A		16 A (NO), 5 A (NC)
Max. switching voltage	250 VAC, 24 VDC		250 VAC
Max. switching current	16 A		16 A (NO), 5 A (NC)

## ■ Characteristics

Item	Classification Relay function Contact form	High-capacity	In-rush resistance
		Single-winding latching, Double-winding latching	
		SPST-NO (1a), SPDT (1c)	
Contact resistance *1		100 mΩ max.	
Set time		10 ms max.	
Reset time		10 ms max.	
Minimum pulse width *2		30 ms	
Maximum pulse width *2		1 min	
Insulation resistance *3		1,000 MΩ min.	
Dielectric strength	Between coil and contacts	6,000 VAC, 50/60 Hz for 1 min	
	Between contacts of the same polarity	1,000 VAC, 50/60 Hz for 1 min	1,250 VAC, 50/60 Hz for 1 min
Impulse withstand voltage	Between coil and contacts	10 kV (1.2 × 50 μs)	
Insulation distance	Between coil and contacts	Clearance: 6.4 mm, Creepage: 8 mm	
Vibration resistance	Destruction	10 to 55 to 10 Hz, 0.75 mm single amplitude (1.5 mm double amplitude)	
	Malfunction	10 to 55 to 10 Hz, 0.75 mm single amplitude (1.5 mm double amplitude) at set status 10 to 55 to 10 Hz, 0.75 mm single amplitude (1.5 mm double amplitude) at reset status (Except SPST-NO)	
Shock resistance	Destruction	1,000 m/s <sup>2</sup>	
	Malfunction	150 m/s <sup>2</sup> at Set status 50 m/s <sup>2</sup> at Reset status (Except SPST-NO)	
Durability	Mechanical *4	5,000,000 operations min.	
	Electrical *4	50,000 operations min.	20,000 operations min.
Ambient operating temperature		-40° to 85°C (with no icing or condensation)	
Ambient operating humidity		5% to 85%	
Weight		Approx. 10 g	

Note. Values in the above table are initial values.

\*1. The contact resistance is measured with 1 A applied at 5 VDC using a fall-of-potential method.

\*2. These are measured at a coil temperature of 23°C and rated coil voltage.  
Pulse duty factor should be 10% MAX.

\*3. The insulation resistance is measured between coil and contacts and between contacts of same polarity at 500 VDC.

\*4. Operated with input pulse width "30 ms".

## Engineering Data

### In-Rush Resistant Performance (IEC60669-1 Certified Switching Frequency)

#### G5RL-U1A-EL-HA

Contact form	Operation coil rating	Contact ratings	Number of test cycles
SPST-NO (1a)	5, 12, 24 VDC	IEC60669-1 16A 250VAC Capacitor 140 $\mu$ F room temperature	20,000

#### G5RL-K1A-EL-HA

Contact form	Operation coil rating	Contact ratings	Number of test cycles
SPST-NO (1a)	5, 12, 24 VDC	IEC60669-1 16A 250VAC Capacitor 140 $\mu$ F room temperature	20,000

### Maximum Switching Power High-Capacity

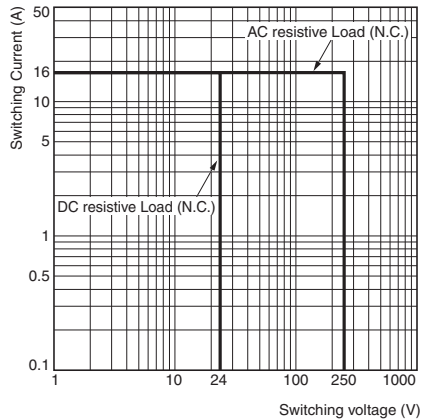

### In-Rush Resistance

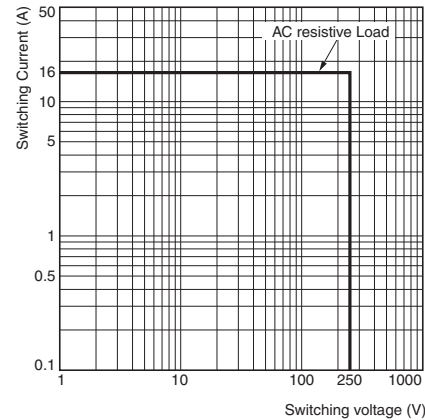

### Ambient Temperature vs. Maximum Coil Voltage

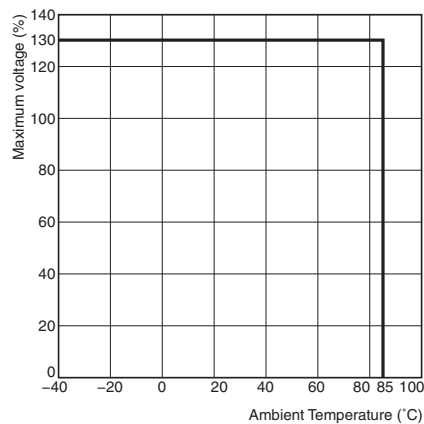

Note. Maximum voltage of set pulse and reset pulse at duty factor 10% (Maximum pulse width: 1min).

### Malfunction Shock

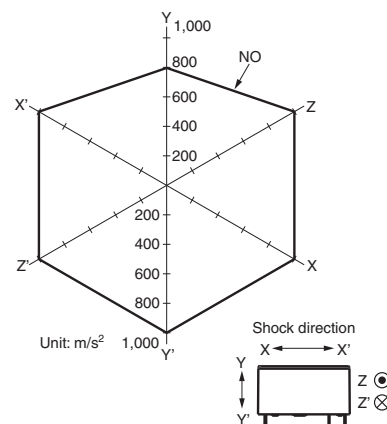

Sample: G5RL-K1A-E 12VDC  
 No. of relays: 5 pcs  
 Test conditions: Shock is applied in  $\pm X$ ,  $\pm Y$ , and  $\pm Z$  directions three times each with set and reset status to check the number of contact malfunctions.  
 Standard value: 50  $m/s^2$  with set status  
 100  $m/s^2$  with reset status

## ■Dimensions

(Unit: mm)

### G5RL-U1A-E

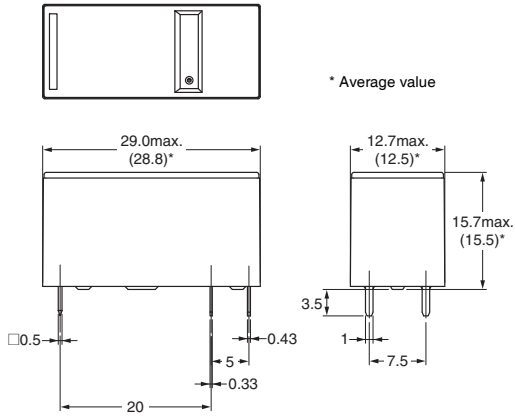
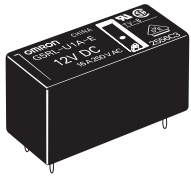

#### PCB Mounting Holes (BOTTOM VIEW)

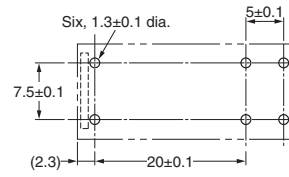

#### Terminal Arrangement/ Internal Connections (BOTTOM VIEW)

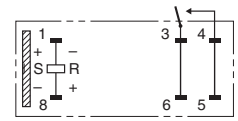

Note. Check carefully the coil polarity of the relay.

Note. Orientation marks are indicated as follows: □ ▨

### G5RL-U1-E

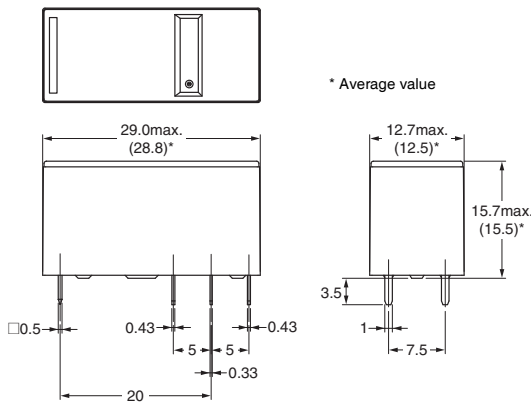
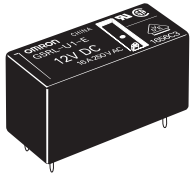

#### PCB Mounting Holes (BOTTOM VIEW)

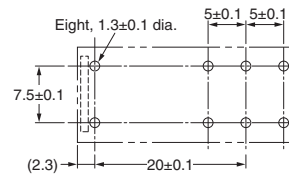

#### Terminal Arrangement/ Internal Connections (BOTTOM VIEW)

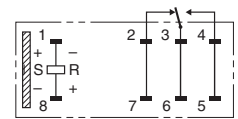

Note. Check carefully the coil polarity of the relay.

Note. Orientation marks are indicated as follows: □ ▨

### G5RL-K1A-E

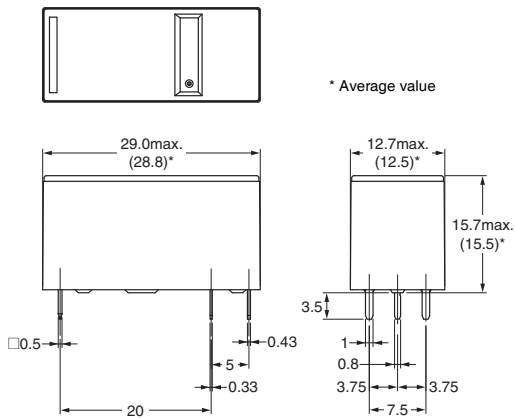
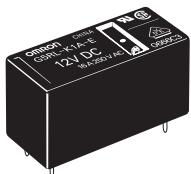

#### PCB Mounting Holes (BOTTOM VIEW)

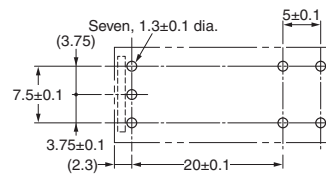

#### Terminal Arrangement/ Internal Connections (BOTTOM VIEW)

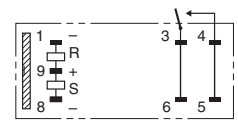

Note. Check carefully the coil polarity of the relay.

Note. Orientation marks are indicated as follows: □ ▨

### G5RL-K1-E

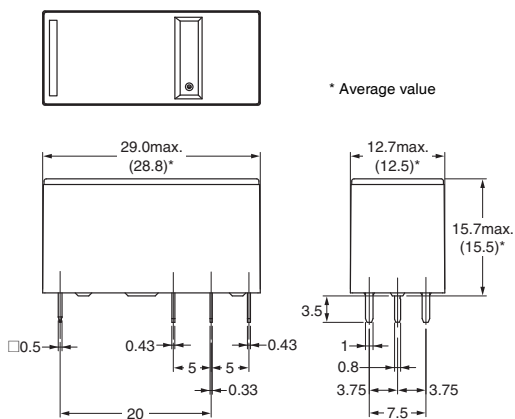
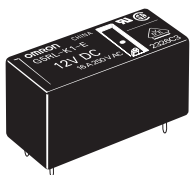

#### PCB Mounting Holes (BOTTOM VIEW)

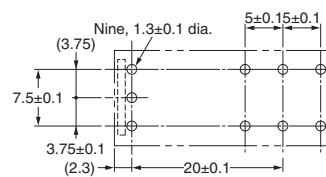

#### Terminal Arrangement/ Internal Connections (BOTTOM VIEW)

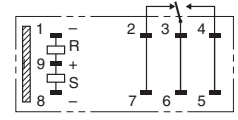

Note. Check carefully the coil polarity of the relay.

Note. Orientation marks are indicated as follows: □ ▨

## G5RL-U1A-EL-HA

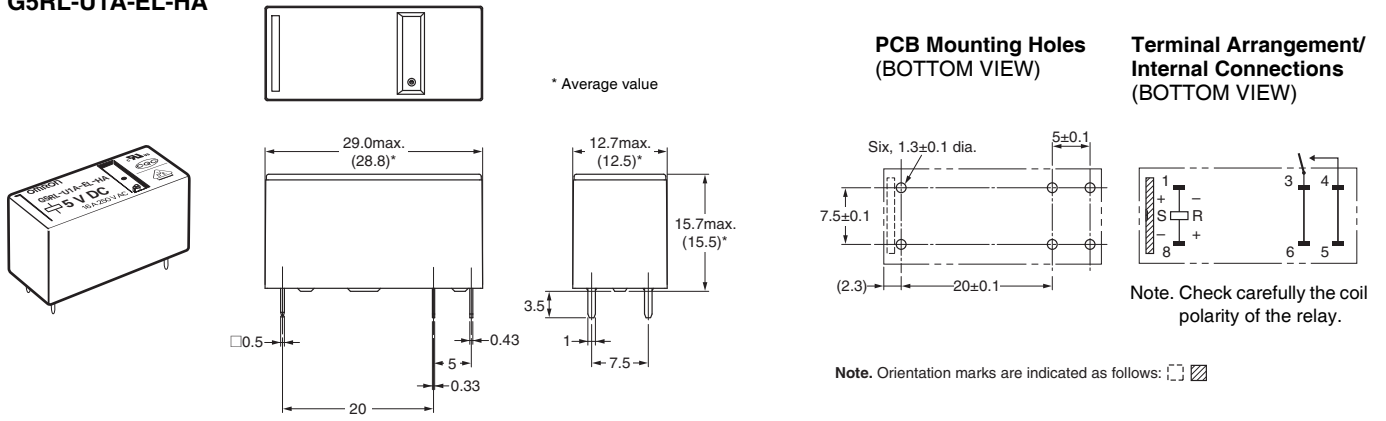

## G5RL-K1A-EL-HA

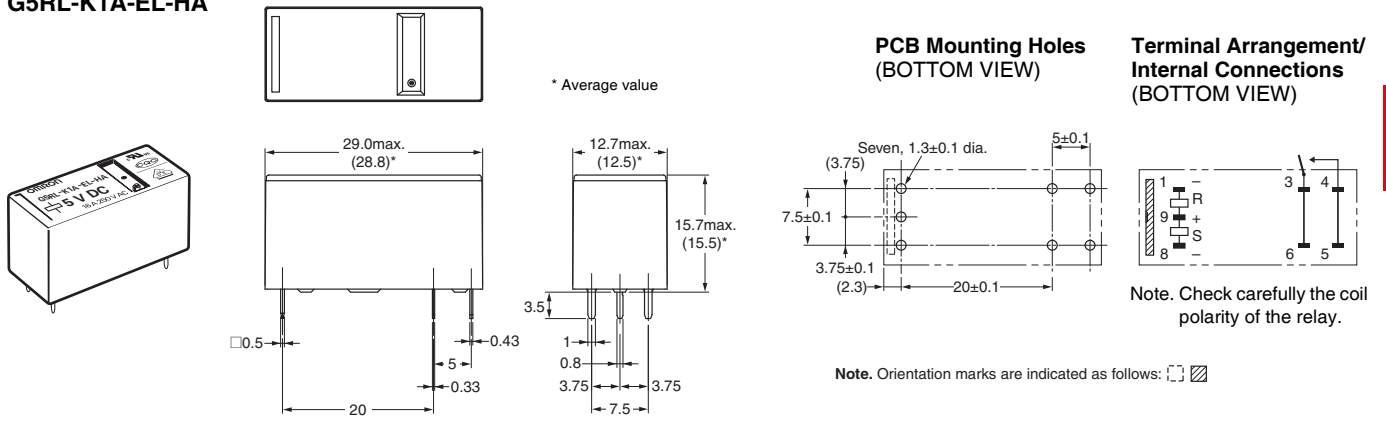

G5RL-U/-K

## ■ Approved Standards

### ● UL Recognized (File No. E41643) and CSA Certified (File No. LR31928)

Model	Contact form	Coil ratings	Contact ratings	Number of test cycles
G5RL-U1A-E G5RL-K1A-E	SPST-NO (1a)	Single-winding latching: 3, 5, 6, 12, 24 VDC Double-winding latching: 5, 12, 24 VDC	16 A 277 VAC (Resistive) - NO 85°C	50,000
			TV-5 - NO 40°C	25,000
			TV-8 - NO 40°C	25,000
			8 A 250 VAC (Ballast) - NO 40°C	6,000
			2,000 W 250 VAC (Tungsten) 70°C	6,000
G5RL-U1-E G5RL-K1-E	SPDT (1c)	Single-winding latching: 3, 5, 6, 12, 24 VDC Double-winding latching: 5, 12, 24 VDC	16 A 277 VAC (Resistive) - NO 85°C	50,000
			8 A 250 VAC (Ballast) - NO 40°C	6,000
			2,000 W 250 VAC (Tungsten) - NO 40°C	6,000
			5 A 250 VAC (General) - NC 40°C	50,000

### ● UL/C-UL-approved models (File No. E41643)

Model	Contact form	Coil ratings	Contact ratings	Number of test cycles
G5RL-U1A-EL-HA G5RL-K1A-EL-HA	SPST-NO (1a)	Single-winding latching: 5, 12, 24 VDC Double-winding latching: 5, 12, 24 VDC	16 A 250 VAC (General) 85°C	6,000

### ● VDE Certified (EN61810-1) (License No. 40007172)

Model	Contact form	Coil ratings	Contact ratings	Number of test cycles
G5RL-U1A-E G5RL-K1A-E	SPST-NO (1a)	Single-winding latching: 3, 5, 6, 12, 24 VDC Double-winding latching: 5, 12, 24 VDC	16 A 250 VAC (cosφ=1) - NO 85°C	30,000
			240 VAC 100 A (0-P) Steady 10 A (rms) - NO 85°C	50,000
G5RL-U1-E G5RL-K1-E	SPDT (1c)	Single-winding latching: 3, 5, 6, 12, 24 VDC Double-winding latching: 5, 12, 24 VDC	16 A 250 VAC (cosφ=1) - NO 85°C	30,000
			5 A 250 VAC (cosφ=1) - NC 85°C	30,000
G5RL-U1A-EL-HA G5RL-K1A-EL-HA	SPST-NO (1a)	Single-winding latching: 5, 12, 24 VDC Double-winding latching: 5, 12, 24 VDC	16 A 250 VAC (cosφ=1) 85°C	6,000
			IEC60669-1: 16 A 250 VAC Capacitor 140 μF room temperature	20,000

### ● CQC Certified (File No. CQC21002283993)

Model	Contact form	Coil ratings	Contact ratings	Number of test cycles
G5RL-U1A-EL-HA G5RL-K1A-EL-HA	SPST-NO (1a)	Single-winding latching: 5, 12, 24 VDC Double-winding latching: 5, 12, 24 VDC	16 A 250 VAC (cosφ=1) 85°C	6,000

## ■Precautions

●Please refer to “PCB Relays Common Precautions” for correct use.

### Correct Use

#### ●Basic Operation of Latching Relays

- In these relays, the input pulse of the set coil causes the operating condition to be maintained magnetically or mechanically, whereas the input pulse to the reset coil side puts the relay into the reset condition.

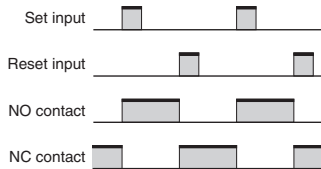

#### ●Coil Temperature Rise of Long Time Continuous Current to the Coil

- When the coil is applied continuous current for a long time, the coil would be heated too much. Please decide the coil input pulse width by “heat and cold of coil temperature.”

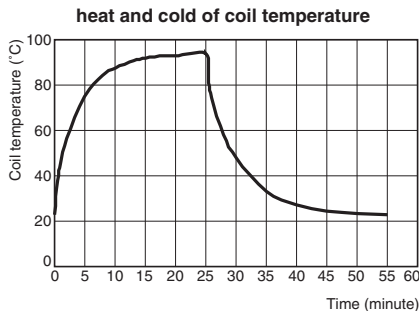

#### ●Wiring of High-Capacity Models (-E) and In-Rush Resistance Models (-EL)

- High-capacity models (-E) and In-rush resistance models (-EL) have a structure that connects two terminals from one contact. When designing the circuit, use both terminals. If you use only one terminal, the relay may be unable to satisfy specified performance.

#### ●Precautions for Correct Use

- This product is not suitable for vehicles such as automobiles (including two-wheeled vehicles).
- If the product is used in the following applications, consult your OMRON sales representative to check the necessary items according to the specification sheets. Also, make sure the product is used within the specified ratings and performance ranges with an ample margin and implement safety measures, such as designing a safety circuit, to minimize danger should the product fail.
  - Outdoor use, uses involving potential chemical contamination or electrical interference.
  - Nuclear energy control systems, combustion systems, railroad systems, aviation systems, medical equipment, safety equipment, and equipment that could present a risk to human life or body.
  - Equipment requiring a high level of reliability, such as gas, water, or electrical supply systems.

G5RL-U/-K

Please check each region's Terms & Conditions by region website.

## OMRON Corporation Device & Module Solutions Company

### Regional Contact

#### Americas

<https://components.omron.com/us>

#### Asia-Pacific

<https://components.omron.com/ap>

#### Korea

<https://components.omron.com/kr>

#### Europe

<https://components.omron.com/eu>

#### China

<https://components.omron.com/cn>

#### Japan

<https://components.omron.com/jp>