

APPROVED: \_\_\_\_\_  
 DATE: \_\_\_\_\_ TITLE: \_\_\_\_\_

Rev	AWO #	Description	Date	Appr
-		RELEASED	12/6/21	
A		ADDED DRAWING	5/27/22	WX/RC

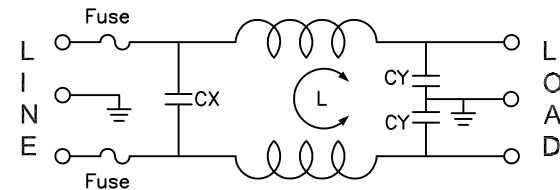

L:2x0.3mH  
 Cx:0.1uF(X2)  
 Cy:3300pF(Y2)\*2

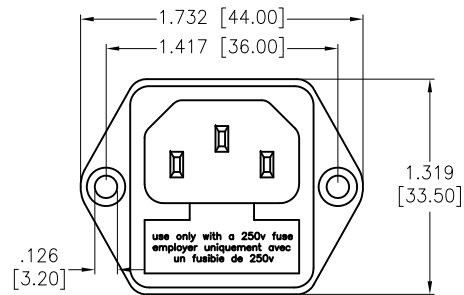
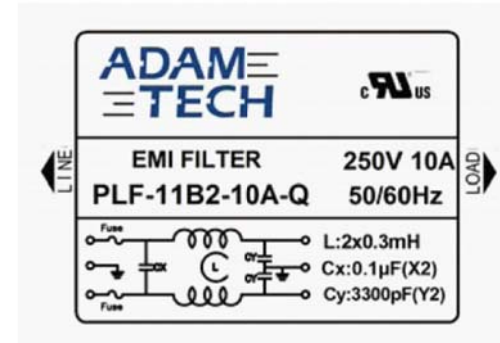
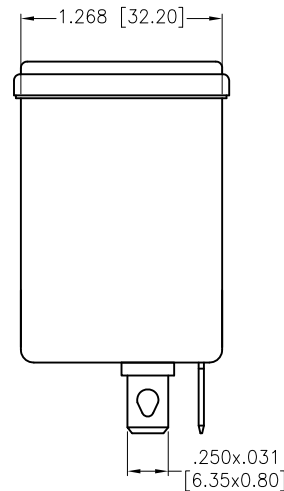
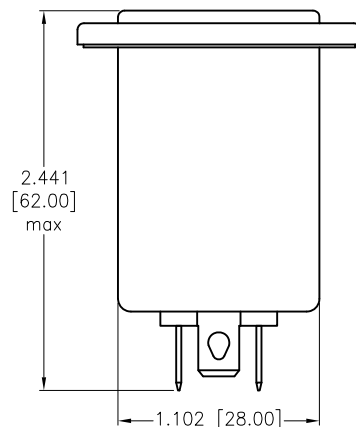
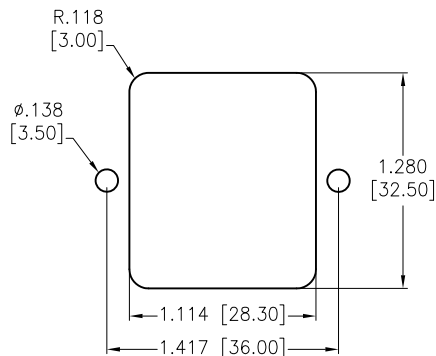

**SPECIFICATIONS:**

**Electrical:**

Voltage rating: 115/250 VAC  
 Current rating: 115/250 VAC: 10A RMS max  
 Leakage Current: Each Line To Ground  
 @115VAC/60HZ 0.4mA max  
 @250VAC/50HZ 0.8mA max

**Hipot Rating(For 1 Minute)**

A. Line to Ground: 2,250 VDC  
 B. Line to Line: 1450 VDC

IR: 50 Mohm @500 VDC Any Input or Output to Ground

Temperature Rating:  
 -25°C to +85°C

**Environmental:**

Lead free, RoHS compliant



UNLESS OTHERWISE SPECIFIED ALL DIMENSIONS ARE INCHES [MM]. TOLERANCES: EXCEPT AS NOTED			909 Rahway Avenue, Union, NJ 07083 Phone: 908-687-5000 Fax: 908-687-5710															
<table border="1"> <thead> <tr> <th colspan="2">INCHES</th> <th colspan="2">HOLES</th> </tr> </thead> <tbody> <tr> <td>.X</td> <td>± .10</td> <td>Ø.X</td> <td>±.10</td> </tr> <tr> <td>.XX</td> <td>± .020</td> <td>Ø.XX</td> <td>±.015</td> </tr> <tr> <td>.XXX</td> <td>± .015</td> <td>Ø.XXX</td> <td>±.010</td> </tr> </tbody> </table>					INCHES		HOLES		.X	± .10	Ø.X	±.10	.XX	± .020	Ø.XX	±.015	.XXX	± .015
INCHES		HOLES																
.X	± .10	Ø.X	±.10															
.XX	± .020	Ø.XX	±.015															
.XXX	± .015	Ø.XXX	±.010															
DRAWN	LH	12/6/21	<b>TITLE</b> EMI/RF POWER FILTER, FUSED INLET SOCKET W/FLANGE MOUNTING															
CHECKED	RC	12/6/21																
APPROVED																		
THIS DRAWING CONTAINS INFORMATION THAT IS PROPRIETARY AND SHOULD NOT BE USED WITHOUT PRIOR WRITTEN PERMISSION FROM ADAM TECH			<b>SIZE</b> X	<b>PART NO.</b> PLF-11B2-10A-Q	<b>REV.</b> A													
REF: S00205C		SCALE: NTS	SHEET 1 OF 2															

6

5

4

3

2

1

Rev	AWO #	Description	Date	Appr
-----	-------	-------------	------	------

SEE SHT 1 OF 2 FOR REVISION

APPROVED: \_\_\_\_\_

DATE: \_\_\_\_\_ TITLE: \_\_\_\_\_

### INSERTION LOSS(IN 50 ohm system according IEC/CISPR

(common mode)

(differential mode)

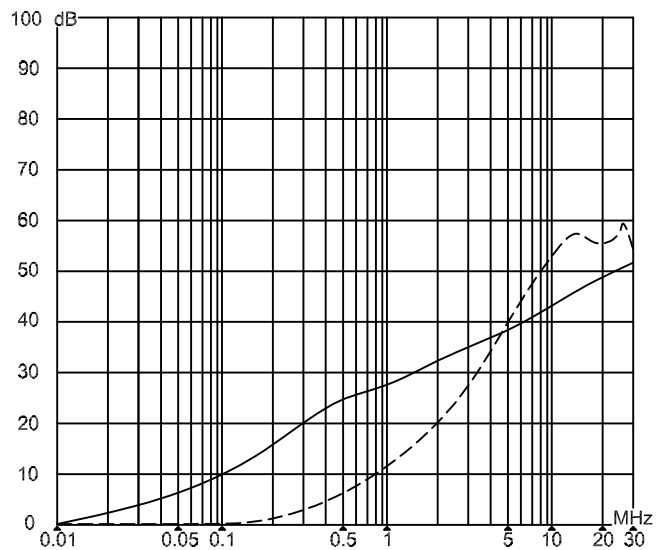

UNLESS OTHERWISE SPECIFIED ALL DIMENSIONS ARE INCHES [MM]. TOLERANCES: EXCEPT AS NOTED

INCHES		HOLES	
.x	± .10	∅x	± .10
.xx	± .020	∅xx	± .015
.xxx	± .015	∅xxx	± .010



909 Rahway Avenue,  
Union, NJ 07083  
Phone: 908-687-5000  
Fax: 908-687-5710

DRAWN	LH	12/6/21
CHECKED	RC	12/6/21
APPROVED		

TITLE	EMI/RF POWER FILTER, FUSED INLET SOCKET W/FLANGE MOUNTING	
-------	--	--

THIS DRAWING CONTAINS INFORMATION THAT IS PROPRIETARY AND SHOULD NOT BE USED WITHOUT PRIOR WRITTEN PERMISSION FROM ADAM TECH

SIZE	PART NO.	REV.
X	PLF-11B2-10A-Q	A

REF: S00205C	SCALE: NTS	SHEET 2 OF 2
--------------	------------	--------------

6

5

4

3

2

1