



REED SWITCH DEVELOPMENTS CORP.

2524 Norwood Court
Racine, WI 53403
Ph: (262)883-9060

sales@reedswitchdevelopments.com

SPECIFICATION SHEET

2451-1900-400

Alternate Part Number:

AM2451-1900-10K01

Active / Equivalent Part Numbers:

2451-1900-400 - KIT - Contains

(1) 2451-1900-100 - Magnetic Reed Sensor

(1) 2451-4006-000 - Magnetic Actuator

AM2451-1900-10K01 - KIT - Contains

(1) AM2451-1900-10-01 - Magnetic Reed Sensor

(1) AM2451-4006-00-01 - Magnetic Actuator

Sensor (Reed) - Specifications 1900

Physical		Operating		Electrical	
Configuration	SPDT	DC Contact Rating	20	W	
Form	C	AC Contact Rating	20	VA	
Contact Position	OFFSET	DC Switching Voltage	150	VDC	
Glass L	14.00	AC Switching Voltage	150	VAC	
Glass D	2.30	DC Switching Current	1.00	A	
Total L*	55.00	AC Switching Current	1.00	A	
Wire D	0.53	DC Max Carry Current	2.00	A	
Gap Location	OFFSET	AC Max Carry Current	2.00	A	
Mount Spec*	THRU	Min Breakdown Voltage	200	VDC	
Contact Material	RHODIUM	Max Initial Contact Resistance	150	mOhm	
Max Vibration Resistance	20	Typical Initial Contact Resistance	N/A	mOhm	
Max Shock Resistance (11ms)	50	Max Contact Capacitance	0.80	pF	
Lead Tensile Strength	N/A	Min Insulation Resistance	10 ⁹	Ohm	
Pull in (+/- 2AT)*	20-25				
Drop out*	5				
Operate Time	2.0				
Bounce Time	0.60				
Release Time	0.50				
Resonant Frequency	N/A				
Max Operating Frequency	250				
Operating Temperature Range	-40 - 105				
Storage Temperature	N/A				

* Pre-processed, bare reed element

Sensor - Wire/Cable Characteristics (cont.)

Type	Wire
Conductor Count	3
Length	6.0"/152.4mm
Colors	RED, BLK, WHT
Insulation Material	PVC
Gauge	24 AWG
Stranded Copper	7 STR-TC
Maximum Temp	105°C

Conductor Configuration

Common (COM) - WHITE
Normally Open (NO) - RED
Normally Closed (NC) - BLACK

Housing Characteristics 2451

Cylindrical Threaded (5/16-24)	
Length	1.500"/31.75mm
Diameter	0.313"/7.95mm
Material	Aluminum

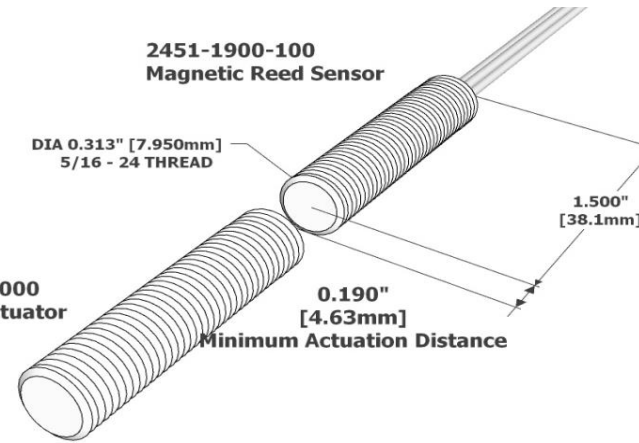

All measurements are in Inches [millimeters]

Standard Actuator: 2451-4006-000

Specifications	Description	UM
Magnetic Orientation	Through Length	
Max Operating Temp.	210/100	°F/°C
Curie Temp.	590/310	°F/°C
BR max	12.2	kGauss
BH max	35	MGOe
Coercive Force Hc	11.5	kOe
Intrinsic Coercive Force Hci	18	kOe

Std. Sensor/Actuator - Min. Actuation Dist.

2451-4006-000	0.19"/4.8mm
---------------	-------------

Assembly Certifications

UL Recognized (File #: E102207)	Y
RoHS / REACH Compliant	Y
Conflict Free Material	Y

REV DATE: 10/06/2021

DISCLAIMER NOTICE: INFORMATION FURNISHED IS PROPRIETARY, AND IS BELIEVED TO BE ACCURATE AND RELIABLE, AND IS SUBJECT TO CHANGE WITHOUT NOTICE. IT SHALL BE THE RESPONSIBILITY OF THE BUYER TO ENSURE THAT THE GOODS ARE SUFFICIENT AND SUITABLE FOR THE PURPOSE OR PURPOSES INTENDED (WHETHER BY THE BUYER OR BY ANY THIRD PARTY) AND THAT THEIR CAPACITY AND PERFORMANCE IS NOT ADVERSELY AFFECTED BY ANY ITEMS USED IN THEIR INSTALLATION (WHERE RELEVANT) AND/OR IN CONNECTION WITH THEM.

WBE Certified - State of Wisconsin - MFR CAGE CODE: 32604

www.reedswitchdevelopments.com