

QSFP-100G-PDAC5M-I-C

MSA and TAA Compliant 100GBase-CU QSFP28 to QSFP28 Direct Attach Cable (Passive Twinax, 5m, 26AWG, -40 to 85C)

Features

- QSFP28 conforms to the Small Form Factor SFF-8436
- 4-Channel Full-Duplex Passive Copper Cable Transceiver
- Support for multi-gigabit data rates: 16Gb/s – 25.78Gb/s (per channel)
- Maximum aggregate data rate: 100Gb/s (4x25.78Gb/s)
- IEEE 802.3bj 100GBase-CR4
- Copper link length up to 5m
- Power Supply: +3.3V
- Low crosstalk
- I2C based two-wire serial interface for EEPROM signature which can be customized
- Industrial Temperature -40 to +85 Celsius
- ROHS Compliant



Applications

- 100Gigabit Ethernet
- Serial Data Transmission

Product Description

This is an MSA compliant 100GBase-CU QSFP28 to QSFP28 direct attach cable that operates over passive copper with a maximum reach of 5m. It has been programmed, uniquely serialized, and data-traffic and application tested to ensure it is 100% compliant and functional. This direct attach cable is TAA (Trade Agreements Act) compliant, and is built to comply with MSA (Multi-Source Agreement) standards. We stand behind the quality of our products and proudly offer a limited lifetime warranty.

ProLabs' direct attach cables are RoHS compliant and lead-free.

TAA refers to the Trade Agreements Act (19 U.S.C. & 2501-2581), which is intended to foster fair and open international trade. TAA requires that the U.S. Government may acquire only "U.S. – made or designated country end products."



General Specifications

Parameter	Symbol	Min.	Typ.	Max.	Unit	Notes
Storage Temperature	Tstg	-40		85	°C	
Operating Temperature	Tc	-40		85	°C	
Operating Humidity Range	RH	0		85	%	
Data Rate Per Channel	DR			25.78125	Gbps	

Cable Specifications

Parameter	Symbol	Min.	Typ.	Max.	Unit	Notes
Wire Gauge			26AWG		AWG	
Cable Differential Impedance	Z	95	100	110	Ω	
Cable Outer Diameter			10.5		mm	
Cable Bend Radius (Measured at Diecast Endface)			60		mm	
Cable Flame Rating		UL CL2				

Electrical Specifications

Parameter	Symbol	Min.	Typ.	Max.	Unit	Notes
Supply Voltage	Vcc	2.95	3.3	3.6	V	
Supply Current	Icc		0.2	2	mA	1
Insertion Loss	SDD ₂₁	8		22.48	dB, at 12.8906GHz	
Input/Output Return Loss	SDD ₁₁ /SDD ₂₂	6			dB, at 12.8906GHz	
Differential to Common-Mode Return Loss	SCD ₁₁ /SCD ₂₂	Meet IEEE802.3bj 100GBASE-CR4 Spec, Equation (92-28)			dB, 10MHz to 19GHz	
Differential to Common-Mode Conversion Loss	SCD ₂₁	Meet IEEE802.3bj 100GBASE-CR4 Spec, Equation (92-29)			dB, 10MHz to 19GHz	
Common-Mode to Common-Mode Return Loss	SCC ₁₁ /SCC ₂₂	Meet IEEE802.3bj 100GBASE-CR4 Spec, Equation (92-29)			dB, 10MHz to 19GHz	
Multi-Disturber Near-End Crosstalk	MDNEXT			-35	dB, 10MHz to 19GHz	
Multi-Disturber Far-End Crosstalk	MDFEXT			-30	dB, 10MHz to 19GHz	2

Notes:

1. Dissipates power only during EEPROM read/write.
2. Far-end crosstalk depends on the cable insertion loss. The low-loss and thick-gauge cables would exhibit the highest FEXT.

Pin Descriptions

Pin	Logic	Symbol	Name/Descriptions	Ref.
1		GND	Module Ground.	1
2	CML-I	Tx2-	Transmitter Inverted Data Input.	
3	CML-I	Tx2+	Transmitter Non-Inverted Data Input.	
4		GND	Module Ground.	1
5	CML-I	Tx4-	Transmitter Inverted Data Input.	
6	CML-I	Tx4+	Transmitter Non-Inverted Data Input.	
7		GND	Module Ground.	1
8	LVTTTL-I	MODSEIL	Module Select.	2
9	LVTTTL-I	ResetL	Module Reset.	2
10		VccRx	+3.3V Receiver Power Supply.	
11	LVCNOS-I	SCL	2-Wire Serial Interface Clock.	2
12	LVCNOS-I/O	SDA	2-Wire Serial Interface Data.	2
13		GND	Module Ground.	1
14	CML-O	Rx3+	Receiver Non-Inverted Data Output.	
15	CML-O	Rx3-	Receiver Inverted Data Output.	
16		GND	Module Ground.	1
17	CML-O	Rx1+	Receiver Non-Inverted Data Output.	
18	CML-O	Rx1-	Receiver Inverted Data Output.	
19		GND	Module Ground.	1
20		GND	Module Ground.	1
21	CML-O	Rx2-	Receiver Inverted Data Output.	
22	CML-O	Rx2+	Receiver Non-Inverted Data Output.	
23		GND	Module Ground.	1
24	CML-O	Rx4-	Receiver Inverted Data Output.	
25	CML-O	Rx4+	Receiver Non-Inverted Data Output.	
26		GND	Module Ground.	1
27	LVTTTL-O	ModPrsL	Module Present. Internally pulled down to GND.	
28	LVTTTL-O	IntL	Interrupt output should be pulled up on the host board.	2
29		VccTx	+3.3V Transmitter Power Supply.	
30		Vcc1	+3.3V Power Supply.	
31	LVTTTL-I	LPMode	Low-Power Mode.	2
32		GND	Module Ground.	1
33	CML-I	Tx3+	Transmitter Non-Inverted Data Input.	
34	CML-I	Tx3-	Transmitter Inverted Data Input.	
35		GND	Module Ground.	1
36	CML-I	Tx1+	Transmitter Non-Inverted Data Input.	
37	CML-I	Tx1-	Transmitter Inverted Data Input.	
38		GND	Module Ground.	1

Notes:

1. Module circuit ground is isolated from module chassis ground within the module.
2. Open collector. Should be pulled up with 4.7kΩ-10kΩ on the host board to a voltage between 3.15V and 3.6V.

Electrical Pin-Out Details

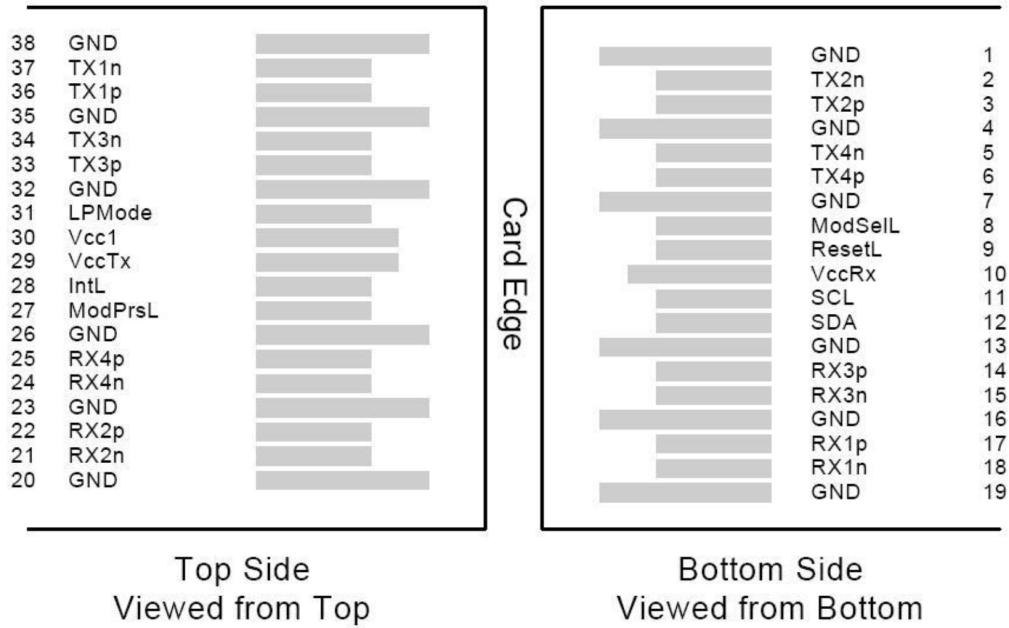

26AWG Bend Radius

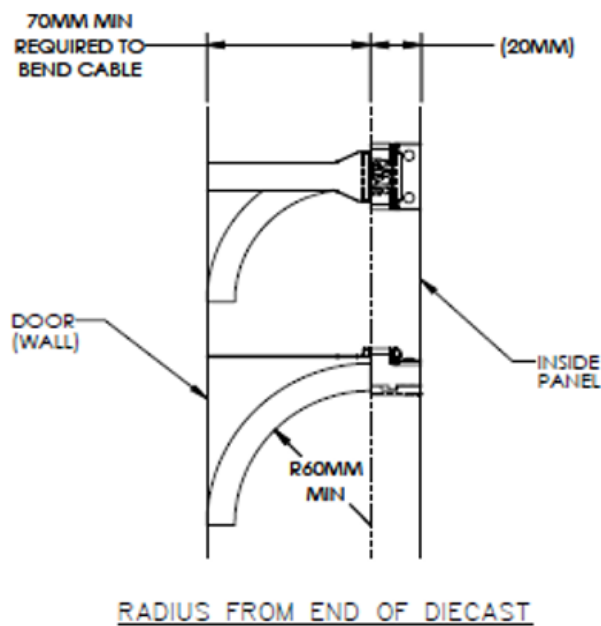

Signal Description

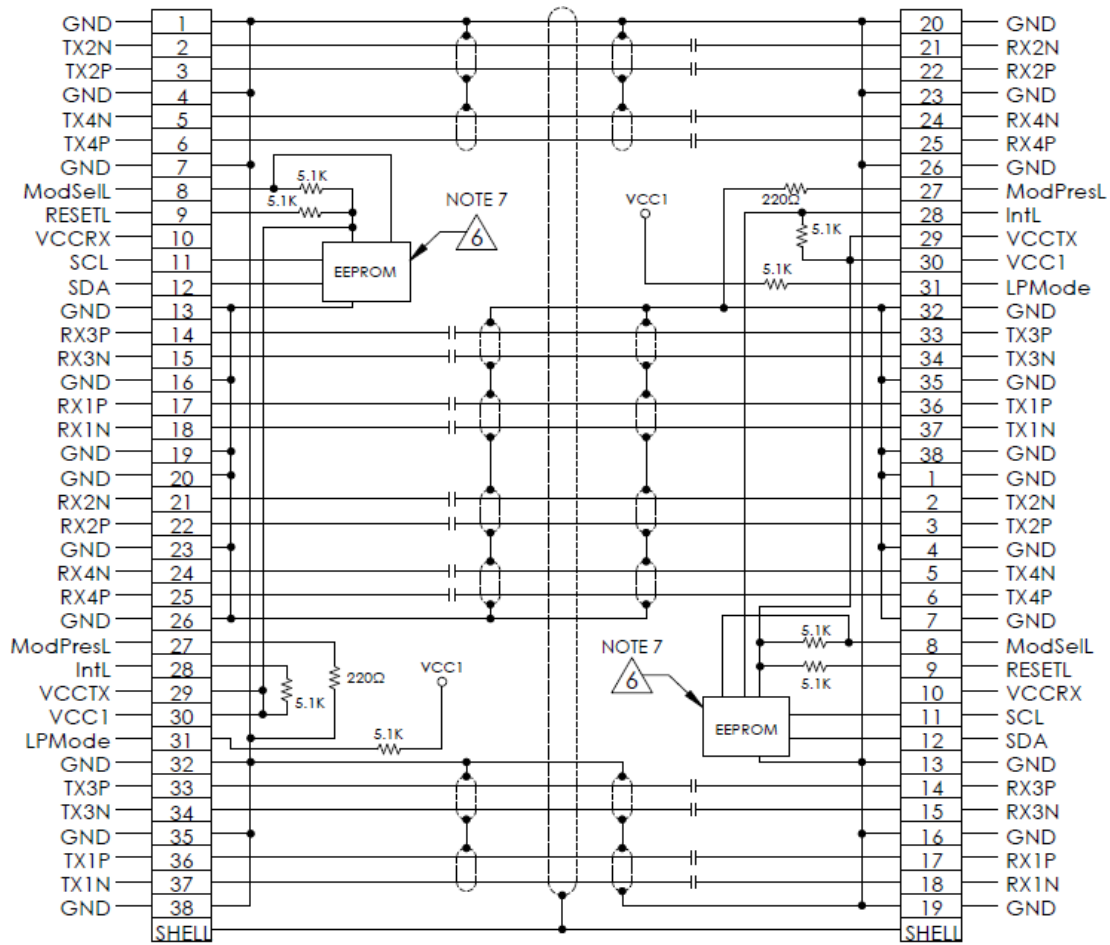

NOTE: DC BLOCKING CAP VALUE IS 0.1 μ F
 EPROM CONNECTED TO VCCTX

Mechanical Specifications

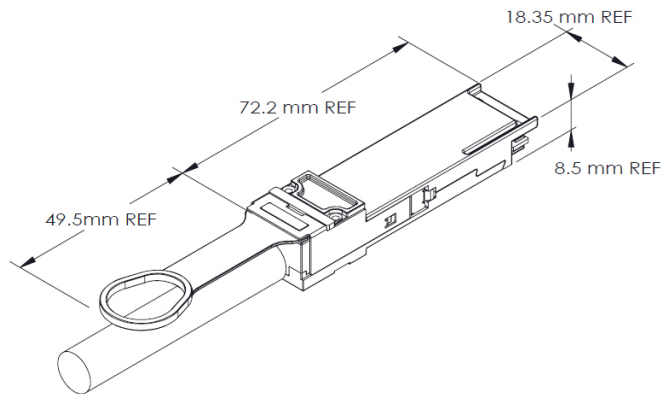
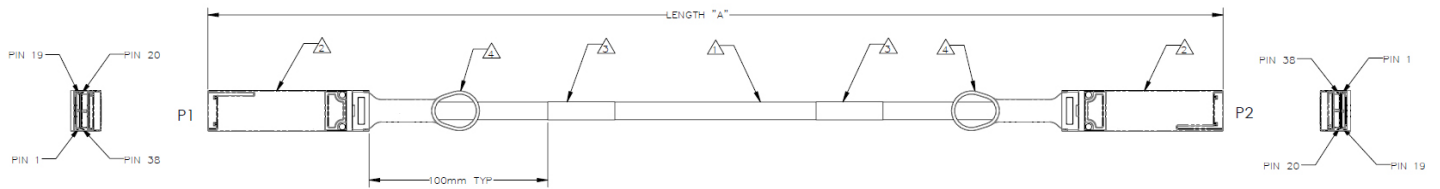

QSFP Diecast Dimensions

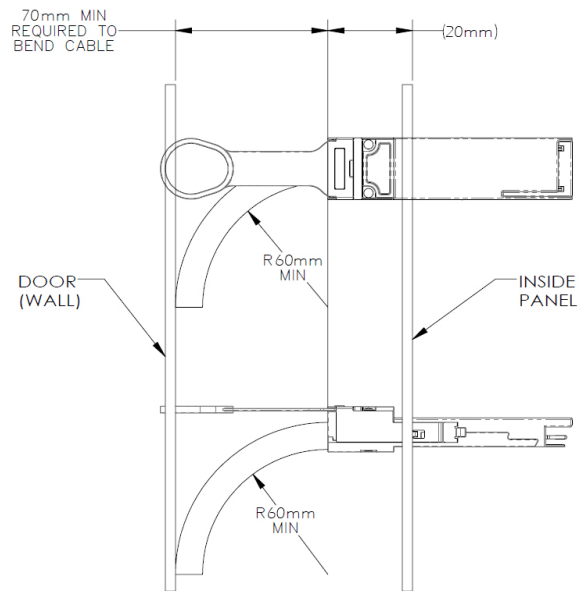

Radius from Edge of Diecast

Notes:

1. 26AWG, 8-PR, PVC Black, UL CL2, AWM Style 20276 80°C.
2. Plug, QSFP28, Reference SFF-8661.
3. Label.
4. Lanyard, Green, UL 94V-0.

About ProLabs

Our experience comes as standard; for over 15 years ProLabs has delivered optical connectivity solutions that give our customers freedom and choice through our ability to provide seamless interoperability. At the heart of our company is the ability to provide state-of-the-art optical transport and connectivity solutions that are compatible with over 90 optical switching and transport platforms.

Complete Portfolio of Network Solutions

ProLabs is focused on innovations in optical transport and connectivity. The combination of our knowledge of optics and networking equipment enables ProLabs to be your single source for optical transport and connectivity solutions from 100Mb to 400G while providing innovative solutions that increase network efficiency. We provide the optical connectivity expertise that is compatible with and enhances your switching and transport equipment.

Trusted Partner

Customer service is our number one value. ProLabs has invested in people, labs and manufacturing capacity to ensure that you get immediate answers to your questions and compatible product when needed. With Engineering and Manufacturing offices in the U.K. and U.S. augmented by field offices throughout the U.S., U.K. and Asia, ProLabs is able to be our customers best advocate 24 hours a day.

Contact Information

ProLabs US

Email: sales@prolabs.com

Telephone: 952-852-0252

ProLabs UK

Email: salessupport@prolabs.com

Telephone: +44 1285 719 600