

Ultra-Low Noise XO / VCXO

ABLNO

Request Samples



Check Inventory



ESD Sensitive



9.2 x 14.8 x 5.5 mm

RoHS/RoHS II Compliant

MSL Level = 1

Features

- High "Q", 3rd Overtone Crystal Technology
- Ultra Low Phase Noise -162 dBc/Hz Typ. @ 10kHz offset, 100MHz carrier
- Standard LVCMOS RF Output
- Wide Operating Temperature (-40°C to +85°C) standard
- ±28 ppm Max. All inclusive Stability (including Aging) over 10-years
- Available Frequency range from 24.576MHz to 200.00MHz

Applications

- Satellite Modem Communication Systems
- COTS - Military communications
- Avionics
- Low Phase Noise Signal Sources
- High Definition TV
- Test & Measurement
- Ultra Low Jitter RF Communication Circuitry

Key Electrical Specifications

Parameters	Min.	Typ.	Max.	Units	Notes
RF Output Frequency Range	24.576		200.00	MHz	
Standard Available Frequencies	24.576 MHz, 50.00MHz, 80.00MHz, 81.92MHz, 92.16MHz, 96.00MHz, 98.304MHz, 100MHz, 104.00MHz, 106.25MHz, 120.00MHz, 122.88MHz, 125.00MHz, 150.00MHz, 155.52MHz, 156.250MHz, 200MHz				Custom frequencies available upon request
Supply Voltage (Vdd)	3.135	3.300	3.465	Volts	
Current Drain	24.576MHz ~ 99.999MHz		25.00	mA	
	100MHz ~ 149.999MHz		35.00		
	≥ 150.00MHz		40.00		
Waveform	LVCMOS				
Output Load			15	pF	
V _{OH}	0.9*Vdd			Volts	
V _{OL}			0.1*Vdd	Volts	
Symmetry	45	50	55	%	
Rise & Fall Times			3.0	ns	
Operating Temperature Range	-40		+85	°C	
Frequency Stability					
Over (-40° C to +85°C)		±12.00	±18.00	ppm	Relative to measured frequency @ 25°C
ALL effects, including Aging			±28.00	ppm	
Storage Temperature Range	-40		+90	°C	



5101 Hidden Creek Ln Spicewood TX 78669
 Phone: 512-371-6159 | Fax: 512-351-8858
 For terms and conditions of sales, please visit:
www.abracon.com

REVISED: 09-02-22

ABRACON IS
 ISO9001-2015
 CERTIFIED

Ultra-Low Noise XO / VCXO

ABLNO

Request Samples



Check Inventory



ESD Sensitive



9.2 x 14.8 x 5.5 mm
RoHS/RoHS II Compliant
 MSL Level = 1

Parameters		Min.	Typ.	Max.	Units	Notes
Aging	First Year			±2.00	ppm	
	5-Years			±5.00	ppm	
	10-Years			±7.00	ppm	
Phase Noise (24.576MHz Carrier)						Vdd=3.3V
@ 10	Hz offset		-90	-82	dBc/Hz	<i>Note #1 & #2</i>
@ 100	Hz offset		-120	-115	dBc/Hz	
@ 1,000	Hz offset		-145	-140	dBc/Hz	
@ 10,000	Hz offset		-165	-160	dBc/Hz	
@ 100,000	Hz offset		-166	-165	dBc/Hz	
@ 1,000,000	Hz offset		-166	-165	dBc/Hz	
Phase Noise (50MHz Carrier)						Vdd=3.3V
@ 10	Hz offset		-90	-82	dBc/Hz	<i>Note #1 & #2</i>
@ 100	Hz offset		-120	-115	dBc/Hz	
@ 1,000	Hz offset		-145	-140	dBc/Hz	
@ 10,000	Hz offset		-165	-160	dBc/Hz	
@ 100,000	Hz offset		-166	-165	dBc/Hz	
@ 1,000,000	Hz offset		-166	-165	dBc/Hz	
RMS Jitter (12kHz ~ 20MHz BW)			< 100	125	Femto Seconds	0.125 ps Max.
Phase Noise (100MHz Carrier)						Vdd=3.3V
@ 10	Hz offset		-88	-82	dBc/Hz	<i>Note #1 & #2</i>
@ 100	Hz offset		-118	-115	dBc/Hz	
@ 1,000	Hz offset		-141	-138	dBc/Hz	
@ 10,000	Hz offset		-160	-155	dBc/Hz	
@ 100,000	Hz offset		-161	-160	dBc/Hz	
@ 1,000,000	Hz offset		-165	-160	dBc/Hz	
RMS Jitter (12kHz ~ 20MHz BW)			< 50	100	Femto Seconds	0.10 ps Max.



5101 Hidden Creek Ln Spicewood TX 78669
 Phone: 512-371-6159 | Fax: 512-351-8858
 For terms and conditions of sales, please visit:
www.abracon.com

REVISED: 09-02-22

ABRACON IS
 ISO9001-2015
 CERTIFIED

Ultra-Low Noise XO / VCXO

ABLNO

Request Samples



Check Inventory



ESD Sensitive



9.2 x 14.8 x 5.5 mm
RoHS/RoHS II Compliant
MSL Level = 1

Parameters	Min.	Typ.	Max.	Units	Notes
Phase Noise (156.25MHz Carrier)					Vdd=3.3V
@ 10 Hz offset		-75	-70	dBc/Hz	Note #1 & #2
@ 100 Hz offset		-110	-105	dBc/Hz	
@ 1,000 Hz offset		-140	-135	dBc/Hz	
@ 10,000 Hz offset		-155	-150	dBc/Hz	
@ 100,000 Hz offset		-161	-160	dBc/Hz	
@ 1,000,000 Hz offset		-165	-160	dBc/Hz	
RMS Jitter (12kHz ~ 20MHz BW)		< 50	100	Femto Seconds	0.10 ps Max.
Phase Noise (200MHz Carrier)					Vdd=3.3V
@ 10 Hz offset		-75	-70	dBc/Hz	Note #1 & #2
@ 100 Hz offset		-105	-100	dBc/Hz	
@ 1,000 Hz offset		-135	-130	dBc/Hz	
@ 10,000 Hz offset		-150	-145	dBc/Hz	
@ 100,000 Hz offset		-155	-150	dBc/Hz	
RMS Jitter (12kHz ~ 20MHz BW)		< 20	30	Femto Seconds	0.03 ps Max
Electrical Frequency Adjustment					
Control Voltage Range (Vc)	0.0	1.65	3.30	Volts	
Frequency Pull Range	±28.00		±55.00	ppm	Referenced to the carrier
Frequency Pull Slope		Positive			
Control Voltage Port Impedance	10			kΩ	
Control Port Linearity			±10	%	

Note #1:

Maximum Phase Noise is verified on 100% of the parts at 25°C ± 3°C.

Note #2:

The above specified Phase Noise & Jitter is with the oscillator device configured as a VCXO. In XO configuration, the Phase Noise will be slightly better at each offset between 10Hz and 10 kHz, by approximately -3dB to -5dB.



5101 Hidden Creek Ln Spicewood TX 78669
Phone: 512-371-6159 | Fax: 512-351-8858
For terms and conditions of sales, please visit:
www.abracon.com

REVISED: 09-02-22

ABRACON IS
ISO9001-2015
CERTIFIED

Ultra-Low Noise XO / VCXO

ABLNO

Request Samples



Check Inventory



ESD Sensitive



9.2 x 14.8 x 5.5 mm
RoHS/RoHS II Compliant
MSL Level = 1

Options and Part Identification:

ABLNO - Frequency (MHz) -

Fixed Clock Vs. VCXO Option	
Blank	Fixed Clock Oscillator
V	VCXO (± 28 ppm min. Pull)

Tape & Reel Options	
Blank	< 250 units on cut tape
T2	250 units per reel
T	1,000 units per reel

Ultra-Low Noise XO / VCXO

ABLNO

Request Samples



Check Inventory



ESD Sensitive



9.2 x 14.8 x 5.5 mm
RoHS/RoHS II Compliant
MSL Level = 1

Typical Phase Noise Performance @ 50.00 MHz Carrier

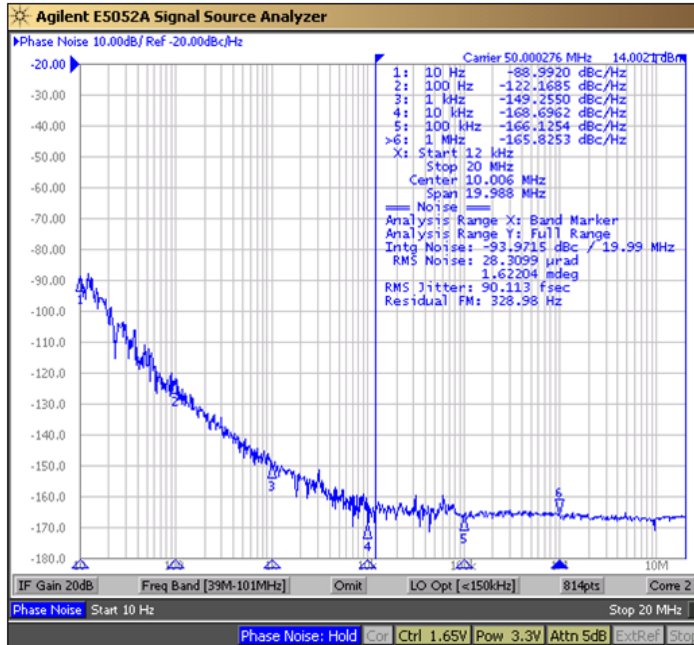

Typical Phase Noise Performance @ 100.00 MHz Carrier

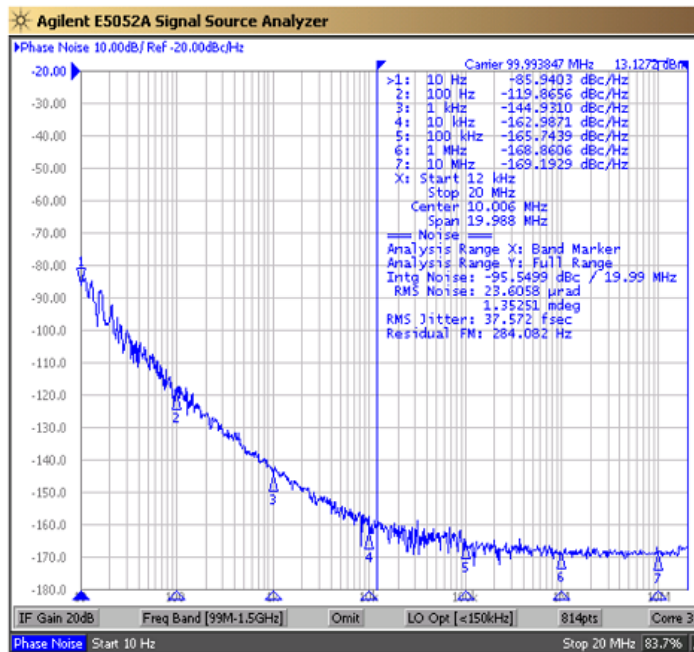

5101 Hidden Creek Ln Spicewood TX 78669
Phone: 512-371-6159 | Fax: 512-351-8858
For terms and conditions of sales, please visit:
www.abracon.com

REVISED: 09-02-22

ABRACON IS
ISO9001-2015
CERTIFIED

Ultra-Low Noise XO / VCXO

ABLNO

Request Samples



Check Inventory



ESD Sensitive



9.2 x 14.8 x 5.5 mm
RoHS/RoHS II Compliant
MSL Level = 1

Frequency Pull versus Control Voltage (referenced to 100.000MHz)

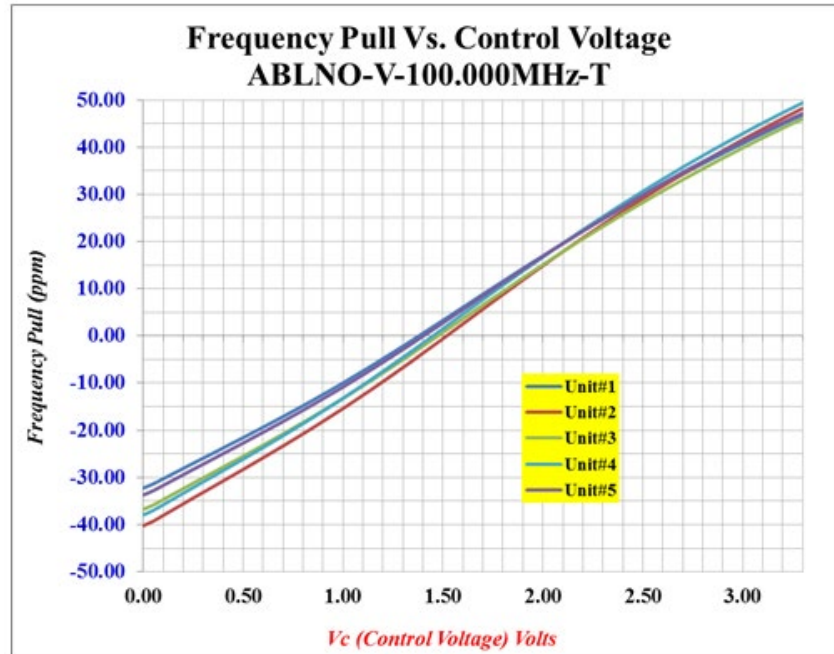

Current Drain versus Control Voltage @ Vdd = +3.3V

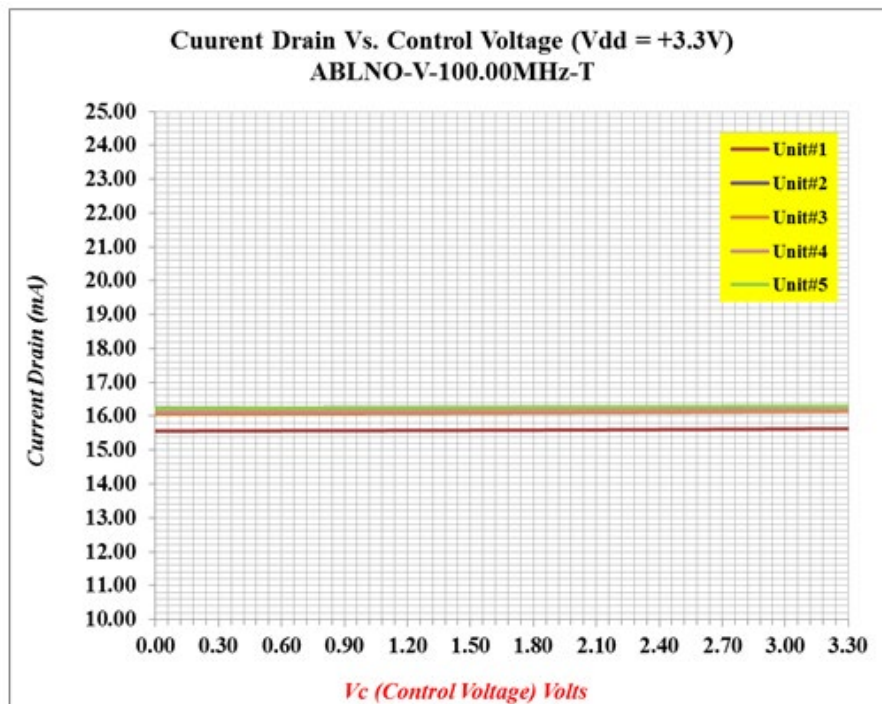

Ultra-Low Noise XO / VCXO

ABLNO

Request Samples



Check Inventory



ESD Sensitive



9.2 x 14.8 x 5.5 mm
RoHS/RoHS II Compliant
MSL Level = 1

Frequency Stability Vs. Temperature @ Vdd = +3.3V (referenced to measured frequency @ 25°C)

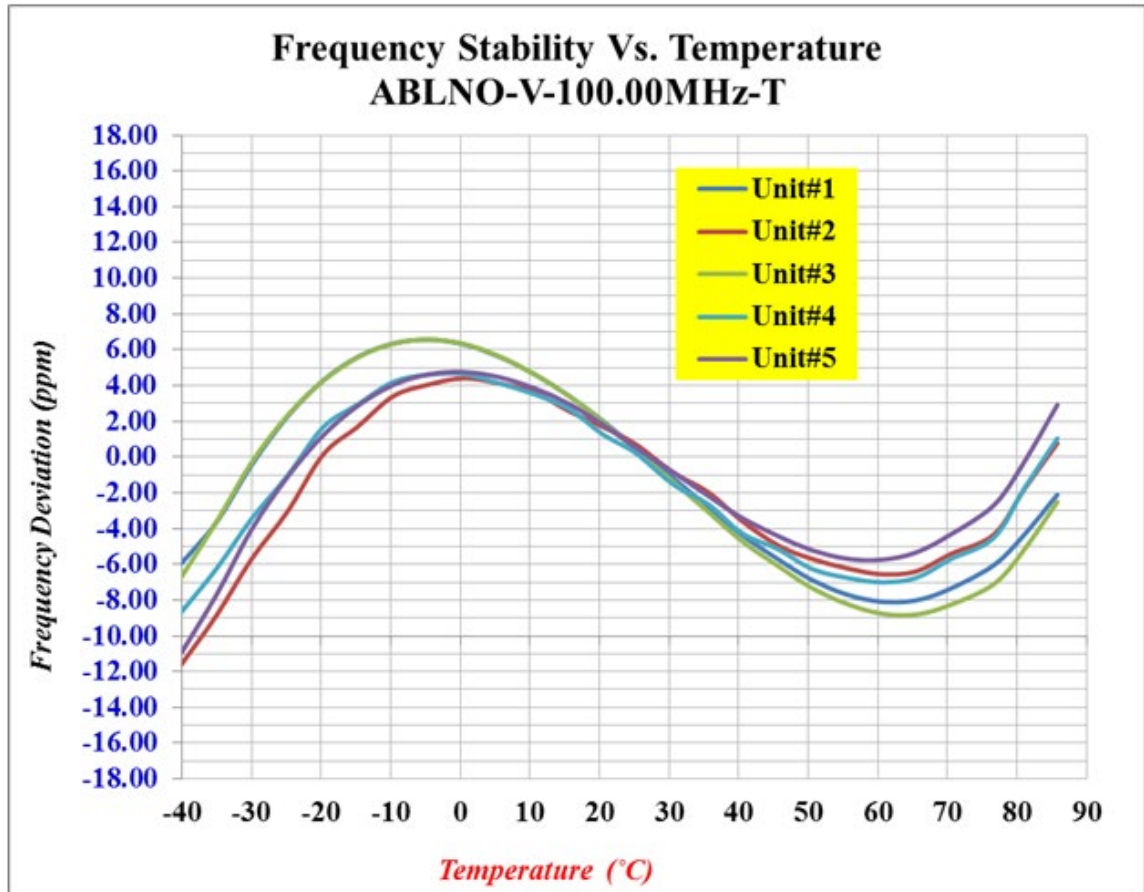

Ultra-Low Noise XO / VCXO

ABLNO

Request Samples



Check Inventory



ESD Sensitive



9.2 x 14.8 x 5.5 mm
RoHS/RoHS II Compliant
 MSL Level = 1

Mechanical Dimensions

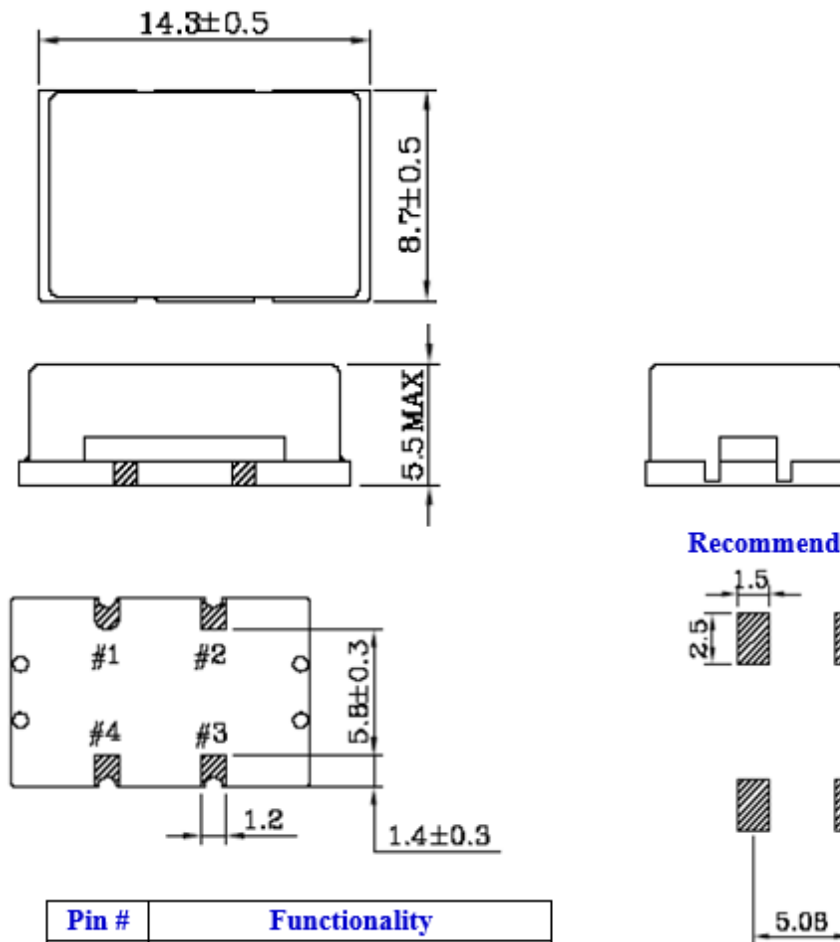

Recommended Land Pattern

Pin #	Functionality
1	Voltage Control (Vc) for VCXO No Connect (N/C) for XO
2	Ground
3	RF Output
4	Vdd

Dimensions= mm

Ultra-Low Noise XO / VCXO

ABLNO

Request Samples



Check Inventory



ESD Sensitive



9.2 x 14.8 x 5.5 mm
RoHS/RoHS II Compliant
MSL Level = 1

Reflow Profile [JEDEC J-STD-020]

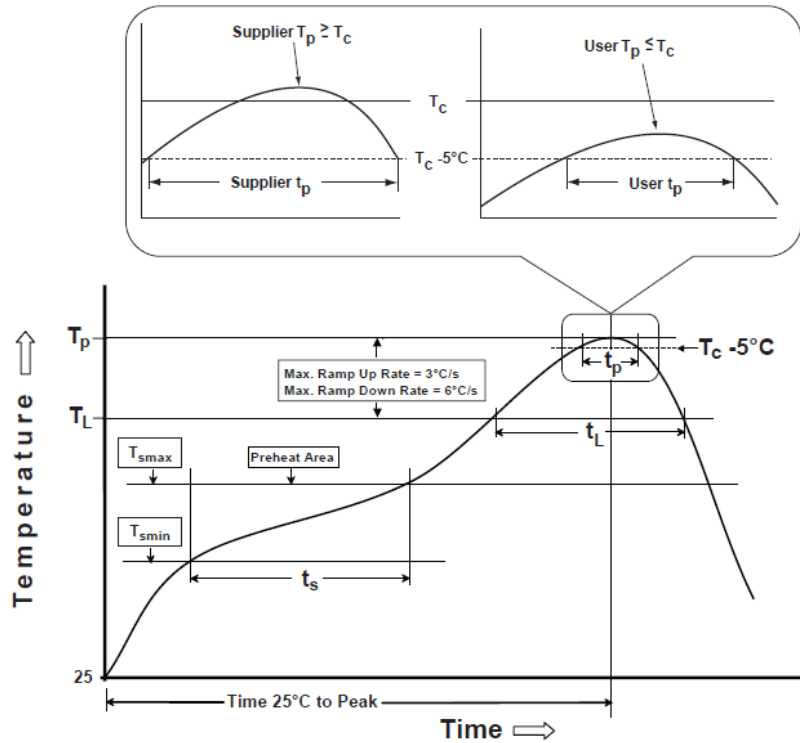

Table 1

SnPb Eutectic Process Classification Temperatures (T_c)

Package Thickness	Volume mm ³ <350	Volume mm ³ ≥350
<2.5 mm	235 °C	220 °C
≥2.5 mm	220 °C	220 °C

Table 2

Pb-Free Process Classification Temperatures (T_c)

Package Thickness	Volume mm ³ <350	Volume mm ³ 350-2000	Volume mm ³ >2000
<1.6 mm	260 °C	260 °C	260 °C
1.6 mm - 2.5 mm	260 °C	250 °C	245 °C
>2.5 mm	250 °C	245 °C	245 °C

Profile Feature	Sn-Pb Eutectic Assembly	Pb-Free Assembly
Preheat / soak		
Temperature minimum (T _{smin})	100°C	150°C
Temperature maximum (T _{smax})	150°C	200°C
Time (T _{smin} to T _{smax}) (t _s)	60 - 120 sec.	60 - 120 sec.
Average ramp-up rate (T _{smax} to T _p)	3°C/sec. max	3°C/sec. max
Liquidous temperature (T _L)	183°C	217°C
Time at liquidous (t _L)	60 - 150 sec.	60 - 150 sec.
Peak package body temperature (T _p)*	see Table 1	see Table 2
Time (t _p)** within 5°C of the specified classification temperature (T _c)	20 sec.	30 sec.
Ramp-down rate (T _p to T _{smax})	6°C/sec. max	6°C/sec. max
Time 25°C to peak temperature	6 min. max	8 min. max
Reflow cycles	2 max	2 max

*Tolerance for peak profile temperature (T_p) is defined as a supplier minimum and a user maximum.

**Tolerance for time at peak profile temperature (t_p) is defined as supplier minimum and a user maximum.

Ultra-Low Noise XO / VCXO

ABLNO

Request Samples



Check Inventory



ESD Sensitive



9.2 x 14.8 x 5.5 mm
RoHS/RoHS II Compliant
 MSL Level = 1

Packaging

(1,000) units per reel (option T), (250) units per reel available (option # T2)

REEL

MAT'L : P.S
 COLOR : WHITE&BLACK
 SCALE : 1/4

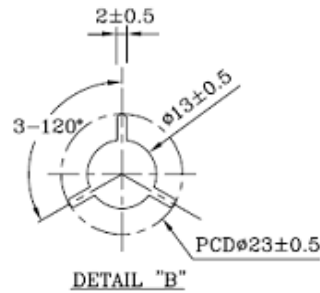
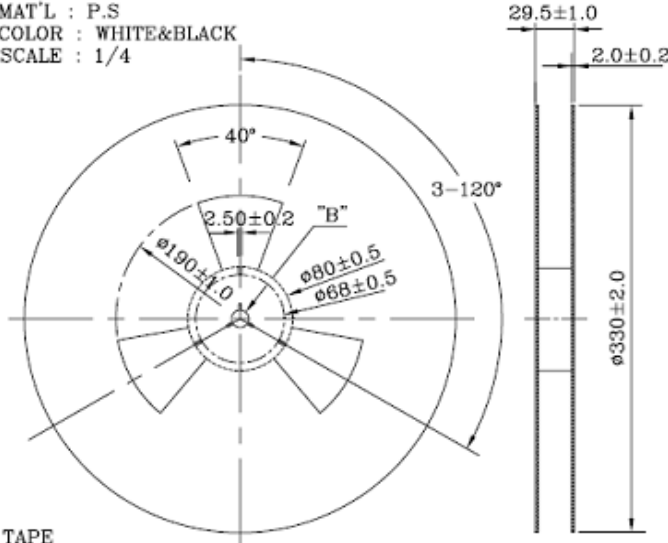

TAPE

MAT'L : P.S
 COLOR : WHITE&BLACK
 REFERENCE R=0.5

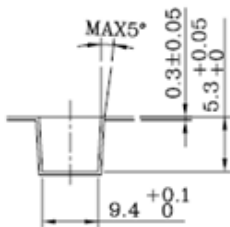
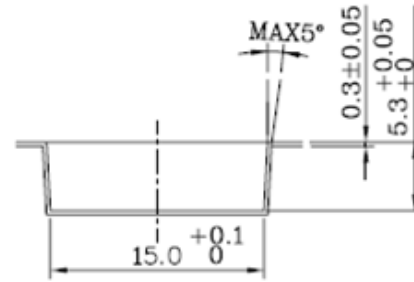
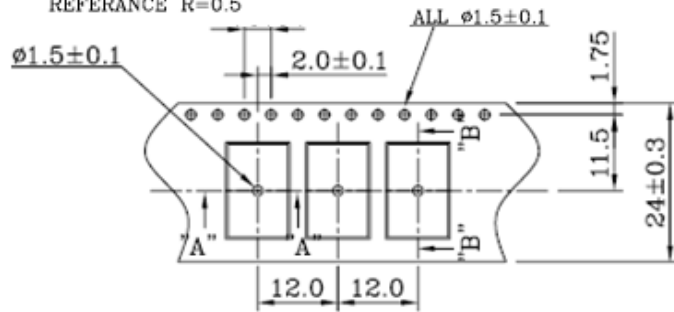

SECTION "A"- "A"

SECTION "B"- "B"

- 1.COVER TAPE : 21mm(WIDTH) * 0.06mm(t) MAT'L : PET
- 2.COLOR : WHITE

Dimensions= mm

ATTENTION: Abracon LLC's products are COTS – Commercial-Off-The-Shelf products; suitable for Commercial, Industrial and, where designated, Automotive Applications. Abracon's products are not specifically designed for Military, Aviation, Aerospace, Life-dependent Medical applications or any application requiring high reliability where component failure could result in loss of life and/or property. For applications requiring high reliability and/or presenting an extreme operating environment, written consent and authorization from Abracon LLC is required. Please contact Abracon LLC for more information.



5101 Hidden Creek Ln Spicewood TX 78669
 Phone: 512-371-6159 | Fax: 512-351-8858
 For terms and conditions of sales, please visit:
www.abracon.com

REVISED: 09-02-22

ABRACON IS
 ISO9001-2015
 CERTIFIED