

SN series

Proportional single axis fingertip controllers •
non-contacting Hall effect technology



DISTINCTIVE FEATURES

- Analog or PWM outputs
- Smooth and noise-free movement
- Friction "stay-put"
- 12 bit resolution
- Barrel and bullet style handles available



ENVIRONMENTAL SPECIFICATIONS

- Operating Temperature: -20 °C to +70 °C (-4 °F to +158 °F)
- Storage Temperature: -40 °C to +70 °C (-40 °F to +158 °F)
- Sealing: No sealing - Indoor use only.



ELECTRICAL SPECIFICATIONS

- Power supply: 5V ±0.5V transient free
- Reverse Polarity Max: -10VDC
- Overvoltage Max: 20VDC
- Output Impedance: 10 Ω
- Sensor: Hall effect
- Output at Center: $V/2 \pm (5\% \times \text{Gain})$
- Output Voltage: 0 V to 5 V (See gain options)
- Current Consumption Typ: 13 mA
- Load: Minimum 10 K, preferred 100 K+



MECHANICAL SPECIFICATIONS

- Operating Force: 0.5 N
- Mechanical Angle of Movement: 63° ($\pm 31.5^\circ$ from center)
- Mechanical Life: 1 million lifecycles
- Mass/weight: 65 g (0.14 lbs)
- Lever Action: Friction clutch

The company reserves the right to change specifications without notice.



SN series

Proportional single axis fingertip controllers • non-contacting Hall effect technology



MATERIALS

- Lever: Acetyl (black)
- Housing: Mineral filled nylon (black)
- Handles: Aluminum (silver anodized)
- Screening plates: Mild steel (zinc plated)



CONNECTIONS

OUTPUT VOLTAGE POLARITY

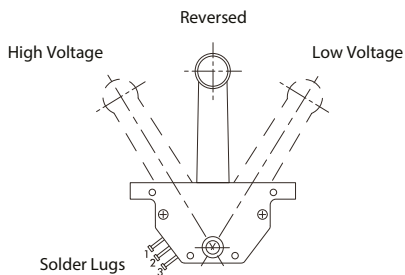
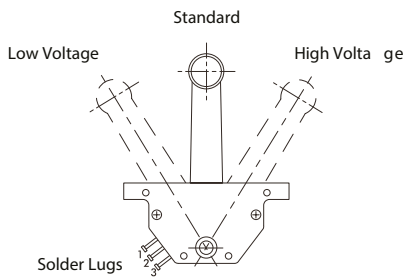

WIRING SPECIFICATION

PIN 1 (upper)	5 V
PIN 2 (middle)	Output
PIN 3 (lower)	0 V

Additional cable outputs and customer specific connectors are available on request.

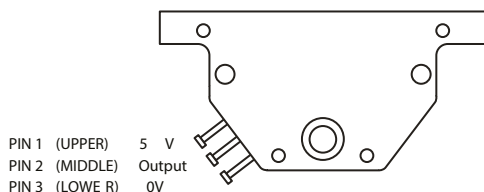

MOUNTING

INSTALLATION DIMENSIONS

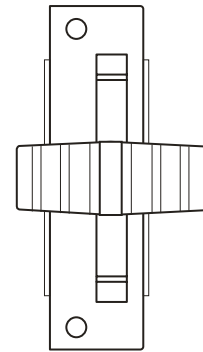
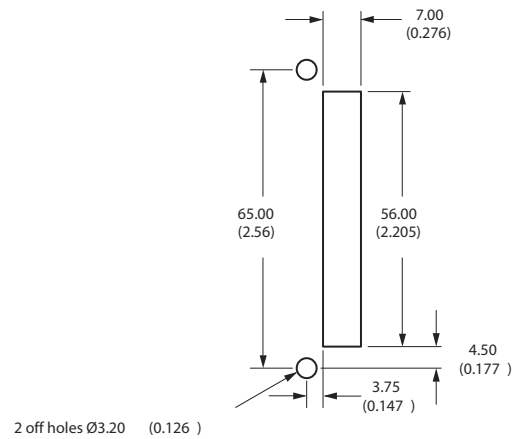

SN series

Proportional single axis fingertip controllers • non-contacting Hall effect technology



BUILD YOUR PART NUMBER

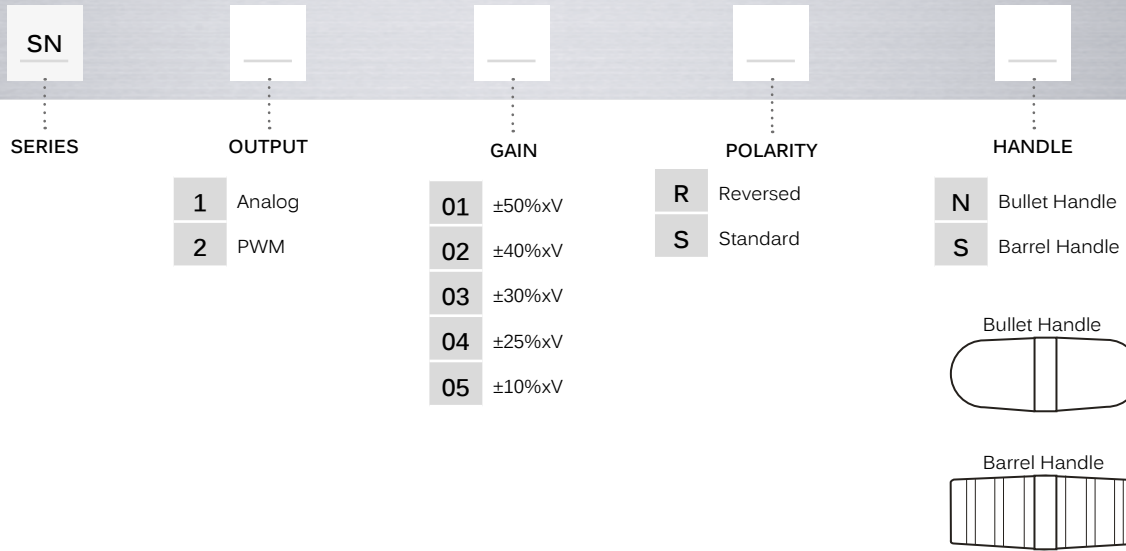

DIMENSIONS

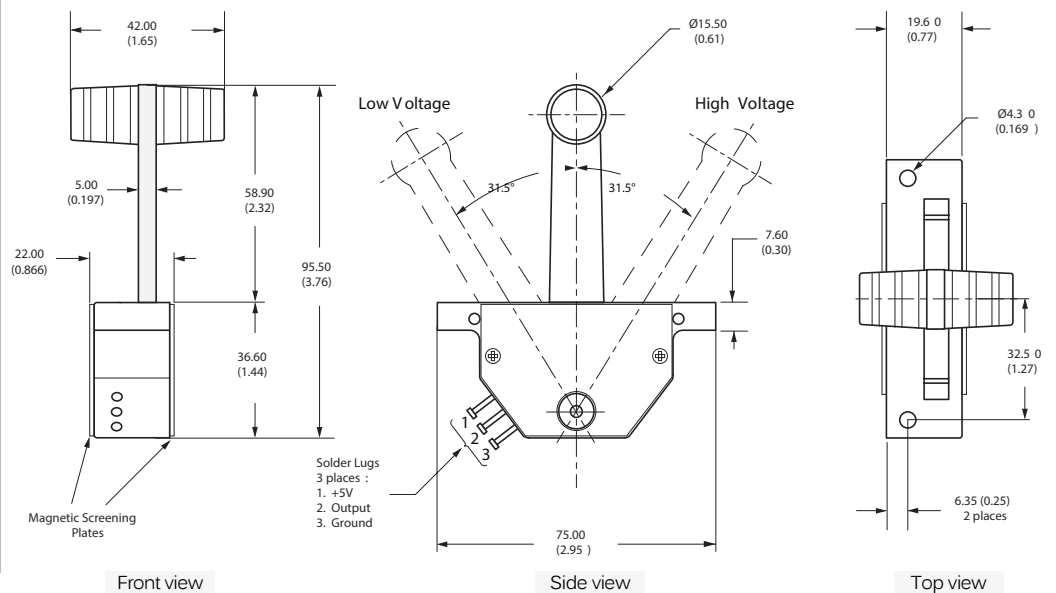

SN series

Proportional single axis fingertip controllers • non-contacting Hall effect technology



GAIN OPTIONS

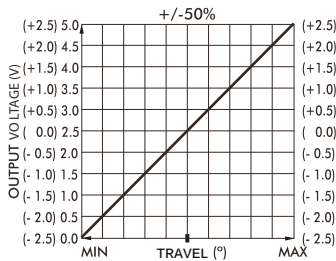

1

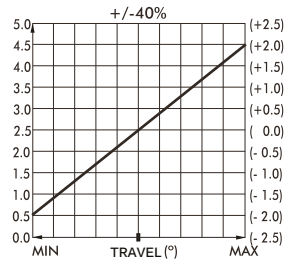

2

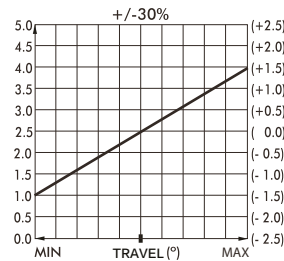

3

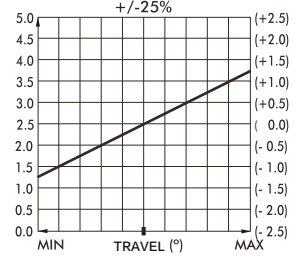

4

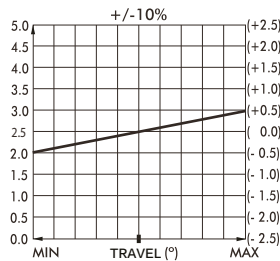

5

- The voltage output on the wiper, at full scale deflection is determined by the gain. The gain is expressed as a percentage of the voltage supplied. Therefore (assuming a 5 V supply), a SN series specified with $\pm 25\%$ gain would yield 1.25 V at South and 3.75 V at North.

- A range of gain options are available as standard.

- All SN series are supplied pre-set and no further calibration is needed throughout the lifetime of operation.



CONFIGURATION SPECIFICATIONS

MECHANISM

The SN series utilizes high quality ball bearings at the pivot point of its lever and uses a PTFE friction clutch assembly to create a smooth, damped, put and stay feel of the lever to ensure a consistent feel over the life of the product.

POWER SUPPLY

The SN series is designed to be powered by a regulated $5V \pm 0.5V$ power supply. The output is ratiometric, making a stable, noise free, power supply essential. The power supply to the SN series should be carefully regulated to be within tolerance. Should the power supply change outside specified tolerances, permanent damage may occur.

MAGNETIC IMMUNITY AND SYSTEM DESIGN

The SN series faders incorporate magnetic shielding, however, mounting or operating the SN series close to strong magnetic fields is not recommended. System designers should follow best practice when incorporating the SN series into their products. Care should be taken to disconnect the power supply properly and to employ adequate EMC shielding.

MOUNTING

When mounting the SN series, care should be taken to site it in a position that does not make it vulnerable to damage when in use. The SN series must not be subject to water spray, excessive humidity or dust. The handle is supplied separately, in two halves that must be screwed together after the SN series has been mounted to the panel.

OUTPUT IMPEDANCE

The voltage output at the center and at each end of travel are specified across an infinite load, with no current flowing. The output impedance specified in the electrical specification should be taken into account when designing a system. Load resistance of less than 10K Ohms is not recommended.