



Figure similar

SIRIUS soft starter 200-600 V 470 A, 110-250 V AC Spring-loaded terminals
Analog output

product brand name	SIRIUS
product category	Hybrid switching devices
product designation	Soft starter
product type designation	3RW50
manufacturer's article number	<ul style="list-style-type: none"> • of standard HMI module usable 3RW5980-0HS01 • of high feature HMI module usable 3RW5980-0HF00 • of communication module PROFINET standard usable 3RW5980-0CS00 • of communication module PROFIBUS usable 3RW5980-0CP00 • of communication module Modbus TCP usable 3RW5980-0CT00 • of communication module Modbus RTU usable 3RW5980-0CR00 • of communication module Ethernet/IP 3RW5980-0CE00 • of circuit breaker usable at 400 V 3VA2580-6HN32-0AA0; Type of assignment 1, Iq = 65 kA • of circuit breaker usable at 500 V 3VA2580-6HN32-0AA0; Type of assignment 1, Iq = 65 kA • of the gG fuse usable up to 690 V 2x3NA3365-6; Type of coordination 1, Iq = 65 kA • of full range R fuse link for semiconductor protection usable up to 690 V 3NE1 436-2; Type of coordination 2, Iq = 65 kA • of back-up R fuse link for semiconductor protection usable up to 690 V 3NE3 340-8; Type of coordination 2, Iq = 65 kA • of line contactor usable up to 480 V 3RT1076 • of line contactor usable up to 690 V 3RT1076
General technical data	
starting voltage [%]	30 ... 100 %
stopping voltage [%]	50 %; non-adjustable
start-up ramp time of soft starter	0 ... 20 s
ramp-down time of soft starter	0 ... 20 s
current limiting value [%] adjustable	130 ... 700 %
certificate of suitability	
• CE marking	Yes
• UL approval	Yes
• CSA approval	Yes
product component	
• HMI-High Feature	No
• is supported HMI-Standard	Yes
• is supported HMI-High Feature	Yes
product feature integrated bypass contact system	Yes
number of controlled phases	2
trip class	CLASS 10A / 10E (preset) / 20E; acc. to IEC 60947-4-2
buffering time in the event of power failure	
• for main current circuit	100 ms









• for control circuit	100 ms
insulation voltage rated value	600 V
degree of pollution	3, acc. to IEC 60947-4-2
impulse voltage rated value	6 kV
blocking voltage of the thyristor maximum	1 600 V
service factor	1
surge voltage resistance rated value	6 kV
maximum permissible voltage for protective separation	
• between main and auxiliary circuit	600 V
shock resistance	15 g / 11 ms, from 12 g / 11 ms with potential contact lifting
vibration resistance	15 mm to 6 Hz; 2g to 500 Hz
utilization category according to IEC 60947-4-2	AC-53a
reference code according to IEC 81346-2	Q
Substance Prohibitance (Date)	09/23/2019

product function	
• ramp-up (soft starting)	Yes
• ramp-down (soft stop)	Yes
• Soft Torque	Yes
• adjustable current limitation	Yes
• pump ramp down	Yes
• intrinsic device protection	Yes
• motor overload protection	Yes; Electronic motor overload protection
• evaluation of thermistor motor protection	No
• auto-RESET	Yes
• manual RESET	Yes
• remote reset	Yes; By turning off the control supply voltage
• communication function	Yes
• operating measured value display	Yes; Only in conjunction with special accessories
• error logbook	Yes; Only in conjunction with special accessories
• via software parameterizable	No
• via software configurable	Yes
• PROFInergy	Yes; in connection with the PROFINET Standard communication module
• voltage ramp	Yes
• torque control	No
• analog output	Yes; 4 ... 20 mA (default) / 0 ... 10 V (parameterizable with High Feature HMI)

Power Electronics	
operational current	
• at 40 °C rated value	470 A
• at 50 °C rated value	416 A
• at 60 °C rated value	380 A
operating voltage	
• rated value	200 ... 600 V
relative negative tolerance of the operating voltage	-15 %
relative positive tolerance of the operating voltage	10 %
operating power for 3-phase motors	
• at 230 V at 40 °C rated value	132 kW
• at 400 V at 40 °C rated value	250 kW
• at 500 V at 40 °C rated value	315 kW
Operating frequency 1 rated value	50 Hz
Operating frequency 2 rated value	60 Hz
relative negative tolerance of the operating frequency	-10 %
relative positive tolerance of the operating frequency	10 %
adjustable motor current	
• at rotary coding switch on switch position 1	200 A
• at rotary coding switch on switch position 2	218 A
• at rotary coding switch on switch position 3	236 A
• at rotary coding switch on switch position 4	254 A
• at rotary coding switch on switch position 5	272 A
• at rotary coding switch on switch position 6	290 A
• at rotary coding switch on switch position 7	308 A
• at rotary coding switch on switch position 8	326 A

<ul style="list-style-type: none"> • at rotary coding switch on switch position 9 • at rotary coding switch on switch position 10 • at rotary coding switch on switch position 11 • at rotary coding switch on switch position 12 • at rotary coding switch on switch position 13 • at rotary coding switch on switch position 14 • at rotary coding switch on switch position 15 • at rotary coding switch on switch position 16 • minimum 	344 A 362 A 380 A 398 A 416 A 434 A 452 A 470 A 200 A
minimum load [%]	15 %; Relative to smallest settable le
power loss [W] for rated value of the current at AC	
<ul style="list-style-type: none"> • at 40 °C after startup • at 50 °C after startup • at 60 °C after startup 	56 W 44 W 37 W
power loss [W] at AC at current limitation 350 %	
<ul style="list-style-type: none"> • at 40 °C during startup • at 50 °C during startup • at 60 °C during startup 	5 344 W 4 438 W 3 876 W
type of the motor protection	Electronic, tripping in the event of thermal overload of the motor
Control circuit/ Control	
type of voltage of the control supply voltage	AC
control supply voltage at AC	
<ul style="list-style-type: none"> • at 50 Hz • at 60 Hz 	110 ... 250 V 110 ... 250 V
relative negative tolerance of the control supply voltage at AC at 50 Hz	-15 %
relative positive tolerance of the control supply voltage at AC at 50 Hz	10 %
relative negative tolerance of the control supply voltage at AC at 60 Hz	-15 %
relative positive tolerance of the control supply voltage at AC at 60 Hz	10 %
control supply voltage frequency	50 ... 60 Hz
relative negative tolerance of the control supply voltage frequency	-10 %
relative positive tolerance of the control supply voltage frequency	10 %
control supply current in standby mode rated value	30 mA
holding current in bypass operation rated value	105 mA
inrush current by closing the bypass contacts maximum	2.2 A
inrush current peak at application of control supply voltage maximum	12.2 A
duration of inrush current peak at application of control supply voltage	2.2 ms
design of the overvoltage protection	Varistor
design of short-circuit protection for control circuit	4 A gG fuse (I _{cu} =1 kA), 6 A quick-acting fuse (I _{cu} =1 kA), C1 miniature circuit breaker (I _{cu} = 600 A), C6 miniature circuit breaker (I _{cu} = 300 A); Is not part of scope of supply
Inputs/ Outputs	
number of digital inputs	1
number of digital outputs	3
<ul style="list-style-type: none"> • not parameterizable 	2
digital output version	2 normally-open contacts (NO) / 1 changeover contact (CO)
number of analog outputs	1
switching capacity current of the relay outputs	
<ul style="list-style-type: none"> • at AC-15 at 250 V rated value • at DC-13 at 24 V rated value 	3 A 1 A
Installation/ mounting/ dimensions	
mounting position	with vertical mounting surface +/-90° rotatable, with vertical mounting surface +/- 22.5° tiltable to the front and back
fastening method	screw fixing
height	230 mm
width	160 mm
depth	282 mm

required spacing with side-by-side mounting	
<ul style="list-style-type: none"> • forwards • backwards • upwards • downwards • at the side 	10 mm 0 mm 100 mm 75 mm 5 mm
weight without packaging	7.3 kg
Connections/ Terminals	
type of electrical connection	
<ul style="list-style-type: none"> • for main current circuit • for control circuit 	busbar connection spring-loaded terminals
width of connection bar maximum	35 mm; with connection cover 3RT1966-4EA1 maximum length 45 mm
type of connectable conductor cross-sections	
<ul style="list-style-type: none"> • for main contacts for box terminal using the front clamping point solid • for main contacts for box terminal using the front clamping point finely stranded with core end processing • for main contacts for box terminal using the front clamping point finely stranded without core end processing • for main contacts for box terminal using the front clamping point stranded • for main contacts for box terminal using the back clamping point solid • for AWG cables for main contacts for box terminal using the back clamping point • for main contacts for box terminal using both clamping points solid • for main contacts for box terminal using both clamping points finely stranded with core end processing • for main contacts for box terminal using both clamping points finely stranded without core end processing • for main contacts for box terminal using both clamping points stranded • for main contacts for box terminal using the back clamping point finely stranded with core end processing • for main contacts for box terminal using the back clamping point finely stranded without core end processing • for main contacts for box terminal using the back clamping point stranded 	95 ... 300 mm ² 70 ... 240 mm ² 70 ... 240 mm ² 95 ... 300 mm ² 120 ... 240 mm ² 250 ... 500 kcmil min. 2x 70 mm ² , max. 2x 240 mm ² min. 2x 50 mm ² , max. 2x 185 mm ² min. 2x 50 mm ² , max. 2x 185 mm ² min. 2x 70 mm ² , max. 2x 240 mm ² 120 ... 185 mm ² 120 ... 185 mm ² 120 ... 240 mm ²
type of connectable conductor cross-sections	
<ul style="list-style-type: none"> • for AWG cables for main current circuit solid • for DIN cable lug for main contacts stranded • for DIN cable lug for main contacts finely stranded 	2/0 ... 500 kcmil 50 ... 240 mm ² 70 ... 240 mm ²
type of connectable conductor cross-sections	
<ul style="list-style-type: none"> • for control circuit solid • for control circuit finely stranded with core end processing • for AWG cables for control circuit solid • for AWG cables for control circuit finely stranded with core end processing 	2x (0.25 ... 1.5 mm ²) 2x (0.25 ... 1.5 mm ²) 2x (24 ... 16) 2x (24 ... 16)
wire length	
<ul style="list-style-type: none"> • between soft starter and motor maximum • at the digital inputs at AC maximum 	800 m 1 000 m
tightening torque	
<ul style="list-style-type: none"> • for main contacts with screw-type terminals • for auxiliary and control contacts with screw-type terminals 	14 ... 24 N·m 0.8 ... 1.2 N·m
tightening torque [lbf·in]	
<ul style="list-style-type: none"> • for main contacts with screw-type terminals • for auxiliary and control contacts with screw-type terminals 	124 ... 210 lbf·in 7 ... 10.3 lbf·in
Ambient conditions	
installation altitude at height above sea level maximum	5 000 m; derating as of 1000 m, see Manual
ambient temperature	
<ul style="list-style-type: none"> • during operation • during storage and transport 	-25 ... +60 °C; Please observe derating at temperatures of 40 °C or above -40 ... +80 °C

environmental category	<ul style="list-style-type: none"> during operation according to IEC 60721 during storage according to IEC 60721 during transport according to IEC 60721 	3K6 (no ice formation, only occasional condensation), 3C3 (no salt mist), 3S2 (sand must not get into the devices), 3M6 1K6 (only occasional condensation), 1C2 (no salt mist), 1S2 (sand must not get inside the devices), 1M4 2K2, 2C1, 2S1, 2M2 (max. fall height 0.3 m)			
EMC emitted interference	acc. to IEC 60947-4-2: Class A				
Communication/ Protocol					
communication module is supported	<ul style="list-style-type: none"> PROFINET standard EtherNet/IP Modbus RTU Modbus TCP PROFIBUS 	Yes Yes Yes Yes Yes			
UL/CSA ratings					
manufacturer's article number	<ul style="list-style-type: none"> of the fuse <ul style="list-style-type: none"> usable for Standard Faults up to 575/600 V according to UL usable for High Faults up to 575/600 V according to UL 	Type: Class L, max. 1600 A; Iq = 30 kA Type: Class L, max. 1200 A; Iq = 100 kA			
operating power [hp] for 3-phase motors	<ul style="list-style-type: none"> at 200/208 V at 50 °C rated value at 220/230 V at 50 °C rated value at 460/480 V at 50 °C rated value at 575/600 V at 50 °C rated value 	150 hp 150 hp 350 hp 450 hp			
Safety related data					
protection class IP on the front according to IEC 60529	IP00; IP20 with cover				
touch protection on the front according to IEC 60529	finger-safe, for vertical contact from the front with cover				
ATEX					
certificate of suitability	<ul style="list-style-type: none"> ATEX IECEX UKEX 	Yes Yes Yes			
hardware fault tolerance according to IEC 61508 relating to ATEX	0				
PFDAvg with low demand rate according to IEC 61508 relating to ATEX	0.09				
PFHD with high demand rate according to EN 62061 relating to ATEX	9E-6 1/h				
Safety Integrity Level (SIL) according to IEC 61508 relating to ATEX	SIL1				
T1 value for proof test interval or service life according to IEC 61508 relating to ATEX	3 a				
Certificates/ approvals					
General Product Approval		For use in hazardous locations			
	Confirmation				
For use in hazardous locations		Declaration of Conformity	Test Certificates	Marine / Shipping	
	Explosion Protection Certificate			Type Test Certificates/Test Report	
Marine / Shipping		other			

Further information

Siemens has decided to exit the Russian market (see here).

<https://press.siemens.com/global/en/pressrelease/siemens-wind-down-russian-business>

Siemens is working on the renewal of the current EAC certificates.

Please contact your local Siemens office on the status of validity of the EAC certification if you intend to import or offer to supply these products to an EAC relevant market (other than the sanctioned EAEU member states Russia or Belarus).

Information on the packaging

<https://support.industry.siemens.com/cs/ww/en/view/109813875>

Information- and Downloadcenter (Catalogs, Brochures,...)

<https://www.siemens.com/ic10>

Industry Mall (Online ordering system)

<https://mall.industry.siemens.com/mall/en/en/Catalog/product?mlfb=3RW5076-2AB15>

Cax online generator

<http://support.automation.siemens.com/WWW/CAXorder/default.aspx?lang=en&mlfb=3RW5076-2AB15>

Service&Support (Manuals, Certificates, Characteristics, FAQs,...)

<https://support.industry.siemens.com/cs/ww/en/ps/3RW5076-2AB15>

Image database (product images, 2D dimension drawings, 3D models, device circuit diagrams, EPLAN macros, ...)

http://www.automation.siemens.com/bilddb/cax_de.aspx?mlfb=3RW5076-2AB15&lang=en

Characteristic: Tripping characteristics, I^t, Let-through current

<https://support.industry.siemens.com/cs/ww/en/ps/3RW5076-2AB15/char>

Characteristic: Installation altitude

<http://www.automation.siemens.com/bilddb/index.aspx?view=Search&mlfb=3RW5076-2AB15&objecttype=14&gridview=view1>

Simulation Tool for Soft Starters (STS)

<https://support.industry.siemens.com/cs/ww/en/view/101494917>

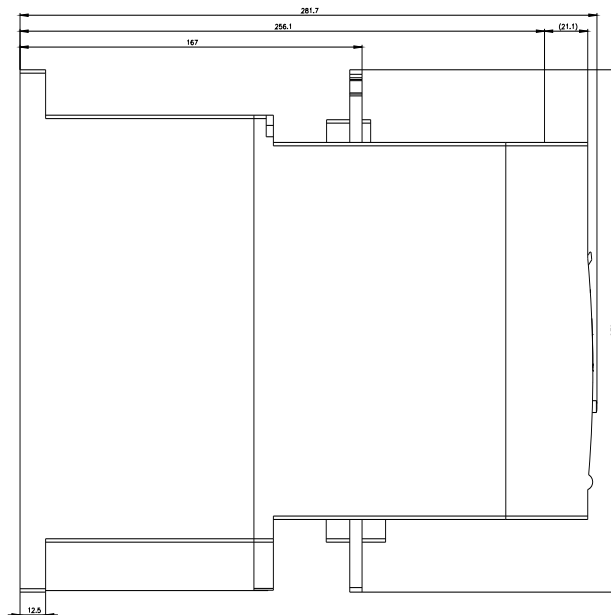
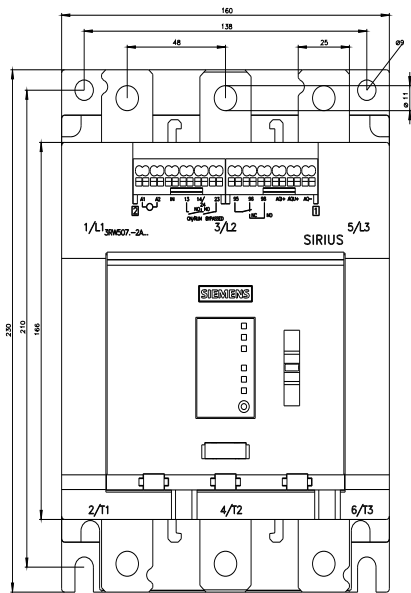

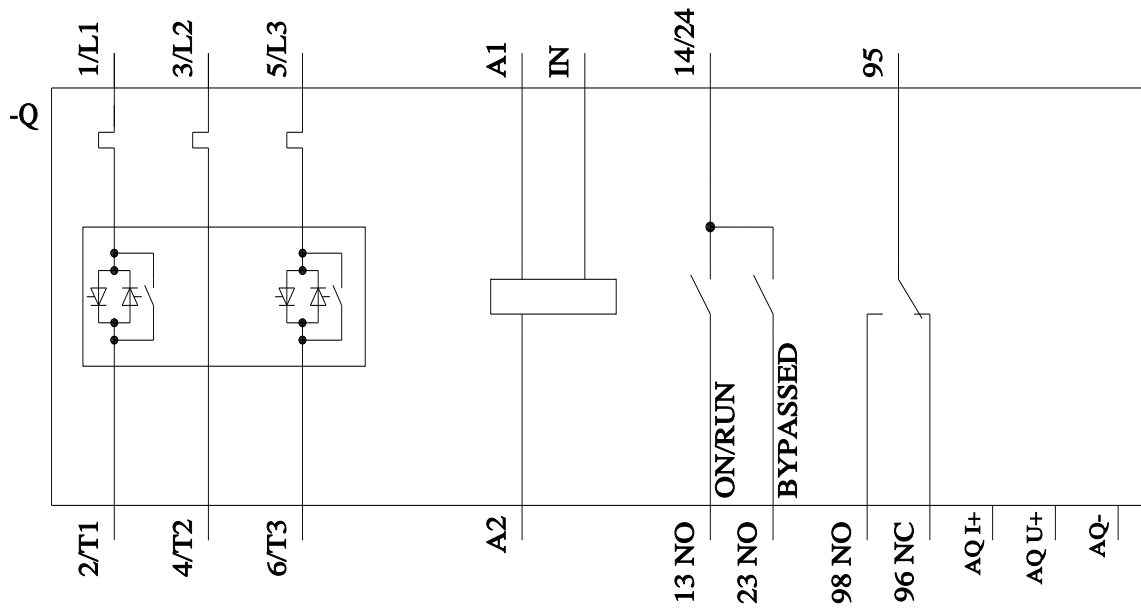

last modified:

1/14/2023 

