

# MACX MCR-EX-SL-SD-24-48-LP - Solenoid driver



2865609

<https://www.phoenixcontact.com/us/products/2865609>

Please be informed that the data shown in this PDF document is generated from our online catalog. Please find the complete data in the user documentation. Our general terms of use for downloads are valid.



Ex i solenoid driver. For the intrinsically safe control of Ex i solenoid valves, alarm modules or LEDs installed in the Ex area. Current limitation at 48 mA. For gases up to Group IIC, loop-powered, electrical isolation, SIL 3. Screw connection.

## Your advantages

- Mechanically compatible with the DIN rail connector
- Various output characteristic curves compatible with standard solenoid valves
- Loop-powered: the required power is supplied via the control signal on the input side.
- Installation in zone 2, protection type "n" (EN 60079-15) permitted
- Up to SIL 3 in accordance with IEC 61508
- 2-way electrical isolation
- Input: 19.2 V DC ... 30 V DC
- Output: [Ex ia] IIC/[Ex ia] IIB

## Commercial data

Item number	2865609
Packing unit	1 pc
Minimum order quantity	1 pc
Sales key	C430
Product key	CK3142
Catalog page	Page 167 (C-5-2019)
GTIN	4046356158411
Weight per piece (including packing)	175.93 g
Weight per piece (excluding packing)	113.7 g
Customs tariff number	85437090
Country of origin	DE

# MACX MCR-EX-SL-SD-24-48-LP - Solenoid driver



2865609

<https://www.phoenixcontact.com/us/products/2865609>

## Technical data

### Product properties

Product type	Solenoid driver
Product family	MACX Analog
No. of channels	1
Type	Ex i signal conditioners with SIL functional safety
Compatible valve	ASCO Coil 195
	ASCO Coil 302 (12 V)
	Bürkert Coil AC 10 standard
	Bürkert Coil AC 10 high resistance
	Bürkert Coil AC 21 standard 700 mW / 65°C
	Bürkert Coil AC 21 high resistance 700 mW / 65°C
	Bürkert Coil AC 21 standard 900 mW / 45°C
	Bürkert Coil AC 21 high resistance 900 mW / 45°C
	Bürkert Coil AC 21 standard 900 mW / 60°C
	Bürkert Coil AC 21 high resistance 900 mW / 60°C
	Bürkert Coil G1 642735 standard 800 mW / 40°C
	Bürkert Coil G1 642735 high resistance 800 mW / 40°C
	Bürkert Coil G1 642735 standard 1000 mW / 40°C
	Bürkert Coil G1 642735 high resistance 1000 mW / 40°C
	FESTO Coil MFH-...IA-SA-EX GBXE022AIAD03
	FESTO Coil (J)MFH-...BIA-SA-EX GBXE022AIAD03
	Norgren Herion Coil 2050
	Norgren Herion Coil 2051
	Norgren Herion Coil 2052
	Norgren Herion Coil 2053
	Norgren Herion Coil 2080 / 2082
	Norgren Herion Coil 2081 / 2083
	Norgren Herion Coil 2084
	Norgren Herion Coil 3039
	Nass Coil 1259 30.1-00
	Nass Coil 1259 50.1-00
	Parker Coil VZ07 488650.01
	Parker Coil VZ33 494035.10
	Parker Coil VZ08 488660.01
	Parker Coil VZ09 488670.01
	Parker Coil VZ95 482160.01 EEx ia IIB T6
	Parker Coil VZ23 482870.01
	Samson Coil 3701-12 (12 V)
	Samson Coil 3701-13 (24 V)
	Samson Coil 3963-12 (12 V)
	Samson Coil 3963-13 (24 V)

# MACX MCR-EX-SL-SD-24-48-LP - Solenoid driver



2865609

<https://www.phoenixcontact.com/us/products/2865609>

	Samson Coil 3964-12 (12 V)
	Samson Coil 3964-13 (24 V)
	Seitz Pilot valve PV 12F73 Ci oH
	Seitz Pilot valve PV 12F73 Xi oH
	Seitz Pilot valve PV 12F73 Xi oH-2
	Seitz Solenoid coil 11 G 52
Note	This is an extract of possible combinations of valves and solenoid drivers.

## Electrical properties

Electrical isolation	2-way isolation
Maximum temperature coefficient	0.01 %/K

### Electrical isolation

Test voltage	2.5 kV AC (50 Hz, 60 s)
Overvoltage category	II
Pollution degree	2

### Electrical isolation Output/input IEC/EN 60079-11

Standards/regulations	IEC/EN 60079-11
Rated insulation voltage	375 V <sub>PP</sub>

### Electrical isolation Output/input IEC/EN 61010-1

Standards/regulations	IEC/EN 61010-1
Rated insulation voltage	300 V <sub>rms</sub>
Insulation	Safe isolation

### Supply

Supply voltage range	loop-powered, no external supply necessary
Power dissipation	< 1.41 W

## Input data

### Signal: Voltage

Number of inputs	1
Voltage input signal	19.2 V DC ... 30 V DC (24 V DC, -20 % ... +25 %)
Max. current input signal	85 mA (U <sub>e</sub> = 24 V DC)

## Output data

### Signal: Voltage

Output description	intrinsically safe
Number of outputs	1
Output voltage	10.5 V DC (48 mA)
Output resistor	275.7 Ω (Internal resistance R <sub>i</sub> )
Current limitation	48 mA
Response time	20 ms

# MACX MCR-EX-SL-SD-24-48-LP - Solenoid driver



2865609

<https://www.phoenixcontact.com/us/products/2865609>

Non-load voltage	24 V DC
Short-circuit-proof	yes

## Connection data

Connection method	Screw connection
Stripping length	7 mm
Screw thread	M3
Conductor cross section rigid	0.2 mm <sup>2</sup> ... 2.5 mm <sup>2</sup>
Conductor cross section flexible	0.2 mm <sup>2</sup> ... 2.5 mm <sup>2</sup>
Conductor cross section AWG	24 ... 14
Tightening torque	0.5 Nm ... 0.6 Nm

## Test socket

Max. diameter	2 mm
---------------	------

## Ex data

Ex installation (EPL)	Gc
	Div. 2
Ex i circuits (EPL)	Ga
	Da
	Ma
	Div. 1

## Safety data

Max. internal inductance $L_i$	negligible
Max. internal capacitance $C_i$	negligible
Max. output voltage $U_o$	27.7 V
Max. output current $I_o$	101 mA
Max. output power $P_o$	697 mW
Safety-related maximum voltage $U_m$	253 V AC
	125 V DC
IIB/IIIC (simple circuit): Max. external inductivity $L_o$ / Max. external capacitance $C_o$	17 mH / 0.663 $\mu$ F
IIC (simple circuit): Max. external inductivity $L_o$ / Max. external capacitance $C_o$	4 mH / 0.085 $\mu$ F
IIB/IIIC (mixed circuit): Max. external inductivity $L_o$ / Max. external capacitance $C_o$	10 mH / 250 nF, 5 mH / 250 nF, 1 mH / 350 nF, 0.1 mH / 663 nF
IIC (mixed circuit): Max. external inductivity $L_o$ / Max. external capacitance $C_o$	20 mH / 68 nF, 10 mH / 68 nF, 5 mH / 68 nF, 1 mH / 79 nF, 0.1 mH / 108 nF

## Signaling

Status display	Yellow LED (switching state / status, lights up when output circuit is active)
----------------	--

## Dimensions

# MACX MCR-EX-SL-SD-24-48-LP - Solenoid driver



2865609

<https://www.phoenixcontact.com/us/products/2865609>

Dimensional drawing	
Width	12.5 mm
Height	112.5 mm
Depth	113.7 mm
Depth NS 35/7,5	114.5 mm (Snapped onto DIN rail NS 35/7,5 in accordance with EN 60715)

## Material specifications

Color	gray (RAL 7042)
Flammability rating according to UL 94	V0 (Housing)
Housing material	PA 6.6-FR

## Environmental and real-life conditions

### Ambient conditions

Degree of protection	IP20 (not assessed by UL)
Ambient temperature (operation)	-40 °C ... 60 °C (Any mounting position)
Ambient temperature (storage/transport)	-40 °C ... 80 °C
Altitude	≤ 2000 m
Permissible humidity (operation)	10 % ... 95 % (non-condensing)

## Approvals

### CE

Certificate	CE-compliant
Note	and EN 61326

### ATEX

Identification	⊕ II (1) G [Ex ia Ga] IIC/IIB/IIA
	⊕ II (1) D [Ex ia Da] IIIC
	⊕ II 3 (1)G Ex nA [ia IIC Ga] IIC T4 Gc X
Certificate	IBExU 07 ATEX 1133X

### UKCA Ex (UKEX)

Identification	⊕ I (M1) [Ex ia Ma] I
	⊕ II (1) G [Ex ia Ga] IIC
	⊕ II (1) D [Ex ia Da] IIIC
	⊕ II 3 (1) Ex ec [ia Ga] IIC T4 Gc
Certificate	CML 22UKEX3526X

### IECEX

# MACX MCR-EX-SL-SD-24-48-LP - Solenoid driver



2865609

<https://www.phoenixcontact.com/us/products/2865609>

Identification	[Ex ia Ga] IIC/IIB/IIA
	[Ex ia Da] IIIC
	Ex nA [ia IIC Ga] IIC T4 Gc
Certificate	IECEX IBE 08.0002X

## CCC / China-Ex

Identification	[Ex ia Ga] IIC
	[Ex iaD]
	Ex nA [ia Ga] IIC T4 Gc
Certificate	NEPSI GYJ20.1316X

## UL, USA/Canada

Identification	UL 61010 Listed
	Class I, Div. 2, Groups A, B, C, D T4
	Class I, Div. 2, Groups IIC, IIB, IIA T4
	Associated apparatus for use in Class I, Division 1, Groups A,B,C,D
	Associated apparatus for use in Class II, Div.1 Groups E,F,G
	Associated apparatus for use in Class III, Division 1
Certificate	Associated apparatus for use in Class I, Zone 0,1,2, Groups IIC,IIB,IIA
	ⓈⓂⓂ C.D.-No 83104549

## UL, USA/Canada

Identification	Class I Div 2; IS for Class I, II, III Div 1
Certificate	ⓈⓂⓂ C.D.-No 83104549

## Shipbuilding approval

Certificate	DNV GL TAA000020C
-------------	-------------------

## Safety Integrity Level (SIL, IEC 61508)

Identification	3
----------------	---

## INMETRO

Identification	[Ex ia Ga] IIB/IIA
	[Ex ia Da] IIIC
	Ex nA [ia IIB Ga] IIC T4 Gc
Certificate	DNV 18.0115 X

## DNV GL data

Temperature	B
Humidity	B
Vibration	A
EMC	A
Enclosure	Required protection according to the Rules shall be provided upon installation on board

## EMC data

# MACX MCR-EX-SL-SD-24-48-LP - Solenoid driver



2865609

<https://www.phoenixcontact.com/us/products/2865609>

Noise immunity	EN 61000-6-2
Electromagnetic compatibility	Conformance with EMC directive
Noise emission	EN 61000-6-4

## Standards and regulations

Electrical isolation	2-way isolation
----------------------	-----------------

### GB Standard

Standards/regulations	GB 3836.1
	GB 3836.4
	GB 3836.8
	GB 3626.20
	GB 12476.1
	GB 12476.4

## Mounting

Mounting type	DIN rail mounting
---------------	-------------------

# MACX MCR-EX-SL-SD-24-48-LP - Solenoid driver



2865609

<https://www.phoenixcontact.com/us/products/2865609>

## Drawings

Dimensional drawing

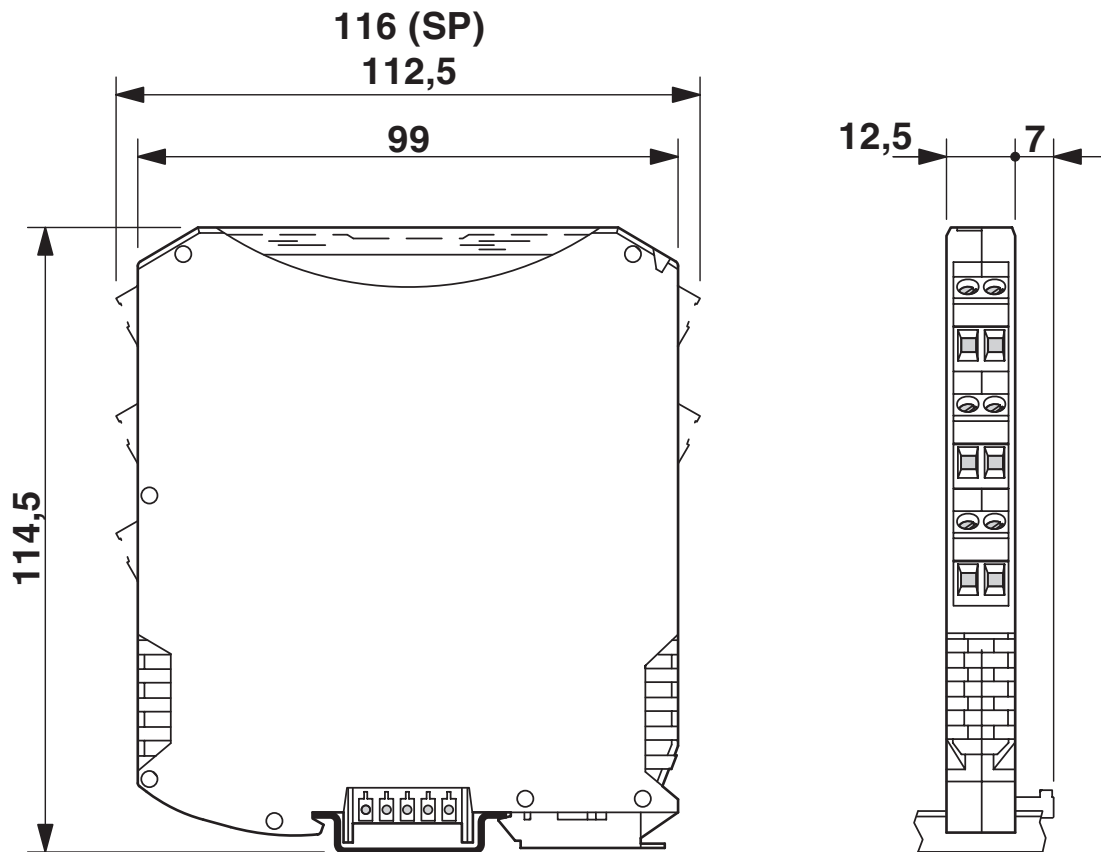



Block diagram

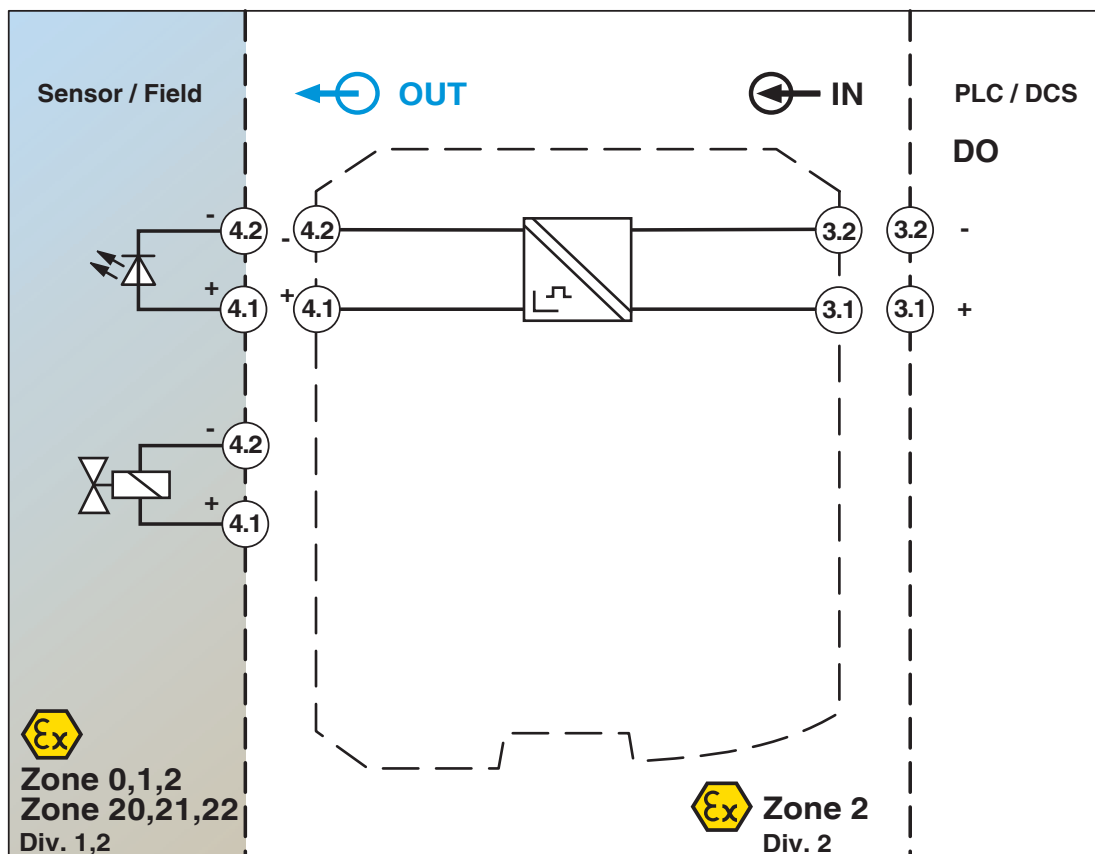

Diagram

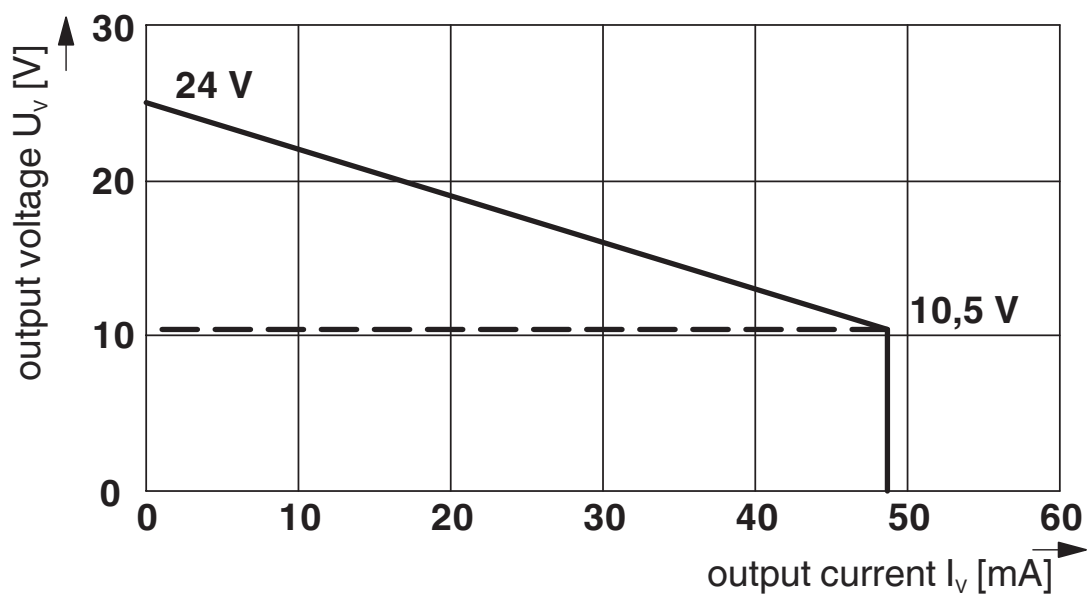

2865609

<https://www.phoenixcontact.com/us/products/2865609>

## Approvals

To download certificates, visit the product detail page: <https://www.phoenixcontact.com/us/products/2865609>



**DNV GL**

Approval ID: TAA000020C



**UL Listed**

Approval ID: FILE E 330267



**CCC**

Approval ID: 2020322 316001457



**cUL Listed**

Approval ID: FILE E 330267

**Functional Safety**

Approval ID: 16/04-017 R025 V1R1



**EAC Ex**

Approval ID: RU C-DE.AB72.B.00093



**IECEx**

Approval ID: IECEx IBE 08.0002X



**cUL Listed**

Approval ID: FILE E 199827



**UL Listed**

Approval ID: FILE E 199827



**ATEX**

Approval ID: IBExU 07 ATEX 1133 X

**INMETRO**

Approval ID: DNV 18.0115 X

# MACX MCR-EX-SL-SD-24-48-LP - Solenoid driver



2865609

<https://www.phoenixcontact.com/us/products/2865609>

**cULus Listed**

**cULus Listed**

# MACX MCR-EX-SL-SD-24-48-LP - Solenoid driver



2865609

<https://www.phoenixcontact.com/us/products/2865609>

## Classifications

### ECLASS

ECLASS-11.0	27210120
ECLASS-12.0	27210120
ECLASS-13.0	27210120

### ETIM

ETIM 9.0	EC002653
----------	----------

### UNSPSC

UNSPSC 21.0	39121000
-------------	----------

2865609

<https://www.phoenixcontact.com/us/products/2865609>

## Environmental product compliance

### EU RoHS

Fulfills EU RoHS substance requirements	Yes
Exemption	7(a), 7(c)-I

### China RoHS

Environment friendly use period (EFUP)	EFUP-50
	An article-related China RoHS declaration table can be found in the download area for the respective article under "Manufacturer declaration". For all articles with EFUP-E, no China RoHS declaration table issued and required.

### EU REACH SVHC

REACH candidate substance (CAS No.)	Lead(CAS: 7439-92-1)
SCIP	e426a61f-c59a-47a3-b935-75599b66e5fe

# MACX MCR-EX-SL-SD-24-48-LP - Solenoid driver



2865609

<https://www.phoenixcontact.com/us/products/2865609>

## Accessories

### TC-D37SUB-ADIO16-EX-P-UNI - Module carrier

2924854

<https://www.phoenixcontact.com/us/products/2924854>



Universal termination carrier for connecting 16 MACX Analog Ex i signal conditioners to digital or analog I/O cards, via D-SUB connector, 37-pos. (1:1 connection)

---

### MPS-IH WH - Insulating sleeve

0201663

<https://www.phoenixcontact.com/us/products/0201663>

Insulating sleeve, color: white



# MACX MCR-EX-SL-SD-24-48-LP - Solenoid driver

2865609

<https://www.phoenixcontact.com/us/products/2865609>



## MPS-IH RD - Insulating sleeve

0201676

<https://www.phoenixcontact.com/us/products/0201676>

Insulating sleeve, color: red



---

## MPS-IH BU - Insulating sleeve

0201689

<https://www.phoenixcontact.com/us/products/0201689>

Insulating sleeve, color: blue

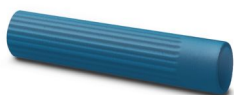

# MACX MCR-EX-SL-SD-24-48-LP - Solenoid driver

2865609

<https://www.phoenixcontact.com/us/products/2865609>



## MPS-IH YE - Insulating sleeve

0201692

<https://www.phoenixcontact.com/us/products/0201692>

Insulating sleeve, color: yellow



---

## MPS-IH GN - Insulating sleeve

0201702

<https://www.phoenixcontact.com/us/products/0201702>

Insulating sleeve, color: green





# MACX MCR-EX-SL-SD-24-48-LP - Solenoid driver

2865609

<https://www.phoenixcontact.com/us/products/2865609>



## MPS-IH GY - Insulating sleeve

0201728

<https://www.phoenixcontact.com/us/products/0201728>

Insulating sleeve, color: gray



---

## MPS-IH BK - Insulating sleeve

0201731

<https://www.phoenixcontact.com/us/products/0201731>

Insulating sleeve, color: black



# MACX MCR-EX-SL-SD-24-48-LP - Solenoid driver



2865609

<https://www.phoenixcontact.com/us/products/2865609>

## MPS-MT - Test plug

0201744

<https://www.phoenixcontact.com/us/products/0201744>



Test plug, with solder connection up to 1 mm<sup>2</sup> conductor cross section, number of positions: 1, color: gray

---

## UC-EMLP (11X9) - Plastic label

0819291

<https://www.phoenixcontact.com/us/products/0819291>



Plastic label, Sheet, white, unlabeled, can be labeled with: BLUEMARK ID COLOR, BLUEMARK ID, BLUEMARK CLED, PLOTMARK, CMS-P1-PLOTTER, mounting type: adhesive, lettering field size: 11 x 9 mm, Number of individual labels: 10

# MACX MCR-EX-SL-SD-24-48-LP - Solenoid driver



2865609

<https://www.phoenixcontact.com/us/products/2865609>

## UC-EMLP (11X9) YE - Plastic label

0822602

<https://www.phoenixcontact.com/us/products/0822602>

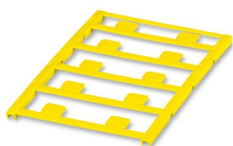

Plastic label, Sheet, yellow, unlabeled, can be labeled with: BLUEMARK ID COLOR, BLUEMARK ID, BLUEMARK CLED, PLOTMARK, CMS-P1-PLOTTER, mounting type: adhesive, lettering field size: 11 x 9 mm, Number of individual labels: 10

---

## UC-EMLP (11X9) CUS - Plastic label

0824547

<https://www.phoenixcontact.com/us/products/0824547>



Plastic label, can be ordered: by sheet, white, labeled according to customer specifications, mounting type: adhesive, lettering field size: 11 x 9 mm

# MACX MCR-EX-SL-SD-24-48-LP - Solenoid driver



2865609

<https://www.phoenixcontact.com/us/products/2865609>

## UC-EMLP (11X9) YE CUS - Plastic label

0824548

<https://www.phoenixcontact.com/us/products/0824548>

Plastic label, can be ordered: by sheet, yellow, labeled according to customer specifications, mounting type: adhesive, lettering field size: 11 x 9 mm

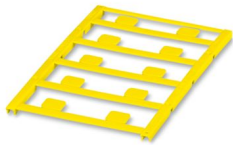

---

## UC-EMLP (11X9) SR - Plastic label

0828094

<https://www.phoenixcontact.com/us/products/0828094>

Plastic label, Sheet, silver, unlabeled, can be labeled with: BLUEMARK ID COLOR, BLUEMARK ID, BLUEMARK CLED, PLOTMARK, CMS-P1-PLOTTER, mounting type: adhesive, lettering field size: 11 x 9 mm, Number of individual labels: 10



# MACX MCR-EX-SL-SD-24-48-LP - Solenoid driver



2865609

<https://www.phoenixcontact.com/us/products/2865609>

## UC-EMLP (11X9) SR CUS - Plastic label

0828098

<https://www.phoenixcontact.com/us/products/0828098>



Plastic label, can be ordered: by sheet, silver, labeled according to customer specifications, mounting type: adhesive, lettering field size: 11 x 9 mm, Number of individual labels: 10

---

## US-EMLP (11X9) - Plastic label

0828789

<https://www.phoenixcontact.com/us/products/0828789>



Plastic label, Card, white, unlabeled, can be labeled with: BLUEMARK ID COLOR, BLUEMARK ID, THERMOMARK PRIME, THERMOMARK CARD 2.0, THERMOMARK CARD, mounting type: adhesive, lettering field size: 11 x 9 mm, Number of individual labels: 135

# MACX MCR-EX-SL-SD-24-48-LP - Solenoid driver



2865609

<https://www.phoenixcontact.com/us/products/2865609>

## US-EMLP (11X9) YE - Plastic label

0828871

<https://www.phoenixcontact.com/us/products/0828871>



Plastic label, Card, yellow, unlabeled, can be labeled with: BLUEMARK ID COLOR, BLUEMARK ID, THERMOMARK PRIME, THERMOMARK CARD 2.0, THERMOMARK CARD, mounting type: adhesive, lettering field size: 11 x 9 mm, Number of individual labels: 135

---

## US-EMLP (11X9) SR - Plastic label

0828872

<https://www.phoenixcontact.com/us/products/0828872>



Plastic label, Card, silver, unlabeled, can be labeled with: BLUEMARK ID COLOR, BLUEMARK ID, THERMOMARK PRIME, THERMOMARK CARD 2.0, THERMOMARK CARD, mounting type: adhesive, lettering field size: 11 x 9 mm, Number of individual labels: 135

# MACX MCR-EX-SL-SD-24-48-LP - Solenoid driver



2865609

<https://www.phoenixcontact.com/us/products/2865609>

## LS-EMLP (11X9) WH - Device marker

0831678

<https://www.phoenixcontact.com/us/products/0831678>

Device marker, Sheet, white, unlabeled, can be labeled with: TOPMARK NEO, TOPMARK LASER, mounting type: adhesive, lettering field size: 11 x 9 mm, Number of individual labels: 255

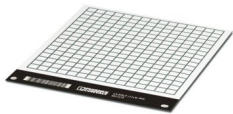

---

## LS-EMLP (11X9) SR - Device marker

0831705

<https://www.phoenixcontact.com/us/products/0831705>

Device marker, Sheet, silver, unlabeled, can be labeled with: TOPMARK NEO, TOPMARK LASER, mounting type: adhesive, lettering field size: 11 x 9 mm, Number of individual labels: 255

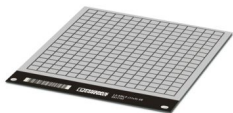

# MACX MCR-EX-SL-SD-24-48-LP - Solenoid driver



2865609

<https://www.phoenixcontact.com/us/products/2865609>

## LS-EMLP (11X9) YE - Device marker

0831732

<https://www.phoenixcontact.com/us/products/0831732>

Device marker, Sheet, yellow, unlabeled, can be labeled with: TOPMARK NEO, TOPMARK LASER, mounting type: adhesive, lettering field size: 11 x 9 mm, Number of individual labels: 255



---

## MACX MCR-PTB - Power and error message module

2865625

<https://www.phoenixcontact.com/us/products/2865625>

Power and fault signaling module with screw connection, including corresponding ME 17,5 TBUS 1,5/ 5-ST-3,81 GY DIN rail connector





# MACX MCR-EX-SL-SD-24-48-LP - Solenoid driver

2865609

<https://www.phoenixcontact.com/us/products/2865609>



## MACX MCR-PTB-SP - Power and error message module

2924184

<https://www.phoenixcontact.com/us/products/2924184>



Power and fault signaling module with Push-in connection, including corresponding ME 17,5 TBUS 1,5/ 5-ST-3,81 GY DIN rail connector

---

## QUINT4-SYS-PS/1AC/24DC/2.5/SC - Power supply unit

2904614

<https://www.phoenixcontact.com/us/products/2904614>



Primary-switched power supply, QUINT POWER, screw connection, DIN rail mounting, supply of devices possible via the TBUS DIN rail connector, protective coating, input: single-phase, output: 24 V DC/2.5 A

# MACX MCR-EX-SL-SD-24-48-LP - Solenoid driver



2865609

<https://www.phoenixcontact.com/us/products/2865609>

## SZS 0,6X3,5 - Screwdriver

1205053

<https://www.phoenixcontact.com/us/products/1205053>



Actuation tool, for ST terminal blocks, insulated, also suitable for use as a bladed screwdriver, size: 0.6 x 3.5 x 100 mm, 2-component grip, with non-slip grip

---

Phoenix Contact 2024 © - all rights reserved

<https://www.phoenixcontact.com>

Phoenix Contact USA  
586 Fulling Mill Road  
Middletown, PA 17057, United States  
(+717) 944-1300  
[info@phoenixcon.com](mailto:info@phoenixcon.com)