

1

2

3

4

5

6

7

A

A

B

B

C

C

D

D

E

E

F

F

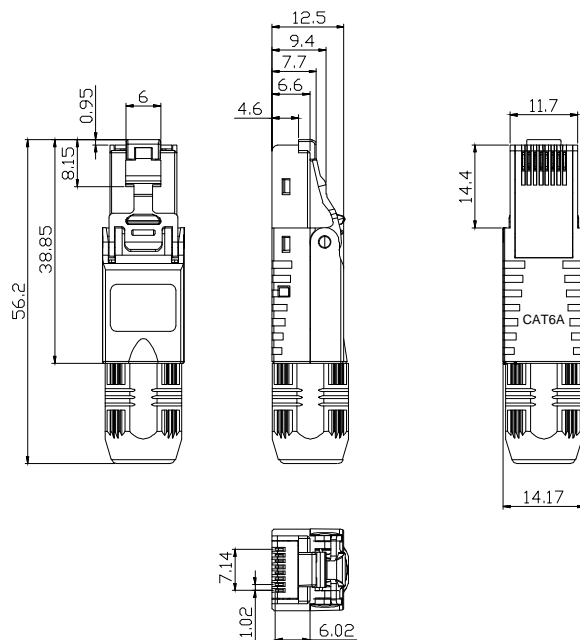
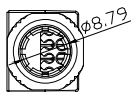
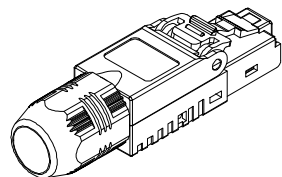

NOTES:

CAT6A RJ45 plug to be assembled in the field
 Suitable for power over Ethernet
 Load Bar for Faster and Easier Wire Pattern Termination
 Reconnectable

FTP TYPE: 1 Piece Design
 Easy Assembly: Easy terminated in the field in 2 minute without any special tools
 Anti-burn performance: Product made from PCB(FR-4), meeting the international standard.

Wire Connection: Stranded wire AWG 23 to 26; OD: 0.9-1.4mm

Cable jacket diameter: 5.0 to 9.0mm

Insulator: PC.PA
 Shell: Zinc Alloy
 IDC clip: phosphor bronze, Ni-plating
 Contact: Gold plating(see order code), phosphor bronze

Order Code: A-MJP-8-EG-xIB-S2
 H = 30u" Au
 L = 50u" Au

Mating durability: 750 cycles.
 Intensity of anti-currency: DC 1000V (AC 700V) /Minute

Operation temperature: -40°C to 85°C

RoHS compliant

Unit:mm

| | |
|-----------|-------|
| Scale | Free |
| TOLERANCE | |
| X.X | ±0.20 |
| X.XX | ±0.10 |
| X.XXX | ±0.05 |
| DIM | TOL |
| Angle | TOL |

| | | |
|----------|--------------|------|
| Drawn | Date | Name |
| Approved | 08.06.2021 | Luca |
| ① | 08.06.2021 | Luca |
| Id. | Modification | Date |
| | | Name |

ASSMANN
WSW components

| | |
|---|----------------|
| Description: Modular Connector RJ45 / CAT6A / Male | |
| ASSMANN WSW-No. A-MJP-8-EG-xIB-S2 | |
| Drawing-No. ASS 8958 CO | rev00 |
| Customer-No. | SHEET 1 / 2 |

1

2

3

4

5

6

7

1

2

3

4

5

6

7

Instruction Manual:



1.Full set of Modular plug.

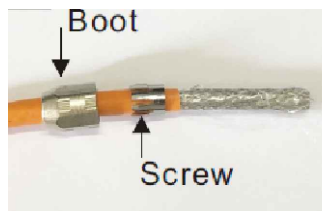

2.Strip off approx 5cm of the cable jacket. Put the cable through the boot and the screw.

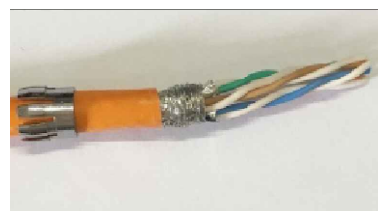

3.Strip off individual shielding. Make the earth grounding around the cable.



4.Make copper foil paper winding on the earth grounding wire.

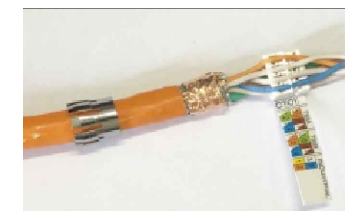

5.Insert the wires on the cap according to T568A or T568B.



6.Cut the extra wires until the horizontal line.Move the screw on the top of copper foil paper.



7.Put the termination cap onto the IDC Part & Tear off the color code paper. Make the termination cap on the right way.



8.Press the shielded cover to jack.Make secure contact with cable.

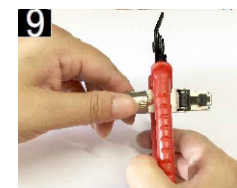

9.Tighten the boot on the back of connector



10.Installation is complete.

RoHS compliant

Unit:mm

Scale Free

TOLERANCE

X.X ±0.20

X.XX ±0.10

X.XXX ±0.05

DIM TOL

Angle TOL

①

Drawn

08.06.2021

Luca

Id.

Modification

Date

Name

Date

Name

Description: Modular Connector
RJ45 / CAT6A / Male

ASSMANN WSW-No.

A-MJP-8-EG-xIB-S2

Drawing-No.

ASS 8958 CO

rev00

Customer-No.

SHEET
2 / 2

1

2

3

4

5

6

7

SV5067