



Optional Green LED Display

4 1/2 DIGIT with 0.56" LEDs
in a NEMA type 1 Style Case

General Features

The UM-45-DCA is an economical, high resolution DC voltage measuring meter with three header selectable full scale ranges of 20mV, 50mV, 100mV and 200mV. A five position Span Adjust header facilitates scaling in engineering units.

The meter is particularly suited for measuring DC current using 50mV standard current shunts. The ability to accurately measure shunts with even lower voltage drops can produce substantial energy savings, for example 10mV can display 5000 Amps. Display Hold and Display Test functions are also provided.

Typical Application Connections

DC Current measurement using a 50mV Shunt.
Easily user scaled to display currents up to 1999 Amps.

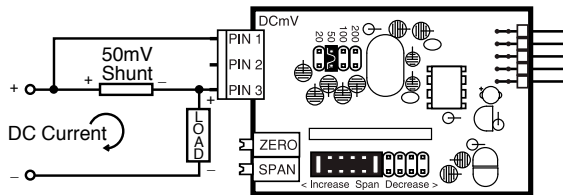

Shunt may be in Hi or Lo side of Load.

DC mV measurement with a resolution of 100 microVolts.
Easily user scaled to display voltages up to 199.9 mV.

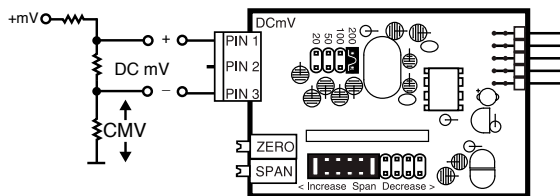

Can be used to measure single-ended or differential inputs.
Max CMV (common mode voltage) is 50V*.
Because CMV is common with meter ground, higher CMV inputs to a max of 1KV require mechanical isolation of all contactable meter parts.

UM-45-DCA

20/50/100/200mV DC Full Scale Meter

Accepting DC signals as low as 50mV full scale, this meter can economically measure high DC Amps, using low voltage drop current shunts, or for other precision low DC mV measurements.

Specifications

Input Configuration:.....Single-ended, however isolated power supply enables differential measurements up to a maximum common mode of 50V.*
A Zero Potentiometer is provided that can offset the displayed reading ± 500 counts.

Full Scale Ranges:.....Three header selectable ranges of ± 50 mV DC, ± 100 mV DC & ± 200 mV DC full scale

Input Impedance:.....50K Ω /100K Ω /65K Ω in 50/100/200mV ranges

A/D Converter:.....16 bit dual slope

Accuracy:..... $\pm (0.05\%$ of reading + 3 digits)

Temp. Coefficient:.....100ppm/ $^{\circ}$ C (Typical)

Warm Up Time:.....2 minutes to specified accuracy

Conversion Rate:.....3 readings per second

Display:.....0.56" high efficiency LED

Display Hold and Test Function

Polarity:.....Bipolar. Assumed +, displays -

Decimal Selection:.....Header under face plate, X \cdot X \cdot X \cdot X \cdot

Overload Indication:.....When input exceeds the full scale on any range being used, the meter displays flashing "0000"

Power Supply (std):.....120/240V AC, 50/60 Hz. approx 2.5W.

(Optn) VO-DC/ISO.....Isolated Switcher. 9 to 36V DC/12 to 24V AC

(Optn) VO-24V.....Isolated Transformer 24V AC $\pm 10\%$

Operating Temp.:..... -10 to 50° C

Storage Temperature:..... -20 to 70° C.

Relative Humidity:.....95% (non condensing)

Case Dimensions:.....Bezel 3.78"Wx1.89"H (96Wx48Hmm)
Depth behind bezel 3.67" (93.1 mm) Plus 0.5 to .9" (12.7 to 22.8mm) depending on connector used.

Weight:.....10 oz., 13 oz when packed.

UM-Series low cost utility meters for switchboard and process indication

UM-35-ACAAC amps, Scaled or True RMS, (1 or 5 Amp internal shunt), 3.5 digit.

UM-35-ACVAC volts, True RMS. 600V AC 3.5 digit.

UM-35-DCADC mV ± 20 mV/ ± 50 mV/ ± 100 mV/ ± 200 mV header selectable ranges, 3.5 digit

UM-35-DCVDC Volts ± 2 V/ ± 20 V/ ± 200 V DC header selectable ranges, 3.5 digit.

UM-40-ACAAC amps, Scaled or True RMS, (1 or 5 Amp internal shunt), 4.0 digit.

UM-40-ACVAC volts, True RMS. 600V AC 4.0 digit.

UM-45-DCADC mV ± 20 mV/ ± 50 mV/ ± 100 mV/ ± 200 mV header selectable ranges, 4.5 digit

UM-45-DCVDC Volts ± 2 V/ ± 20 V/ ± 200 V DC Header selectable ranges, 4.5 digit.

UM-35-CLProcess 4 to 20mA (100.0), easily user scalable in engineering units from -1999 to $+1999$. 3.5 digit

UM-35-HZ15Hz to 199.9Hz or optional 40Hz to 400Hz up to 500V AC, 3.5 digit.

UM-35-Pressure.....Pressure, strain gage and load cell, 4 and 6 wire, 5V DC excitation, Header Selectable Sensitivity 2mV/V, 5mV/V, 10mV/V, 20mV/V, 3.5 digit

UM-35-JF.....J thermocouple input, 1 $^{\circ}$ resolution, order $^{\circ}$ C or $^{\circ}$ F, 3.5 digit

UM-35-KF.....K thermocouple input, 1 $^{\circ}$ resolution, order $^{\circ}$ C or $^{\circ}$ F, 3.5 digit

UM-35-RTD/F.....100 Ω platinum RTD, 3 or 4 wire, order $^{\circ}$ C or $^{\circ}$ F and 0.1 $^{\circ}$ or 1 $^{\circ}$; 3.5 digit

UM-45-CLProcess 4 to 20mA (100.0), easily user scalable in engineering units from -19999 to $+19999$. 4.5 digit

Calibration Procedure

1. Select the required full scale voltage range, by repositioning the jumper clip on the range select header.
2. Apply an input of 0 millivolts. Adjust the zero offset pot until the meter reads 0000.
4. Apply a known high input signal that is within the full scale voltage range selected.
5. Adjust the Span Pot until the meter displays the required reading for the signal being applied.
6. The UM-45-DCA is now calibrated and ready for use.
(Whenever a new range is selected, re-calibration is required to meet the specified accuracy).

Decimal Point Selection

Decimal selection is made by moving the jumper to the indicated position on the header for the decimal required on the front of the display board.



To open meter, insert a flat head screwdriver or similar instrument in both slots on the side of the cover and pry open. The UM-Series meters slide out from the front of the case as a complete assembly.

Signal Conditioning Components

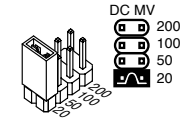

INPUT RANGE Header
Range values are marked on the PCB. After selecting a new range with the single jumper clip, recalibration is required.

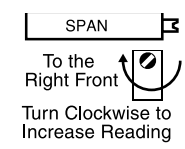

SPAN Potentiometer (Pot)
The 15 turn SPAN pot is always on the right side (as viewed from the front of the meter). Typical adjustment is 100% of the input signal range.

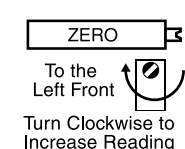

ZERO Potentiometer (Pot)
The Optional ZERO pot when installed is always to the left of the SPAN pot (as viewed from the front of the meter). Typically it enables the displayed reading to be offset ± 100 counts.

Optional Face Plate Descriptors

AC	V	KV	KVAR	m/hr	Hz	RPM
V	mV	min	PF	F	C	Cos ϕ
DC	x10kV	μ A	PSIG	mS	kg/cm 2	psi
kW	W	kWH	pH	%	K	kPa
A	mbar	mA	MW	kA	RPS	MW
mWs	μ m	kWs	l	l/sec	ml	cm
DRP	mm/s	l/min	mm	kg/sec	lbs	kg/hr
WT	bars	min	m/min	Mbars	μ V	dB

To customize the face plate, clear adhesive label containing various popular descriptors may be ordered. Choose the descriptor desired, peel off the adhesive backing and align the descriptor in the center right of the faceplate.
P.N.: 75-DESCRIPTR

Component Layout

Optional Isolated auto-sensing
AC/DC 9 to 36V DC / 12 to 24V AC
P.N.: PS7

110/120 VAC Selection header
200/240 VAC Selection header

Span Adjust Potentiometer
Zero Adjust Potentiometer

Span Adjust Header
Range Select Header

SPAN Adjust Header position	1	2	3	4	5
SPAN Pot %	10%	10%	10%	10%	10%
Signal Span %	20%	40%	60%	80%	100%

Connector Pinouts

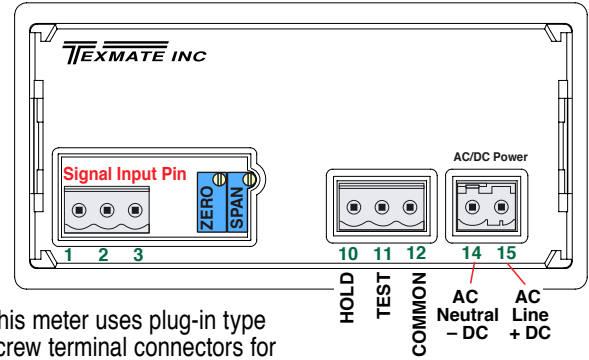

This meter uses plug-in type screw terminal connectors for all connections.

Connectors

This meter uses plug-in type screw terminal connectors for all input and output connections. The power supply connections (pins 14 and 15) have a unique plug and socket outline to prevent cross connection. The main board uses standard right-angled connectors.

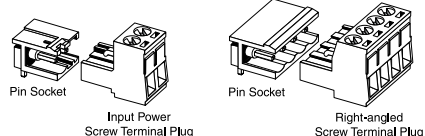

WARNING: AC and DC input signals and power supply voltages can be hazardous. Do Not connect live wires to screw terminal plugs, and do not insert, remove or handle screw terminal plugs with live wires connected.

UM Case Dimensions and Panel Cutouts

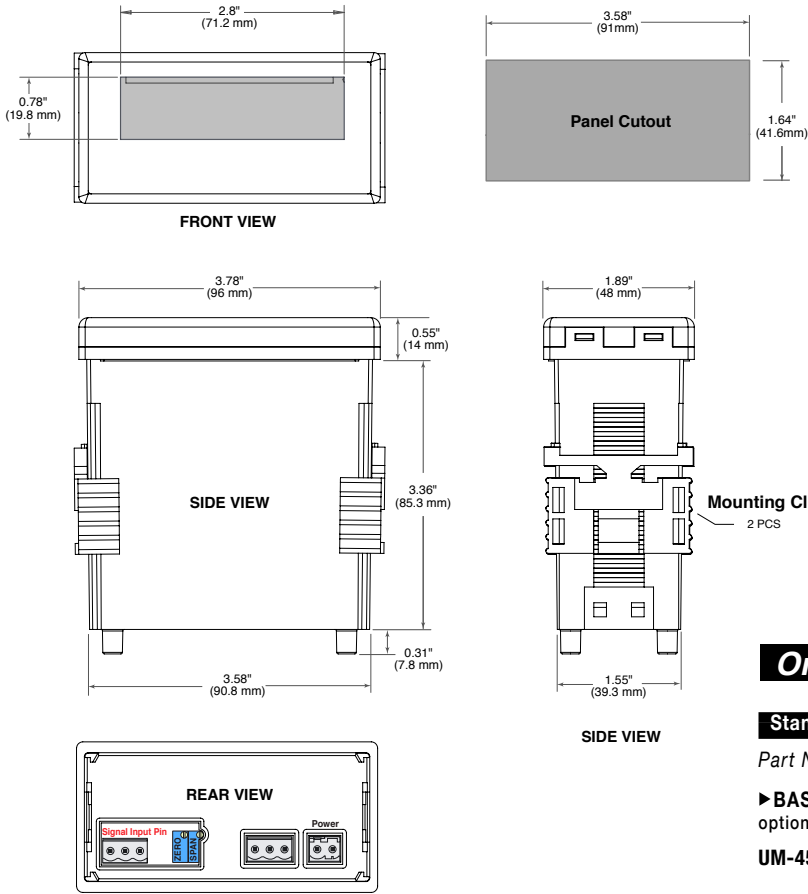

Clear Lockable Water-proof Cover

The clear lockable cover is designed to be dust and waterproof to NEMA-4X, IP65 standards. The assembly consists of a base and a cover with a cam hinge and key-lock fastening mechanism. An O-ring, or neoprene gasket forms a seal between the base and the panel. The cam hinge prevents the cover from closing when opened until pushed closed. The cover has a tapered recess that, when closed, forms a seal with a tapered spigot on the base. A key-lock employs a cam locking device to force the spigot into the recess, ensuring seal integrity. A safety catch keeps the cover closed even when the key is removed, and the keyhole can be used to attach a safety seal clip,

preventing unauthorized opening.

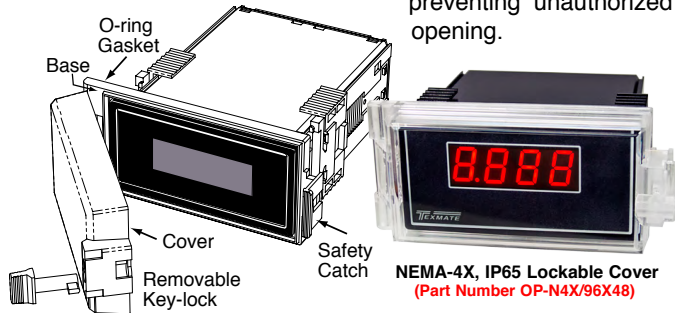

1934 Kellogg Ave., Carlsbad, CA 92008
Tel: 1-760-598-9899 • 1-800-TEXMATE
Fax: 1-760-598-9828 • Email: orders@texmate.com

Warranty and User's Responsibility

WARRANTY

Texmate warrants that its products are free from defects in material and workmanship under normal use and service for a period of one year from date of shipment. Texmate's obligations under this warranty are limited to replacement or repair, at its option, at its factory, of any of the products which shall, within the applicable period after shipment, be returned to Texmate's facility, transportation charges pre-paid, and which are, after examination, disclosed to the satisfaction of Texmate to be thus defective. The warranty shall not apply to any equipment which shall have been repaired or altered, except by Texmate, or which shall have been subjected to misuse, negligence, or accident. In no case shall Texmate's liability exceed the original purchase price. The aforementioned provisions do not extend the original warranty period of any product which has been either repaired or replaced by Texmate.

USER'S RESPONSIBILITY

We are pleased to offer suggestions on the use of our various products either by way of printed matter or through direct contact with our sales/application engineering staff. However, since we have no control over the use of our products once they are shipped, NO WARRANTY WHETHER OF MERCHANTABILITY, FITNESS FOR PURPOSE, OR OTHERWISE is made beyond the repair, replacement, or refund of purchase price at the sole discretion of Texmate. Users shall determine the suitability of the product for the intended application before using, and the users assume all risk and liability whatsoever in connection therewith, regardless of any of our suggestions or statements as to application or construction. In no event shall Texmate's liability, in law or otherwise, be in excess of the purchase price of the product.

Texmate cannot assume responsibility for any circuitry described. No circuit patent or software licenses are implied. Texmate reserves the right to change circuitry, operating software, specifications, and prices without notice at any time.

Ordering Information

Standard Options for this Model Number

Part Number Description

► **BASIC MODEL NUMBER** standard display and standard power supply unless optional versions are ordered.

UM-45-DCA.... DPM, DC mV $\pm 20\text{mV}$, $\pm 50\text{mV}$, $\pm 100\text{mV}$, $\pm 200\text{mV}$
Header selectable ranges (ID02)

► DISPLAY

DR0.56" Red LEDs

UM-BRIGHT.....Super bright Red LEDs, 0.56 inch high

UM-GREEN.....Green LEDs, 0.56 inch high

► POWER SUPPLY

PS6100/120 or 200/240VAC 60/50Hz User selectable

PS7.....Isolated auto-sensing AC/DC 9 to 36V DC/12 to 24V AC

PS8.....5 VDC /200mA

Special Options and Accessories

Part Number Description

► **SPECIAL OPTIONS (Specify Inputs & Req. Reading)**

ZR.....Range Change from Standard Range shown in **BOLD**

ZS..... Custom display scaling within standard ranges

► ACCESSORIES

OP-N4X/96X48..96x48mm clear lockable front cover NEMA 4X, splash proof

CASE.RPUM...Case: Replacement with Accessories

75-DTP2X9624 Panel cutout metal trim plate 96x48mm

ART-NRC-DEC..NRC for Artwork & set-up Custom Faceplate and/or Descriptor

ART-FS1Produce & Install Custom Faceplate per meter - 1 color no-min

ART-FS2Produce & Install Custom Faceplate per meter - 2 color no-min

ART-FS3Produce & Install Custom Faceplate per meter - 3 color no-min

75-DESCRIPTR..Clear adhesive descriptors label for face plate

93-PLUG2P-DP...Extra Screw Terminal Connector, 2 Pin Power Plug

93-PLUG2P-DR...Extra Screw Terminal Connector, 2 Pin Plug

93-PLUG3P-DR..Extra Screw Terminal Connector, 3 Pin Plug

93-PLUG4P-DR..Extra Screw Terminal Connector, 4 Pin Plug

UM-45-DCA Technical Manual Copyright © 2020 Texmate Inc. All rights reserved. Published by: Texmate Inc. USA. Information in this Technical Manual is subject to change without notice due to correction or enhancement. The information described in this manual is proprietary to Texmate, Inc. and may not be copied, reproduced or transmitted, in whole or in part, in connection with the design, manufacture, or sale of apparatus, device or private label product without the express written consent of Texmate, Inc.