



Optional super bright LEDs



Optional Green Digit Display

Optional Custom Faceplate

**3 1/2 DIGIT with 0.56" LEDs in a NEMA type 1 Style Case**

## UM-35-RTD-C UM-35-RTD-C.1 UM-35-RTD-F UM-35-RTD-F.1

### 100ΩPt RTD Temperature Meter

**Cost effective 2, 3 or 4 wire utility temperature meter that accepts 100Ω Platinum RTD sensors.**

**Pre-calibrated in**

**°F or °C and has 0.1° or 1° resolution.**

### General Features

The UM-35RTD is a versatile and economical temperature meter, designed to accept 2 wire, 3 wire or 4 wire 100Ω Platinum RTD sensors. The meter is ordered factory calibrated for either a °C or °F readout, and a 0.1° or a 1° resolution. If required in the future, the user can recalibrate the meter on-site without any component changes by following the instructions on page 2 of this data sheet and utilizing the internal °C or °F and 0.1° or 1° resolution select headers.

### Typical Application Connections

#### Temperature Measurement with 3 Wire RTD

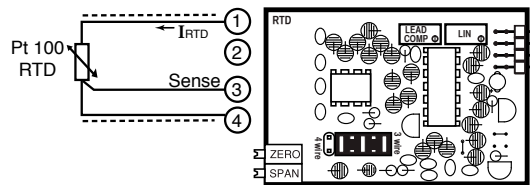

#### Temperature Measurement with 4 Wire RTD

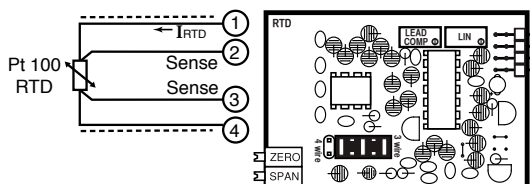

#### Temperature Measurement with 2 Wire RTD

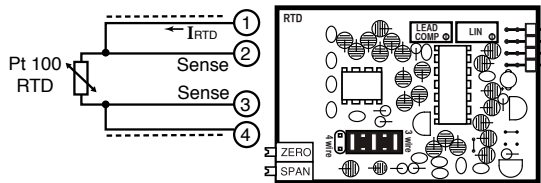

Sense input leads should be joined to the IRTD leads as close as possible to the sensor element because, on 2 wire RTDs, the single lead length resistance from the sensor to these joints will produce uncompensatable errors.

Excitation is 1mA. Up to 50 resistance in each lead can be compensated.

### Specifications

Input Configuration:.....3-Wire 100ΩPt RTD(0.00385Ω/Ω/°C)

Input Ranges:

UM-35-RTD-C.....-200°C to + 800°C (1°C resolution)

UM-35-RTD-C.1.....-199.9°C to + 199.9°C (0.1°C resolution)

UM-35-RTD-F.....-200°F to + 1470°F (1°F resolution)

UM-35-RTD-F.1.....-199.9°F to + 199.9°F (0.1°F resolution)

Lead Imbalance Error:.....2.8°C per ohm of imbalance

Lead Resistance:.....Up to 50Ω of resistance in each lead can be automatically compensated

Input Protection: .....25V AC/DC

A/D Converter:.....12 Bit Dual Slope

Accuracy:.....±(0.3% + 1 digit)

Temperature Coefficient: ...100 ppm/°C (Typical)

Warm Up Time: .....2 minutes

Conversion Rate:.....3 conversions per second (Typical)

Display:.....3 1/2 digit 0.56" Red LED display (std), (optn) Green or Super Bright Red, 0.8" Red or Green. Range 0 to 1999 counts.

Decimal Selection:.....Header under face plate, X•X•X•X•

Overrange Indication:.....1 (MSD) displayed all other digits blank

Power Supply (PS6 std):...Auto-sensing 85-305VAC or 120-430VDC, 50/60Hz App. 1W

(PS7 opt.) .Isolated (1.5kV) auto-sensing 9-36 VDC 1W

(PS11 opt.)..Isolated (1.5kV) auto-sensing 36-75 VDC 1W

(PS8 opt.) .5VDC/200mA

Operating Temperature: ....-10 to 50 °C

Storage Temperature:.....-20 to 70 °C.

Relative Humidity: .....95% (non-condensing)

Case Dimensions: .....Bezel 3.78"Wx1.89"H (96mm x 48mm)

Depth behind bezel 3.36" (83.5mm) Plus 0.5 to .9" (12.7 to 22.8mm) depending on connector used.

Weight: .....NW. 12oz (0.34kg) 15.6oz (0.44kg). when packed.

### UM-Series utility meters for switchboard and process indication

**UM-35-ACA** ....AC amps, True RMS, (1 or 5 Amp internal shunt), 3.5 digit.

**UM-35-ACV** ....AC volts, True RMS. 199.9V AC/700V AC header selectable ranges, 3.5 digit.

**UM-35-DCA** ....DC mV ±20mV/±50mV/ ±100mV/±200mV header selectable ranges, 3.5 digit

**UM-35-DCV** ....DC Volts ±2V/±20V/±200V DC header selectable ranges, 3.5 digit.

**UM-40-ACV** ....AC volts, True RMS. 199.9V AC/700V AC header selectable ranges, 4.0 digit.

**UM-45-DCA** ....DC mV ±20mV/±50mV/ ±100mV/±200mV header selectable ranges, 4.5 digit

**UM-45-DCV** ....DC Volts ±2V/±20V/±200V DC Header selectable ranges, 4.5 digit.

**UM-35-CL** .....Process 4 to 20mA (100.0), easily user scalable in engineering units from -1999 to +1999. 3.5 digit

**UM-35-HZ** .....15Hz to 199.9Hz or optional 40Hz to 400Hz up to 500V AC , 3.5 digit.

**UM-35-SG** .....Pressure, strain gage and load cell, 4 and 6 wire, 5V DC excitation, Header Selectable Sensitivity 2mV/V, 5mV/V, 10mV/V, 20mV/V, 3.5 digit

**UM-35-JF** .....J thermocouple input, 1° resolution, order °C or °F, 3.5 digit

**UM-35-KF** .....K thermocouple input, 1° resolution, order °C or °F, 3.5 digit

**UM-45-CL** .....Process 4 to 20mA (100.0), easily user scalable in engineering units from -19999 to +19999. 4.5 digit

## Decimal Point Selection

Decimal selection is made by moving the jumper to the indicated position on the header for the decimal required on the front of the display board.

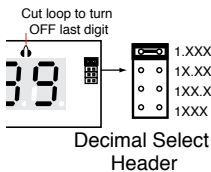

To open meter, insert a flat head screwdriver or similar instrument in both slots on the side of the cover and pry open. The UM-Series meters slide out from the front of the case as a complete assembly.

## Calibration Procedure

1. Select a 3 or 4 wire input configuration, with the 3 wire/4 wire Select Header. Note: Lead Compensation can only be calibrated in the 3 wire positioning. After calibration, the 4 wire mode can be selected without further calibration.
2. Connect an RTD Simulator to the input of the UM-35-RTD and calibrate according to the Calibration Table below..

Calibration Table	1C	1F
3. Adjust Zero Pot so display matches RTD simulator with output set to:	0C	0F
4. Adjust Span Pot so display matches RTD simulator with output set to:	-190C	-190F
5. Adjust Linearity Pot so display matches RTD simulator with output set to: Repeat Step 4 and 5 until both readings remain constant.	800C	1470F
6. Introduce an equal resistance of not more than 50 between each input of the RTD simulator and the meter. Adjust the Lead Compensation Pot so display matches RTD simulator with output set to:	The Lead Compensation is calibrated at the factory for lead resistances up to 50 each, and usually does not need to be re-calibrated.	
	800°C	1470°F

7. The UM-35-RTD meter is now calibrated and ready for use.

## Signal Conditioning Components

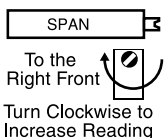

### SPAN Potentiometer (Pot)

The 15 turn SPAN pot is always on the right side (as viewed from the front of the meter). Typical adjustment is 100% of the input signal range.

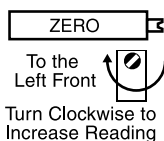

### ZERO Potentiometer (Pot)

The Optional ZERO pot when installed is always to the left of the SPAN pot (as viewed from the front of the meter). Typically it enables the displayed reading to be offset  $\pm 100$  counts.

## Component Layout

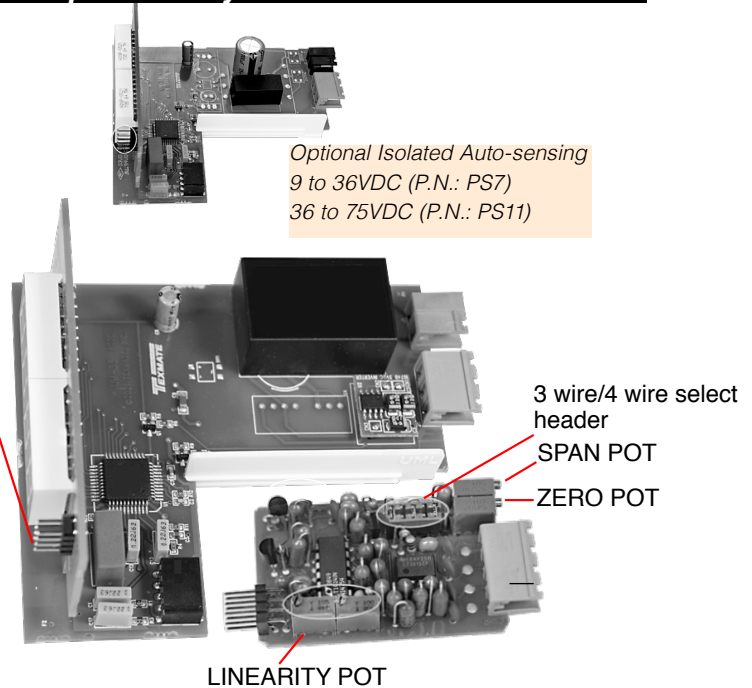

## Connector Pinouts

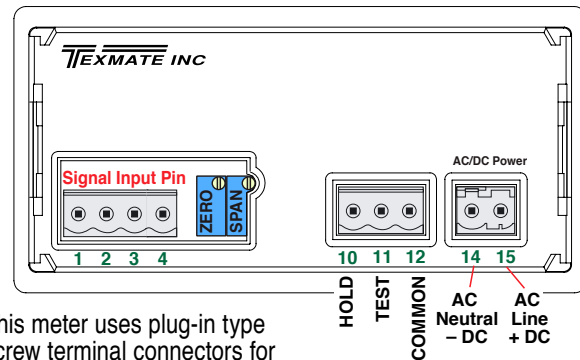

This meter uses plug-in type screw terminal connectors for all connections.

## Connectors

This meter uses plug-in type screw terminal connectors for all input and output connections. The power supply connections (pins 14 and 15) have a unique plug and socket outline to prevent cross connection. The main board uses standard right-angled connectors.

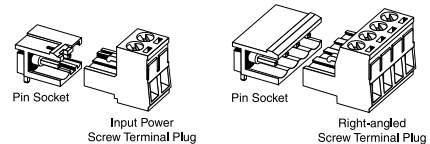

**WARNING:** AC and DC input signals and power supply voltages can be hazardous. Do Not connect live wires to screw terminal plugs, and do not insert, remove or handle screw terminal plugs with live wires connected.

## Optional Face Plate Descriptors

AC	V	kV	kVAR	m/nr	Hz	RPM
V	mV	min	PF	F	C	cos $\phi$
DC	x10kV	$\mu$ A	PSIG	mS	kg/cm $^2$	psi
kW	W	KWH	pH	%	K	kPa
A	mbar	mA	MW	kA	RPS	MWH
mWs	$\mu$ m	kW/s	l	l/sec	ml	cm
DRP	mm/s	$\mu$ min	mm	kg/sec	lbs	kg/hr
BT	bars	min	m/min	Mbars	$\mu$ V	dB

To customize the face plate, clear adhesive label containing various popular descriptors may be ordered. Choose the descriptor desired, peel off the adhesive backing and align the descriptor in the center right of the faceplate.

P.N.: 75-DESCRIPTR

## UM Case Dimensions and Panel Cutouts

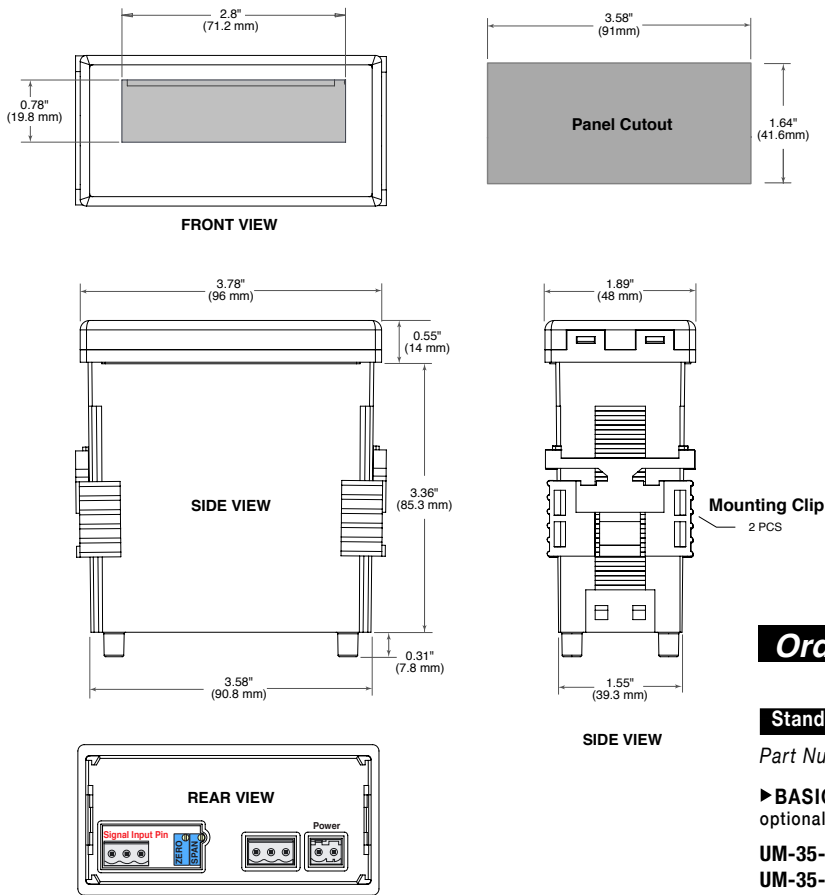

## Clear Lockable Water-proof Cover

The clear lockable cover is designed to be dust and waterproof to NEMA-4X, IP65 standards. The assembly consists of a base and a cover with a cam hinge and key-lock fastening mechanism. An O-ring, or neoprene gasket forms a seal between the base and the panel. The cam hinge prevents the cover from closing when opened until pushed closed. The cover has a tapered recess that, when closed, forms a seal with a tapered spigot on the base. A key-lock employs a cam locking device to force the spigot into the recess, ensuring seal integrity. A safety catch keeps the cover closed even when the key is removed, and the keyhole can be used to attach a safety seal clip,

preventing unauthorized opening.

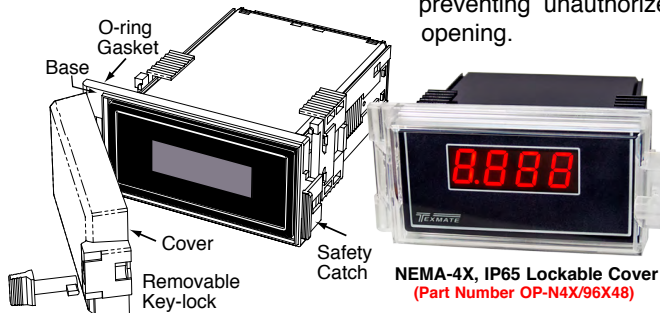

NEMA-4X, IP65 Lockable Cover  
(Part Number OP-N4X/96X48)



1934 Kellogg Ave., Carlsbad, CA 92008  
Tel: 1-760-598-9899 • 1-800-TEXMATE • Email: orders@texmate.com

## Warranty and User's Responsibility

### WARRANTY

Texmate warrants that its products are free from defects in material and workmanship under normal use and service for a period of one year from date of shipment. Texmate's obligations under this warranty are limited to replacement or repair, at its option, at its factory, of any of the products which shall, within the applicable period after shipment, be returned to Texmate's facility, transportation charges pre-paid, and which are, after examination, disclosed to the satisfaction of Texmate to be thus defective. The warranty shall not apply to any equipment which shall have been repaired or altered, except by Texmate, or which shall have been subjected to misuse, negligence, or accident. In no case shall Texmate's liability exceed the original purchase price. The aforementioned provisions do not extend the original warranty period of any product which has been either repaired or replaced by Texmate.

### USER'S RESPONSIBILITY

We are pleased to offer suggestions on the use of our various products either by way of printed matter or through direct contact with our sales/application engineering staff. However, since we have no control over the use of our products once they are shipped, NO WARRANTY WHETHER OF MERCHANTABILITY, FITNESS FOR PURPOSE, OR OTHERWISE is made beyond the repair, replacement, or refund of purchase price at the sole discretion of Texmate. Users shall determine the suitability of the product for the intended application before using, and the users assume all risk and liability whatsoever in connection therewith, regardless of any of our suggestions or statements as to application or construction. In no event shall Texmate's liability, in law or otherwise, be in excess of the purchase price of the product.

Texmate cannot assume responsibility for any circuitry described. No circuit patent or software licenses are implied. Texmate reserves the right to change circuitry, operating software, specifications, and prices without notice at any time.

## Ordering Information

### Standard Options for this Model Number

Part Number	Description
<b>►BASIC MODEL NUMBER</b> standard display and standard power supply unless optional versions are ordered.	
UM-35-RTD-C..	-200°C to + 800°C (1°C resolution) IT03 . . . . .
UM-35-RTD-C.1	-199.9°C to + 199.9°C (0.1°C resolution) IT14 . . . . .
UM-35-RTD-F . .	-200°F to + 1470°F (1°F resolution) IT04 . . . . .
UM-35-RTD-F.1	-199.9°F to + 199.9°F (0.1°F resolution) IT05 . . . . .

### ►DISPLAY

DR .....	0.56" Red LEDs .....
UM-BRIGHT.....	Super bright Red LEDs, 0.56 inch high .....
UM-GREEN.....	Green LEDs, 0.56 inch high .....

### ►POWER SUPPLY

PS6 (Std.).....	85-305VAC or 120-430VDC, 50/60Hz, Approx.1W . . . . .
PS7.....	Isolated (1.5kV) 9-36VDC Approx.1W
PS11 .....	Isolated (1.5kV) 36-75VDC Approx.1W
PS8.....	5 VDC /200mA .....

### Special Options and Accessories

Part Number	Description
<b>►ACCESSORIES</b>	
OP-N4X/96X48.	96x48mm clear lockable front cover NEMA 4X, splash proof
NEMA.RPUM . .	Case: Replacement with Accessories .....
ART-NRC-DEC.	NRC for Artwork & set-up Custom Faceplate and/or Descriptor
ART-FS1 . . . . .	Produce & Install Custom Faceplate per meter - 1 color no-min
ART-FS2 . . . . .	Produce & Install Custom Faceplate per meter - 2 color no-min
ART-FS3 .....	Produce & Install Custom Faceplate per meter - 3 color no-min
75-DESCRIPTR	Clear adhesive descriptors label for face plate .....

## Custom Face Plates

Texmate Produces Thousands of Custom OEM Face Plates. Have Texmate Design and produce a Custom Face Plate for your next project!

• Custom face plates have a non-recurring artwork charge. A serial number is then assigned to each artwork to facilitate reordering.

UM-35-RTD Technical Manual Copyright © 2022 Texmate Inc. All rights reserved. Published by: Texmate Inc. USA. Information in this Technical Manual is subject to change without notice due to correction or enhancement. The information described in this manual is proprietary to Texmate, Inc. and may not be copied, reproduced or transmitted, in whole or in part, in connection with the design, manufacture, or sale of apparatus, device or private label product without the express written consent of Texmate, Inc.