

# DPM 942-FPSI

## 4-20mA Loop Meter with Programmable Backlighting

### ORDERING INFORMATION

Standard Instrument (panel meter, fixing kit, data sheet)      DPM 942-FPSI

### FEATURES

- 19mm (0.75") digit height
- Dual colour backlight with programmable status indication
- Open collector outputs that mirror the backlight status (with inverted output option)
- 5V supply voltage
- 4–20mA measurement range



The DPM 942-FPSI is a 3 ½ digit LCD current loop meter that can also be used for dual colour go-stop status indication. This functionality is ideal for simplifying monitoring applications, where an operator needs to know the status of the equipment at a glance. During standard operation the backlight is green, however if the reading goes beyond the user programmable thresholds, the display will turn red. Three open collector outputs are included, that indicate high, ok and low conditions. Both the backlight colour and outputs can be inverted.

Module setup is a simple operation using an eight-way DIP switch and two push buttons. No special tools or equipment are required.

### SPECIFICATIONS

	Minimum	Typical	Maximum	Unit
Accuracy (overall error)		0.05	0.1	% (±1 count)
Linearity			±1	count
Sample rate		3		samples/second
Hysteresis (high and low thresholds)		2		counts
Operating temperature range	0 (32)		50 (122)	°C (°F)
Temperature stability		100		ppm/°C
Supply voltage	4.5	5	5.5	V
Supply current (not including backlight)		1		mA
Backlight voltage		5		V
Backlight current			40	mA

# DPM 942-FPSI

## 4-20mA Loop Meter with Programmable Backlighting

### PIN FUNCTIONS

1. I-	Negative current loop input
2. I+	Positive current loop input
3. V-	Negative supply connection
4. V+	Positive supply connection
5. LP+	Positive backlight connection
6. ALM HI	Open collector alarm output. Goes low when the high threshold of the module has been passed.
7. ALM OK	Open collector alarm output. Goes low when the module is measuring a signal between the high and low thresholds.
8. ALM LO	Open collector alarm output. Goes low when the lower threshold of the module has been passed.
9. SW-	Negative switch input for flashing backlight acknowledgement.
10. SW+	Positive switch input for flashing backlight acknowledgement.

### LCD SYMBOLS

- 'Err' Return dip switches 1 to 5 to the off position. Only 1 of these switches may be in the on position at a time.
-  The unit is in set-up mode. To view the measured signal, ensure switches 1 to 5 are in the off position.

### DIMENSIONS

All dimensions in mm (inches)

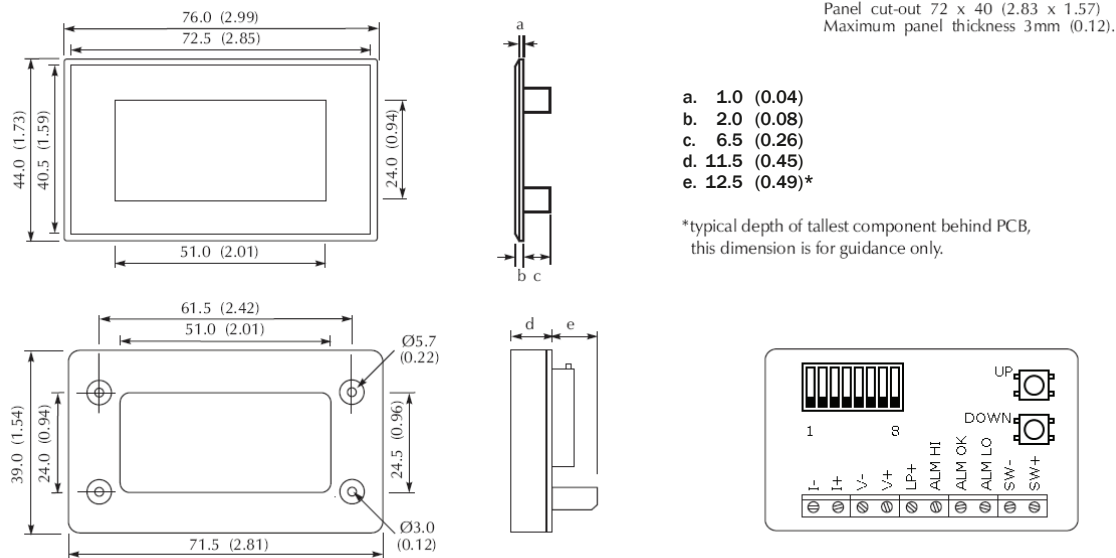

# DPM 942-FPSI

## 4-20mA Loop Meter with Programmable Backlighting

### DIP SWITCH CONFIGURATION

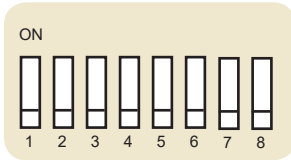

1. Enter offset calibration mode
2. Enter span calibration mode
3. Enter high threshold setup mode
4. Enter low threshold setup mode
5. Enter decimal place setup mode
6. Invert alarm operation
7. Invert outputs
8. Select backlight supply

### OFFSET AND SPAN CALIBRATION

Calibration is performed in two steps. The first step is to adjust the offset value. The second is to adjust the span.

To adjust the offset, move DIP 1 to the 'on' position and input a known constant current (typically 4mA). By default, 000 will be displayed. The user can then use the 2 push buttons mounted on the rear of the device to adjust the value on the display. Pressing the 'up' button once will increase the value on the LCD by one count. Pressing the 'down' button once will decrease the value on the LCD by one count.

If either button is held down, the value will continuously change until the button is released again. When the desired value is on the display, return DIP 1 to the 'off' position.

To adjust the span, move DIP 2 to the 'on' position and input a known current (typically 20mA). By default 1000 will be displayed. The value can then be adjusted in the same way as the offset.

### THRESHOLD SETUP

There are two independent thresholds on the unit which control the backlight colour and open-collector outputs. The high threshold is triggered when exceeded by the input signal and the low threshold is triggered when the input signal drops below it. Both thresholds can be set, enabled and disabled independently.

By default the backlighting is green when an input is normal and red when the input exceeds a threshold (see INVERT BACKLIGHT COLOURS for more information). The thresholds can be set to any value between -1999 and 1999, however, it is not possible to assign a value to the low threshold which exceeds that of the high threshold and vice versa. In addition to numerical values, it is also possible to set both values to an 'over range' condition. This will only trigger the backlight when the input goes beyond a value that can be displayed.

To adjust the threshold calibration:

First select a position on the miniature DIP switch, mounted on the reverse of the module.

- Moving position 3 to 'on' will display the high threshold value
- Moving position 4 to 'on' will display the low threshold value

When a threshold is selected, it can then be adjusted using the two push buttons mounted on the rear of the device. The thresholds are adjusted as shown overleaf.

# DPM 942-FPSI

## 4-20mA Loop Meter with Programmable Backlighting

High threshold:

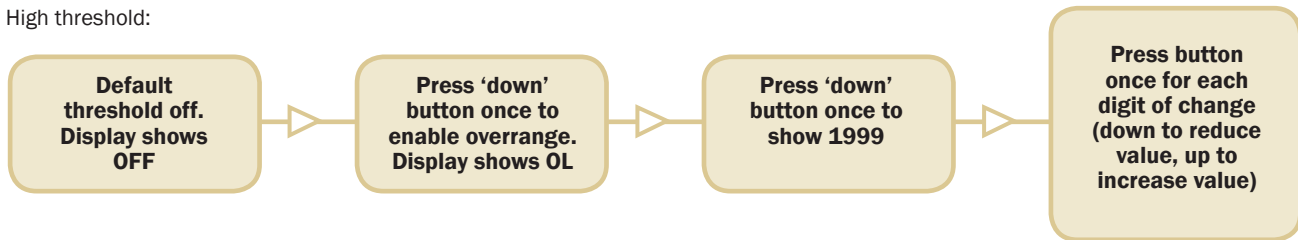

Low threshold:

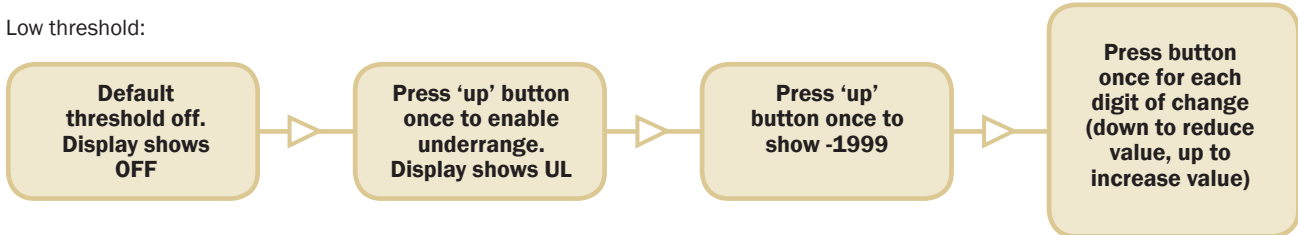

When the DIP switches are returned to the 'on' positions the display shows the current loop value, as defined by the offset and span settings previously programmed.

In standard operation, the high and low thresholds have a hysteresis value of two counts. This only applies when going from an alarm condition to a non-alarm condition (i.e. the signal has to go at least 2 counts into the non-alarm condition before the backlight will return to green). This is to prevent flickering and unnecessary repeat alarms.

### DECIMAL PLACE AND LEADING ZERO SELECTION

The position of the decimal point and number of leading zeros is changed by setting DIP switch '5' to the 'on' position and using the up and down buttons on the rear of the module. The decimal point has three possible positions as well as an 'off' option. The leading zeros can be set to one (the user can select the decimal point position and the leading zero will move accordingly) or 'all on'. Return DIP switch '5' to the 'on' position before installing the module in the application.

### INVERT ALARMS

The red and green backlighting and three alarm outputs can be inverted by moving DIP switch 6 to the 'on' position.

### INVERT OUTPUTS

Changing DIP switch 7 to 'on' inverts the three alarms outputs. i.e. the output that was previously on is now off, and the two outputs that were previously off are now on. This can be used in conjunction with DIP switch 6 to set the outputs back to the 'original' position.

### SELECT BACKLIGHT SUPPLY

V+ and LP+ share a common ground (V-). By default, V+ and LP+ are not connected. Moving DIP switch 8 to the 'on' position connects LP+ directly to V+, removing the need for a separate supply.

### FLASHING BACKLIGHT

By default, the backlight will flash red when an alarm threshold is exceeded. Temporarily connecting the SW+ and SW- inputs will stop the flashing (the backlight will remain red however). The backlight will not flash again, until the alarm has cleared (i.e. returned to green) and another threshold is exceeded.

Connecting a wire link permanently between SW+ and SW- will disabled flashing and the backlight will remain as a solid colour.

# DPM 942-FPSI

## 4-20mA Loop Meter with Programmable Backlighting

### FACTORY RESET

Module calibration can be reset to the factory default by moving all 8 dip switches to 'on' and powering up the unit. The LCD will display 4 dashes when the reset is complete. Moving all the dip switches back to the 'off' position will return the module to the operating mode.

### SAFETY

To comply with the Low Voltage Directive (LVD 93/68/EEC), input voltages to the module's pins must not exceed 60V d.c. If voltages to the measuring inputs do exceed 60V d.c., then fit scaling resistors externally to the module. The user must ensure that the incorporation of the DPM into the user's equipment conforms to the relevant sections of BS EN 61010 (Safety Requirements for Electrical Equipment for Measuring, Control and Laboratory Use).

### VARIOUS OPERATION MODES

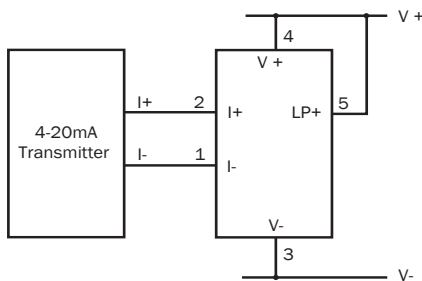

Measuring a current loop. The meter power supply should be isolated from the 4-20mA transmitter power supply

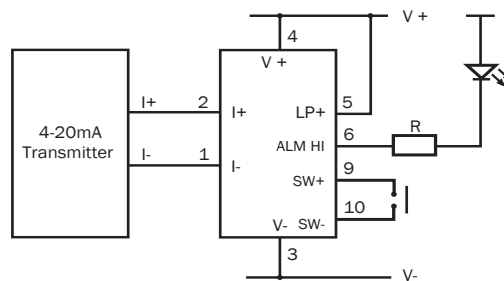

Using an external LED as a high alarm and a switch to acknowledge the alarm (to stop it flashing)